



N10GSM24XP

User Guide

Issue V7.4.7
Date 2023-08-29

Table of Contents

1 Preface	24
1.1 Declaration.....	24
1.2 Suggestion feedback.....	24
1.3 Audience.....	24
2 Basic Configuration Guide	25
2.1 Configuring System Management	25
2.1.1 Overview	25
2.1.2 Configuration.....	25
2.1.3 Application cases	28
2.2 Configuring User Management	28
2.2.1 Overview	28
2.2.2 Configuration.....	29
2.2.3 Application cases	31
2.3 Configuring FTP	31
2.3.1 Overview	31
2.3.2 Configuration.....	32
2.3.3 Application cases	33
2.4 Configuring FTP SERVER.....	33
2.4.1 Overview	33
2.4.2 Configuration.....	34
2.4.3 Application cases	35
2.5 Configuring TFTP	35
2.5.1 Overview	35
2.5.2 Configuration.....	36
2.5.3 Application cases	37
2.6 Configuring SCP	37
2.6.1 Overview	37
2.6.2 Configuration.....	37
2.6.3 Application cases	38
2.7 Configuring Telnet	38
2.7.1 Overview	38
2.7.2 Configuration.....	39
2.7.3 Application cases	40
2.8 Configuring SSH	40
2.8.1 Overview	40
2.8.2 Configuration.....	41

2.8.3 Application cases	42
2.9 Configuring Time&timezone.....	42
2.9.1 Overview	42
2.9.2 Configuration.....	43
2.9.3 Application cases	43
2.10 Configuring License	44
2.10.1 Overview	44
2.10.2 Configuration.....	44
2.11 RPC API Configuration Guide.....	45
2.11.1 Overview	45
2.11.2 Configuration.....	49
2.11.3 Application cases	50
2.12 Configuring HTTP	50
2.12.1 Overview	50
2.12.2 Configuration.....	51
2.12.3 Application cases	52
3 Ethernet Configuration Guide	53
3.1 Configuring Interface	53
3.1.1 Overview	53
3.1.2 Configuration.....	54
3.1.3 Application cases	56
3.2 Configuring Group-speed of Interfaces	57
3.2.1 Overview	57
3.2.2 Configuration.....	57
3.2.3 Application cases	58
3.3 Configuring Layer3 Interfaces.....	58
3.3.1 Overview	58
3.3.2 Configuration.....	59
3.4 Configuring Interface Errdisable.....	61
3.4.1 Overview	61
3.4.2 Configuration.....	62
3.4.3 Application cases	65
3.5 Configuring MAC Address Table.....	65
3.5.1 Overview	65
3.5.2 Configuration.....	66
3.5.3 Application cases	71
3.6 Configuring VLAN.....	71
3.6.1 Overview	71
3.6.2 Configuration.....	73

3.6.3 Application cases	76
3.7 Configuring Voice VLAN.....	76
3.7.1 Overview	76
3.7.2 Configuration	77
3.7.3 Application cases	78
3.8 Configuring VLAN Classification.....	78
3.8.1 Overview	78
3.8.2 Configuration	79
3.8.3 Application cases	81
3.9 Configuring VLAN Mapping.....	81
3.9.1 Overview	81
3.9.2 Configuration	83
3.9.3 Application cases	89
3.10 Configuring Link Aggregation	89
3.10.1 Overview	89
3.10.2 Configuration	90
3.10.3 Application cases	95
3.11 Configuring Flow Control.....	96
3.11.1 Overview	96
3.11.2 Configuration.....	96
3.11.3 Application cases	98
3.12 Configuring Storm Control.....	98
3.12.1 Overview	98
3.12.2 Configuration.....	99
3.12.3 Application cases	100
3.13 Configuring Loopback Detection	101
3.13.1 Overview	101
3.13.2 Configuration.....	101
3.13.3 Application cases	104
3.14 Configuring Layer 2 Protocols Tunneling	105
3.14.1 Overview	105
3.14.2 Configuration.....	105
3.14.3 Application cases	108
3.15 Configuring MSTP	108
3.15.1 Overview	108
3.15.2 Configuration.....	109
3.15.3 Application cases	114
3.16 Configuring MLAG	114
3.16.1 Overview	114
3.16.2 Configuration.....	115

3.16.3 Application cases	118
3.17 Configuring Hash Load-balance	118
3.17.1 Configuring Linkagg Hash.....	118
3.17.2 Configuring ECMP Hash.....	129
3.17.3 Configuring ECMP Hash.....	136
3.18 Configuring PORT-XCONNECT	137
3.18.1 Overview	137
3.18.2 Configuration.....	137
3.18.3 Application cases	138
4 IP Service Configuration Guide	139
4.1 Configuring Arp.....	139
4.1.1 Overview	139
4.1.2 Configuration.....	140
4.1.3 Application cases	142
4.2 Configuring Arp proxy.....	142
4.2.1 Overview	142
4.2.2 Configuration.....	143
4.2.3 Application cases	149
4.3 Configuring DHCP Client	149
4.3.1 Overview	149
4.3.2 Configuration.....	150
4.3.3 Application cases	151
4.4 Configuring DHCP Relay	152
4.4.1 Overview	152
4.4.2 Configuration.....	152
4.4.3 Application cases	154
4.5 Configuring DHCP server.....	155
4.5.1 Overview	155
4.5.2 Configuration.....	156
4.5.3 Application cases	161
4.6 Configuring DNS.....	161
4.6.1 Overview	161
4.6.2 Configuration.....	161
4.6.3 Application cases	162
5 IP Routing Configuration Guide	163
5.1 Configuring IP Unicast-Routing	163
5.1.1 Overview	163
5.1.2 Configuration.....	164
5.1.3 Application cases	167

5.2 Configuring RIP	167
5.2.1 Overview	167
5.2.2 Configuration	168
5.2.3 Application cases	193
5.3 Configuring OSPF	193
5.3.1 Overview	193
5.3.2 Configuration	194
5.3.3 Application cases	219
5.4 Configuring Prefix-list	222
5.4.1 Overview	222
5.4.2 Configuration	222
5.4.3 Application cases	226
5.5 Configuring Route-map	226
5.5.1 Overview	226
5.5.2 Configuration	227
5.5.3 Application cases	229
5.6 Configuring Policy-Based Routing	229
5.6.1 Overview	229
5.6.2 Configuration	230
5.6.3 Application cases	234
5.7 Configuring BGP	234
5.7.1 Overview	234
5.7.2 Configuration	235
5.7.3 Application cases	240
5.8 Configuring ISIS	240
5.8.1 Overview	240
5.8.2 Configuration	242
5.8.3 Application cases	246
6 Multicast Configuration Guide	247
6.1 Configuring IP Multicast-Routing	247
6.1.1 Overview	247
6.1.2 Configuration	247
6.1.3 Application cases	248
6.2 Configuring IGMP	248
6.2.1 Overview	248
6.2.2 Configuration	249
6.2.3 Application cases	252
6.3 Configuring PIM-SM	252
6.3.1 Overview	252

6.3.2 Configuration	256
6.3.3 Application cases	265
6.4 Configuring PIM-DM	265
6.4.1 Overview	265
6.4.2 Configuration	266
6.4.3 Application cases	268
6.5 Configuring IGMP Snooping	268
6.5.1 Overview	268
6.5.2 Configuration	270
6.5.3 Application cases	276
6.6 Configuring MVR	277
6.6.1 Overview	277
6.6.2 Configuration	278
6.6.3 Application cases	280
7 Security Configuration Guide	281
7.1 Configuring Port Security	281
7.1.1 Overview	281
7.1.2 Configuration	282
7.1.3 Application cases	283
7.2 Configuring Vlan Security	283
7.2.1 Overview	283
7.2.2 Configuration	284
7.2.3 Application cases	285
7.3 Configuring Time-Range	286
7.3.1 Overview	286
7.3.2 Configuration	286
7.3.3 Application cases	287
7.4 Configuring ACL	287
7.4.1 Overview	287
7.4.2 Configuration	288
7.4.3 Application cases	290
7.5 Configuring Extern ACL	290
7.5.1 Overview	290
7.5.2 Configuration	291
7.5.3 Application cases	293
7.6 Configuring IPv6 ACL	293
7.6.1 Overview	293
7.6.2 Configuration	294
7.6.3 Application cases	296

7.7 Configuring Port-Group	296
7.7.1 Overview	296
7.7.2 Configuration	296
7.7.3 Application cases	297
7.8 Configuring Vlan-Group	297
7.8.1 Overview	297
7.8.2 Configuration	297
7.8.3 Application cases	298
7.9 Configuring COPP ACL	298
7.9.1 Overview	298
7.9.2 Configuration	299
7.9.3 Application cases	301
7.10 Configuring dot1x	301
7.10.1 Overview	301
7.10.2 Configuration	302
7.10.3 Application cases	306
7.11 Configuring Guest VLAN	308
7.11.1 Overview	308
7.11.2 Configuration	309
7.11.3 Application cases	315
7.12 Configuring ARP Inspection	315
7.12.1 Overview	315
7.12.2 Configuration	317
7.12.3 Application cases	319
7.13 Configuring DHCP Snooping	319
7.13.1 Overview	319
7.13.2 Configuration	320
7.13.3 Application cases	322
7.14 Configuring IP source guard	322
7.14.1 Overview	322
7.14.2 Configuration	324
7.14.3 Application cases	325
7.15 Configuring Private-vlan	326
7.15.1 Overview	326
7.15.2 Configuration	326
7.15.3 Application cases	328
7.16 Configuring AAA	328
7.16.1 Overview	328
7.16.2 Configuration	329
7.16.3 Application cases	331

7.17 Configuring TACACS+	333
7.17.1 Overview	333
7.17.2 Configuration	334
7.17.3 Application cases	336
7.18 Configuring Port Isolate	337
7.18.1 Overview	337
7.18.2 Configuration	337
7.18.3 Application cases	338
7.19 Configuring DDoS	339
7.19.1 Overview	339
7.19.2 Configuration	340
7.19.3 Application cases	341
7.20 Configuring Key Chain	342
7.20.1 Overview	342
7.20.2 Configuration	342
7.20.3 Application cases	343
7.21 Configuring Port-Block	343
7.21.1 Overview	343
7.21.2 Configuration	344
7.21.3 Application cases	344
8 Device Management Configuration Guide	345
8.1 Configuring STM	345
8.1.1 Overview	345
8.1.2 Configuration	346
8.1.3 Application cases	347
8.2 Configuring syslog	347
8.2.1 Overview	347
8.2.2 Configuration	350
8.2.3 Application cases	352
8.3 Configuring mirror	352
8.3.1 Overview	352
8.3.2 Configuration	356
8.3.3 Application cases	367
8.4 Configuring Device Management	368
8.4.1 Overview	368
8.4.2 Configuration	368
8.4.3 Application cases	374
8.5 Configuring Bootrom	374
8.5.1 Overview	374

8.5.2 Configuration	375
8.5.3 Application cases	378
8.6 Configuring SmartConfig	378
8.6.1 Overview	378
8.6.2 Configuration	380
8.6.3 Application cases	381
8.7 Reboot Logs	382
8.7.1 Overview	382
8.7.2 Configuration	383
8.7.3 Application cases	383
9 Network Management Configuration Guide	384
9.1 Configuring Network Diagnosis	384
9.1.1 Overview	384
9.1.2 Configuration	385
9.1.3 Application cases	385
9.2 Configuring NTP	386
9.2.1 Overview	386
9.2.2 Configuration	386
9.2.3 Application cases	390
9.3 Configuring Phy Loopback	391
9.3.1 Overview	391
9.3.2 Configuration	392
9.3.3 Application cases	394
9.4 Configuring L2 ping	394
9.4.1 Overview	394
9.4.2 Configuration	395
9.4.3 Application cases	396
9.5 Configuring RMON	396
9.5.1 Overview	396
9.5.2 Configuration	397
9.5.3 Application cases	398
9.6 Configuring SNMP	398
9.6.1 Overview	398
9.6.2 Configuration	400
9.6.3 Application cases	404
9.7 Configuring SFLOW	404
9.7.1 Overview	404
9.7.2 Configuration	405
9.7.3 Application cases	407

9.8 Configuring LLDP	407
9.8.1 Overview	407
9.8.2 Configuration	408
9.9 Configuring IPFIX	410
9.9.1 Overview	410
9.9.2 Configuration	410
9.9.3 Application cases	413
9.10 PTP Configuration Guide.....	413
9.10.1 Overview	413
9.10.2 Default Configuration.....	414
9.10.3 Configurations	414
10 Traffic Management Configuration Guide	424
10.1 Configuring QoS.....	424
10.1.1 Overview	424
10.1.2 Configuration.....	432
10.1.3 Configuration for Queue	438
10.1.4 Configuration for Port shaping & port policing	443
10.1.5 Application cases	444
11 IPv6 Service Configuration.....	445
11.1 Configuring IPv6 over IPv4 Tunnel	445
11.1.1 Overview	445
11.1.2 Configuration.....	449
11.1.3 Application cases	463
11.2 Configuring ND.....	463
11.2.1 Overview	463
11.2.2 Configuration.....	464
11.2.3 Application cases	465
11.3 Configuring DHCPv6 Relay	465
11.3.1 Overview	465
11.3.2 Configuration.....	466
11.3.3 Application cases	468
12 IPv6 Security Configuration Guide	469
12.1 DHCPv6 Snooping Configuration	469
12.1.1 Overview	469
12.1.2 Configuration.....	469
12.1.3 Application cases	471
13 IPv6 Routing Configuration	472
13.1 Configuring IPv6 Unicast-Routing	472

13.1.1 Overview	472
13.1.2 Configuration.....	473
13.1.3 Application cases	475
13.2 Configuring OSPFv3.....	475
13.2.1 Overview	475
13.2.2 Configuration.....	476
13.2.3 Application cases	504
13.3 Configuring RIPng.....	504
13.3.1 Overview	504
13.3.2 Configuration.....	505
13.3.3 Application cases	521
13.4 Configuring Ipv6 Prefix-list.....	522
13.4.1 Overview	522
13.4.2 Configuration.....	522
13.4.3 Application cases	525
14 IPv6 Multicast Configuration Guide.....	526
14.1 Configuring IPv6 Multicast-Routing	526
14.1.1 Overview	526
14.1.2 Configuration.....	526
14.1.3 Application cases	527
14.2 Configuring MLD	527
14.2.1 Overview	527
14.2.2 Configuration.....	528
14.2.3 Application cases	531
14.3 Configuring PIMv6-SM	531
14.3.1 Overview	531
14.3.2 Configuration.....	535
14.3.3 Application cases	544
14.4 Configuring PIMv6-DM.....	545
14.4.1 Overview	545
14.4.2 Configuration.....	545
14.4.3 Application cases	548
14.5 Configuring MLD Snooping	548
14.5.1 Overview	548
14.5.2 Configuration.....	550
14.5.3 Application cases	557
14.6 Configuring MVR6	557
14.6.1 Overview	557
14.6.2 Configuration.....	558

14.6.3 Application cases	560
15 VPN Configuration Guide	561
15.1 Configuring VPN.....	561
15.1.1 Overview	561
15.1.2 Configuration.....	561
15.1.3 Application cases	562
15.2 Configuring IPv4 GRE Tunnel.....	563
15.2.1 Overview	563
15.2.2 Configuration.....	564
15.2.3 Application cases	567
16 Reliability Configuration Guide.....	568
16.1 Configuring BHM.....	568
16.1.1 Overview	568
16.1.2 Configuration.....	568
16.1.3 Application cases	569
16.2 Configuring EFM OAM.....	569
16.2.1 Overview	569
16.2.2 Configuration.....	570
16.2.3 Application cases	576
16.3 Configuring CFM	576
16.3.1 Overview	576
16.3.2 Configuration.....	578
16.3.3 Application cases	598
16.4 Configuring CPU Traffic	598
16.4.1 Overview	598
16.4.2 Configuration.....	602
16.4.3 Application cases	605
16.5 Configuring G.8031	605
16.5.1 Overview	605
16.5.2 Configuration.....	606
16.5.3 Application cases	608
16.6 Configuring G8032.....	608
16.6.1 Overview	608
16.6.2 Topology.....	609
16.6.3 Configuration of single ring.....	611
16.6.4 Configuration of multiple rings - Non-virtual-channel.....	615
16.6.5 Configuration of multiple rings - Virtual-channel.....	620
16.6.6 Linkage between G8032 and CFM.....	625
16.7 Configuring UDLD	631

16.7.1 Overview	631
16.7.2 Configuration.....	632
16.7.3 Application cases	633
16.8 Configuring ERPS	634
16.8.1 Overview	634
16.8.2 Configuration.....	634
16.8.3 Application cases	644
16.9 Configuring Smart Link.....	645
16.9.1 Overview	645
16.9.2 Configuration.....	645
16.9.3 Application cases	650
16.10 Configuring Multi-Link	650
16.10.1 Overview	650
16.10.2 Configuration.....	651
16.10.3 Application cases	654
16.11 Configuring Monitor Link.....	660
16.11.1 Overview	660
16.11.2 Configuration.....	660
16.11.3 Application cases	661
16.12 Configuring VRRP	661
16.12.1 Overview	661
16.12.2 Configuration.....	664
16.12.3 Application cases	683
16.13 Configuring Track.....	684
16.13.1 Overview	684
16.13.2 Configuration.....	685
16.13.3 Application cases	703
16.14 Configuring IP BFD	703
16.14.1 Overview	703
16.14.2 Configuration.....	704
16.14.3 Application cases	710
16.15 Configuring VARP.....	710
16.15.1 Overview	710
16.15.2 Configuration.....	710
16.15.3 Application cases	712
16.16 Configuring UDP Helper	712
16.16.1 Overview	712
16.16.2 Configuration.....	713
16.16.3 Application cases	714

17 Network Virtualization Configuration Guide	715
17.1 Configuring VXLAN	715
17.1.1 Overview	715
17.1.2 Configuration.....	715
17.2 Configuring NVGRE.....	736
17.2.1 Overview	736
17.2.2 Configuration.....	736
17.2.3 Application cases	743
17.3 Configuring GENEVE.....	743
17.3.1 Overview	743
17.3.2 Configuration.....	743
17.3.3 Application cases	750
17.4 Configuring Overlay	750
17.4.1 Overview	750
17.4.2 Configuration.....	750
17.4.3 Application cases	758
17.5 Configuring OVSDB	758
17.5.1 Overview	758
17.5.2 Configuration.....	761
17.5.3 Application cases	763
18 Intelligent Lossless Network Configuration Guide	764
18.1 Configuring Priority-based Flow Control.....	764
18.1.1 Overview	764
18.1.2 Configuration.....	765
18.1.3 Application cases	767
18.2 Configuring EFD	767
18.2.1 Overview	767
18.2.2 Configuration.....	768
18.2.3 Application cases	770
19 MPLS Configuration Guide	771
19.1 Configuring LDP	771
19.1.1 Overview	771
19.1.2 Configuration.....	772
19.2 Configuring MPLS.....	774
19.2.1 Overview	774
19.2.2 Configuration.....	775
19.2.3 Application cases	777
19.3 Configuring VPLS	777
19.3.1 Overview	777

19.3.2 Configuration.....	778
19.3.3 Application cases.....	793
19.4 Configuring VPWS.....	793
19.4.1 Overview.....	793
19.4.2 Configuration.....	794
19.4.3 Application cases.....	800
19.5 Configuring MPLS QoS.....	800
19.5.1 Overview.....	800
19.5.2 MPLS LSP Model.....	800
19.5.3 Configuration.....	802
19.5.4 Application cases.....	810
19.6 Configuring L3VPN.....	811
19.6.1 Overview.....	811
19.6.2 Configuration.....	811
19.6.3 Application cases.....	816
19.7 Configuring MPLS SR.....	816
19.7.1 Overview.....	816
19.7.2 Configuration.....	817
20 PoE.....	828
20.1 PoE Overview.....	828
20.2 features and configurations.....	828
20.2.1 Configuring Global PoE power management scheme.....	828
20.2.2 Configuring power-reserved.....	835
20.2.3 Configure threshold-power-percentage.....	836
20.2.4 Enable port PoE feature.....	836
20.2.5 Configuring the Power Supply Priority.....	836
20.2.6 Trigger an autotest measurement.....	837
20.3 Example for Configuring PoE.....	837

List of Figures

Figure 2-1 SSH system application	41
Figure 3-1 Interface Name.....	53
Figure 3-2 Mac address aging.....	66
Figure 3-3 Static mac address table	67
Figure 3-4 Static multicast mac address table.....	68
Figure 3-5 mac address filter.....	69
Figure 3-6 mac address filter with VLAN	70
Figure 3-7 Tagged Frame.....	72
Figure 3-8 Trunk link.....	72
Figure 3-9 Access link.....	72
Figure 3-10 Access link.....	73
Figure 3-11 Trunk link.....	74
Figure 3-12 vlan classification	79
Figure 3-13 QinQ Tunnel.....	82
Figure 3-14 vlan mapping	83
Figure 3-15 QinQ Tunnel.....	85
Figure 3-16 QinQ Tunnel.....	85
Figure 3-17 QinQ Tunnel.....	87
Figure 3-18 Dynamic LACP.....	90
Figure 3-19 Static LACP.....	92
Figure 3-20 Static Agg	94
Figure 3-21 Flow control.....	96
Figure 3-22 Percentage Storm Control	99
Figure 3-23 PPS Storm Control.....	100
Figure 3-24 L2 protocol tunnel.....	105
Figure 3-25 MSTP.....	109
Figure 3-26 MLAG	115
Figure 4-1 arp.....	140

Figure 4-2 arp proxy	143
Figure 4-3 local arp proxy	146
Figure 4-4 dhcp client	150
Figure 4-5 DHCP relay	152
Figure 4-6 DHCP server	156
Figure 4-7 DHCP relay	158
Figure 4-8 DNS	161
Figure 5-1 ip unicast routing.....	164
Figure 5-2 enable rip.....	168
Figure 5-3 rip version	170
Figure 5-4 rip metric	173
Figure 5-5 rip distance	176
Figure 5-6 rip redistribute	178
Figure 5-7 rip split-horizon.....	181
Figure 5-8 rip filter list	185
Figure 5-9 rip authentication	187
Figure 5-10 rip authentication.....	190
Figure 5-11 ospf.....	195
Figure 5-12 ospf priority	198
Figure 5-13 ospf area	201
Figure 5-14 ospf redistribute	205
Figure 5-15 ospf cost	211
Figure 5-16 ospf authentication	215
Figure 5-17 pbr	230
Figure 5-18 pbr	231
Figure 5-19 EBGp	235
Figure 5-20 IBGP	238
Figure 5-21 RIPng	242
Figure 6-1 Pim sm	256
Figure 6-2 bsr.....	262
Figure 6-3 Pim dm.....	266

Figure 6-4 mvr	278
Figure 7-1 Port Security	282
Figure 7-2 acl.....	288
Figure 7-3 extern acl.....	291
Figure 7-4 ipv6 acl	294
Figure 7-5 copp_acl	299
Figure 7-6 dot1x.....	302
Figure 7-7 Select "Setting-> System".....	306
Figure 7-8 Configure the shared-key, authorization port and account port.....	307
Figure 7-9 Add user name and password on the server.....	307
Figure 7-10 Guest vlan: before authenticated.....	309
Figure 7-11 Guest vlan: after authenticated.....	310
Figure 7-12 arp inspection.....	317
Figure 7-13 dhcp snooping.....	320
Figure 7-14 ip source guard.....	324
Figure 7-15 private vlan.....	326
Figure 7-16 private vlan.....	329
Figure 7-17 Telnet connecting test	330
Figure 7-18 Set IP address for PC.....	331
Figure 7-19 Connectivity test.....	332
Figure 7-20 WinRadius.....	332
Figure 7-21 WinRadius.....	332
Figure 7-22 Add user and password	333
Figure 7-23 Connectivity test.....	333
Figure 7-24 TACACS+	334
Figure 7-25 Telnet connecting test	336
Figure 7-26 Connectivity test.....	336
Figure 7-27 Port Isolate.....	337
Figure 7-28 Topology for DDoS test.....	340
Figure 8-1 syslog server	350
Figure 8-2 syslog on server.....	352

Figure 8-3 Mirror	353
Figure 8-4 port Mirror	357
Figure 8-5 Multi-destination Mirror	360
Figure 8-6 Remote Mirror	362
Figure 8-7 Mirror to cpu	365
Figure 8-8 smart config	380
Figure 9-1 NTP	387
Figure 9-2 external phy topology	392
Figure 9-3 Internal phy topology	392
Figure 9-4 Port level topology	393
Figure 9-5 ping a switch port	395
Figure 9-6 rmon	397
Figure 9-7 snmp	400
Figure 9-8 sflow	405
Figure 9-9 lldp	408
Figure 9-10 PTP Timing Domain	414
Figure 11-1 IPv6 over IPv4 Tunnel	445
Figure 11-2 IPv6 over IPv4 Tunnel	448
Figure 11-3 ISATAP Tunnel	449
Figure 11-4 Manual Tunnel	449
Figure 11-5 6to4 tunnel	453
Figure 11-6 6to4 relay	456
Figure 11-7 ISATAP tunnel	460
Figure 11-8 NDP	464
Figure 11-9 DHCP Relay	466
Figure 12-1 DHCPv6 Snooping	469
Figure 13-1 ipv6 unicast routing	473
Figure 13-2 OSPFv3	477
Figure 13-3 OSPFv3 priority	479
Figure 13-4 OSPFv3 area	483
Figure 13-5 OSPFv3 Redistribute	489

Figure 13-6 OSPFv3 Cost	495
Figure 13-7 RIPng	505
Figure 13-8 RIPng Metric.....	509
Figure 13-9 RIPng Distance.....	511
Figure 13-10 RIPng redistribute	513
Figure 13-11 RIPng Split-horizon	516
Figure 13-12 RIPng Route Distribute Filters	520
Figure 14-1 PIMv6 Sparse-mode.....	535
Figure 14-2 BSR	541
Figure 14-3 PIMv6 dense-mode.....	546
Figure 14-4 MVR6	558
Figure 15-1 IPv4 gre over IPv4	563
Figure 15-2 IPv4 gre Tunnel	564
Figure 16-1 EFM.....	570
Figure 16-2 EFM.....	572
Figure 16-3 EFM.....	574
Figure 16-4 EFM.....	576
Figure 16-5 CFM.....	579
Figure 16-6 CFM.....	588
Figure 16-7 CFM CSF	589
Figure 16-8 CFM.....	592
Figure 16-9 CFM.....	595
Figure 16-10 CFM.....	596
Figure 16-11 G.8031	606
Figure 16-12 Topology of single G8032 ring.....	610
Figure 16-13 Topology of multiple G8032 rings.....	610
Figure 16-14 UDLD	632
Figure 16-15 ERPS	635
Figure 16-16 ERPS	639
Figure 16-17 Smart-Link Typical Topology.....	646
Figure 16-18 Multi-Link Typical Topology.....	651

Figure 16-19 Multilink-enhance Typical Topology.....	655
Figure 16-20 monitor link	660
Figure 16-21 Without VRRP	663
Figure 16-22 With VRRP	664
Figure 16-23 VRRP with one virtual router	665
Figure 16-24 VRRP with two virtual router.....	667
Figure 16-25 VRRP Circuit Failover	670
Figure 16-26 IPv6 VRRP with one virtual router	674
Figure 16-27 IPv6 VRRP with two virtual router	676
Figure 16-28 IPv6 VRRP Circuit Failover.....	679
Figure 16-29 IP SLA	685
Figure 16-30 IP SLA	688
Figure 16-31 IP SLA	690
Figure 16-32 Track interface	692
Figure 16-33 Track ip sla	694
Figure 16-34 Track ip sla	695
Figure 16-35 Track bfd	697
Figure 16-36 VRRP Track.....	699
Figure 16-37 Static Route Track	701
Figure 16-38 BFD single hop.....	704
Figure 16-39 BFD multi hop.....	708
Figure 16-40 VARP with MALG	711
Figure 16-41 UDP-Helper configuration.....	713
Figure 17-1 Vxlan	715
Figure 17-2 Vxlan	718
Figure 17-3 EBGp_EVPN	722
Figure 17-4 IBGP_EVPN	728
Figure 17-5 NVGRE	736
Figure 17-6 NVGRE	739
Figure 17-7 GENEVE	743
Figure 17-8 GENEVE	746

Figure 17-9 Overlay multiple source ip.....	751
Figure 17-10 OVERLAY without Horizon Split.....	755
Figure 17-11 OVSDB	759
Figure 17-12 OVSDB	761
Figure 18-1 Priority-based Flow Control	765
Figure 18-2 EFD	768
Figure 19-1 LSP map.....	772
Figure 19-2 MPLS LSP model.....	775
Figure 19-3 VPLS model	778
Figure 19-4 Topology of vpws configuration	794
Figure 19-5 Uniform model	801
Figure 19-6 Pipe model	801
Figure 19-7 Short pipe model	802
Figure 19-8 MPLS QoS LSP model.....	802
Figure 19-9 L3VPN mode.....	811
Figure 19-10 MPLS LSP Topo.....	817
Figure 19-11 MPLS LSP Topo.....	821
Figure 20-1 PoE.....	837

1 Preface

1.1 Declaration

This document updates at irregular intervals because of product upgrade or other reason.

This document is for your reference only.

1.2 Suggestion feedback

If you have any questions when using our product and reading this document, please contact us

1.3 Audience

This document is for the following audiences:

- System maintenance engineers
- Debugging and testing engineers
- Network monitoring engineers
- Field maintenance engineers

2 Basic Configuration Guide

2.1 Configuring System Management

2.1.1 Overview

Function Introduction

Banner function is used for configuring messages on the devices. User can specify any messages to notify other users. Improper operations might cause critical situation such as service interrupt, in this case, a notification in advance is necessary. (E.g. to notify users "Don't reboot")

Three types of messages are supported by now:

- MOTD(message-of-the-day). Messages will display on the terminal when user connect to the device.
- login banner. Messages will display on the terminal when user login to the device. "Login mode" is required for displaying this message. Please reference the section of "Configuring User Management".
- exec banner. Messages will display on the terminal when user enter the EXEC mode.

Principle Description

This function displays notification on the terminal to reduce misoperation.

2.1.2 Configuration

Configuring a MOTD Login Banner

step 1 Enter the configure mode

```
Switch# configure terminal
```

step 2 Create the notification

User can create a notification (one line or multiple lines) to display on all connected terminals. In the following example, the delimiting character is #. All characters between two delimiting characters will display on the terminals when user connect the device.

The message length is at most 99 lines with 1023 character in each line.

```
Switch(config)# banner motd # This is a switch #
```

step 3 Exit the configure mode

```
Switch(config)# exit
```

step 4 Validation

Use the following command to display the configuration:

```
switch# show running
banner motd ^C
  This is a switch
^C
```

Configuring a Login Banner

step 1 Enter the configure mode

```
Switch# configure terminal
```

step 2 Create the notification

User can create a notification (one line or multiple lines) to display on all connected terminals. "Login mode" is required for displaying this message. Please reference the section of "Configuring User Management".

In the following example, the delimiting character is #. All characters between two delimiting characters will display on the terminals when user connect the device.

The message length is at most 99 lines with 1023 character in each line.

```
Switch(config)# banner login # admin login #
```

step 3 Exit the configure mode

```
Switch(config)# exit
```

step 4 Validation

Use the following command to display the configuration

```
switch# show running
banner login ^C
  admin login
^C
```

Configuring an Exec Banner

step 1 Enter the configure mode

```
Switch# configure terminal
```

step 2 Create the notification

User can create a notification (one line or multiple lines) to display on all connected terminals. In the following example, the delimiting character is #. All characters between two delimiting characters will display on the terminals when user enter the EXEC mode.

The message length is at most 99 lines with 1023 character in each line.

```
Switch(config)# banner exec # do not reboot! #
```

step 3 Exit the configure mode

```
Switch(config)# exit
```

step 4 Validation

Use the following command to display the configuration:

```
switch# show running
banner exec ^C
  do not reboot!
^C
```

2.1.3 Application cases

Case 1: mark the usage of the device

Set the MOTD message as "This is a switch of some area/department", user can see this message when connect to the device. If the user needs to operate a switch of another department, he can realize that he connected to a wrong device and stop misoperation.

Configuration steps

```
Switch# configure terminal
Switch(config)# banner motd # This is a switch of IT DEPARTMENT !!! #
Switch(config)# exit
```

Configuration files

```
switch# show running
banner motd ^C
  This is a switch of IT DEPARTMENT !!!
^C
```

2.2 Configuring User Management

2.2.1 Overview

Function Introduction

User management increases the security of the system by keeping the unauthorized users from guessing the password. The user is limited to a specific number of attempts to successfully log in to the switch.

There are three load modes in the switch.

- In “no login” mode, anyone can load the switch without authentication.
- In “login” mode, there is only one default user.
- In “login local” mode, if you want to load the switch you need to have a user account. Local user authentication uses local user accounts and passwords that you create to validate the login attempts of local users. Each switch has a maximum of 32 local user accounts. Before you can enable local user

authentication, you must define at least one local user account. You can set up local user accounts by creating a unique username and password combination for each local user. Each username must be fewer than 32 characters. You can configure each local user account with a privilege level; the valid privilege levels are 1 or 4. Once a local user is logged in, only the commands those are available for that privilege level can be displayed.

There is only one user can enter the configure mode at the same time.

Principle Description

N/A

2.2.2 Configuration

Configuring the user management in login local mode

step 1 Enter the configure mode

```
Switch# configure terminal
```

step 2 et username and password

```
Switch(config)# username testname privilege 4 password 123abc<>
```

step 3 Enter the configure mode and set user management mode

```
Switch(config)# line vty 0 7  
Switch(config-line)# login local  
Switch(config-line)# exit
```

step 4 Exit the configure mode

```
Switch(config)# exit
```

step 5 Validation

After the above setting, login the switch will need a username and password, and user can login with the username and password created before. This is a sample output of the login prompt.

```
Username:
```

After the input the username, a password is required.

```
Username: testname
Password:
```

Authentication succeed:

```
Password:
Switch#
```

Configuring the user management in login mode

step 1 Enter the configure mode

```
Switch# configure terminal
```

step 2 Enter the configure mode and set password

```
Switch(config)# line vty 0 7
Switch(config-line)# line-password abc
Switch(config-line)# login
```

step 3 Exit the configure mode

```
Switch(config)# exit
```

step 4 Validation

After the above setting, login the switch will need the line password, and user can login with the password created before. This is a sample output of the login prompt.

```
Password:
```

Configuring Password recovery procedure

If the password is forgotten unfortunately, it can be recovered by following steps.

Step 1 Power on the system. Boot loader will start to run. The follow information will be printed on Console.

```
CPU:   MPC8247 (HiP7 Rev 14, Mask 1.0 1K50M) at 350 MHz
Board: 8247 (PCI Agent Mode)
I2C:   ready
DRAM:  256 MB
In:    serial
Out:   serial
```

```
Err:   serial
Net:   FCC1 ETHERNET, FCC2 ETHERNET [PRIME]
Press ctrl+b to stop autoboot: 3
```

Step 2 Press ctrl+b. stop autoboot.

```
Bootrom#
```

Step 3 Under boot loader interface, use the following instructions.

```
Bootrom# boot_flash_nopass
Bootrom# Do you want to revert to the default config file ? [Y|N|E]:
```



Please remember your username and password.

Recovering the password may lead configuration lost or service interrupted; we strongly recommend that user should remember the username and password.

2.2.3 Application cases

N/A

2.3 Configuring FTP

2.3.1 Overview

Function Introduction

You can download a switch configuration file from an FTP server or upload the file from the switch to an FTP server. You download a switch configuration file from a server to upgrade the switch configuration. You can overwrite the current startup configuration file with the new one. You upload a switch configuration file to a server for backup purposes. You can use this uploaded configuration for future downloads to the switch or another switch of the same type.

Principle Description

N/A

2.3.2 Configuration

You can copy configurations files to or from an FTP server. The FTP protocol requires a client to send a remote username and password on each FTP request to a server.

Before you begin downloading or uploading a configuration file by using FTP, do these tasks:

- Ensure that the switch has a route to the FTP server. The switch and the FTP server must be in the same network if you do not have a router to route traffic between subnets. Check connectivity to the FTP server by using the ping command.
- If you are accessing the switch through the console or a Telnet session and you do not have a valid username, make sure that the current FTP username is the one that you want to use for the FTP download.
- When you upload a configuration file to the FTP server, it must be properly configured to accept the write request from the user on the switch.

For more information, see the documentation for your FTP server.

Downloading a configuration file by using FTP in IPv4 network

step 1 copy the configuration file

```
Switch# copy mgmt-if ftp://test:test@10.10.10.163/ startup-config.conf  
flash:/startup-config.conf
```

step 2 Validation

Use the following command to display the configuration

```
Switch# show startup-config
```

Uploading a configuration file by using FTP in IPv4 network

step 1 copy the configuration file

```
Switch# copy flash:/startup-config.conf mgmt-if  
ftp://test:test@10.10.10.163/startup-config.conf
```

Downloading a configuration file by using FTP in IPv6 network

Username and password settings are same as IPv4 network.

step 1 copy the configuration file

```
Switch# copy ftp://root:root@2001:1000::2/startup-config.conf flash:/startup-config.conf
```

Uploading a configuration file by using FTP in IPv6 network

Username and password settings are same as IPv4 network.

step 1 copy the configuration file

```
Switch# copy flash:/startup-config.conf mgmt-if ftp://root:root@2001:1000::2 startup-config.conf
```

2.3.3 Application cases

N/A

2.4 Configuring FTP SERVER

2.4.1 Overview

Function Introduction

You can download a switch configuration file from an FTP server or upload the file from the switch to an FTP server. You download a switch configuration file from a server to upgrade the switch configuration. You can overwrite the current startup configuration file with the new one. You upload a switch configuration file to a server for backup purposes. You can use this uploaded configuration for future downloads to the switch or another switch of the same type.

Principle Description

N/A

2.4.2 Configuration

You can copy configurations files to or from an FTP server. The FTP protocol requires a client to send a remote username and password on each FTP request to a server.

Before you begin downloading or uploading a configuration file by using FTP, do these tasks:

- Ensure that the switch has a route to the FTP server. The switch and the FTP server must be in the same network if you do not have a router to route traffic between subnets. Check connectivity to the FTP server by using the ping command.
- If you are accessing the switch through the console or a Telnet session and you do not have a valid username, make sure that the current FTP username is the one that you want to use for the FTP download.
- When you upload a configuration file to the FTP server, it must be properly configured to accept the write request from the user on the switch.

For more information, see the documentation for your FTP server.

configuration of FTP server

step 1 Enter the configure mode

```
Switch# configure terminal
```

step 2 Enable FTP server on management interface

```
Switch(config)# ftp server mgmt-if enable
```

step 3 Config switch system users

Users should config password and the privilege should be 4

```
Switch(config)# username admin privilege 4 password admin
```

step 4 Validation

Client connect to FTP server, enter the username and password. The IP address of server management interface is 10.10.10.10

```
Switch# ftp mgmt-if 10.10.10.10
Connected to 10.10.10.10.
220----- Welcome to FTP-SERVER -----
220-You are user number 1 of 50 allowed.
220-Local time is now 06:41. Server port: 21.
220-IPv6 connections are also welcome on this server.
220 You will be disconnected after 15 minutes of inactivity.
Name (10.10.10.10:LOGIN): admin
331 User admin OK. Password required
Password:
230 OK. Current directory is /
Remote system type is UNIX.
Using binary mode to transfer files.
```

Other optional configuration

Config FTP server port , default is 21

```
Switch# ftp server port 10000
```

Config FTP server time-out , default is 15min

```
Switch# ftp server time-out 5
```

Config FTP server VRF or IP address inband. config source IP is 1.1.1.1 , config source vrf is test , config source vrf is test and source IP is 2.2.2.2.

```
Switch# ftp server source address 1.1.1.1
Switch# ftp server source address vrf test 0.0.0.0
Switch# ftp server source address vrf test 2.2.2.2
```

2.4.3 Application cases

N/A

2.5 Configuring TFTP

2.5.1 Overview

Function Introduction

You can download a switch configuration file from a TFTP server or upload the file from the switch to a TFTP server. You download a switch configuration file from a server to upgrade the switch configuration. You can overwrite the current file with

the new one. You upload a switch configuration file to a server for backup purposes; this uploaded file can be used for future downloads to the same or another switch of the same type.

Principle Description

N/A

2.5.2 Configuration

Before you begin downloading or uploading a configuration file by using TFTP, do these tasks:

Ensure that the workstation acting as the TFTP server is properly configured.

Ensure that the switch has a route to the TFTP server. The switch and the TFTP server must be in the same network if you do not have a router to route traffic between subnets. Check connectivity to the TFTP server by using the ping command.

Ensure that the configuration to be downloaded is in the correct directory on the TFTP server.

For download operations, ensure that the permissions on the file are set correctly.

During upload operations, if you are overwriting an existing file (including an empty file, if you had to create one) on the server, ensure that the permissions on the file are set correctly.

Downloading a configuration file by using TFTP in IPv4 network

```
Switch# copy mgmt-if tftp://10.10.10.163/startup-config.conf flash:/startup-config.conf
```

Uploading a configuration file by using TFTP in IPv4 network

```
Switch# copy flash:/startup-config.conf mgmt-if tftp://10.10.10.163/startup-config.conf
```

Downloading a configuration file by using TFTP in IPv6 network

```
Switch# copy mgmt-if tftp://2001:1000::2/startup-config.conf flash:/startup-config.conf
```

Uploading a configuration file by using TFTP in IPv6 network

```
Switch# copy flash:/startup-config.conf mgmt-if tftp://2001:1000::2/startup-  
config.conf
```

2.5.3 Application cases

N/A

2.6 Configuring SCP

2.6.1 Overview

Function Introduction

SCP, which is short for secure copy, is a part of SSH protocol. It is a remote copy technology which is based on SSH protocol. User can download a switch configuration file from a SCP server or upload the file from the switch to a SCP server. User can download a switch configuration file from a server to upgrade the switch configuration and overwrite the current file with the new one. User can upload a switch configuration file to a server for backup purposes; this uploaded file can be used for future downloads to the same or another switch of the same type.

Principle Description

N/A

2.6.2 Configuration

Before you begin downloading or uploading a configuration file by using SCP, do these tasks:

Ensure that the workstation acting as the SCP server is properly configured.

Ensure that the switch has a route to the SCP server. The switch and the SCP server must be in the same network if you do not have a router to route traffic between subnets. Check connectivity to the SCP server by using the ping command.

Ensure that the configuration to be downloaded is in the correct directory on the SCP server.

For download operations, ensure that the permissions on the file are set correctly.

During upload operations, if you are overwriting an existing file (including an empty file, if you had to create one) on the server, ensure that the permissions on the file are set correctly.

Downloading a configuration file by using SCP in IPv4 network

```
Switch# copy mgmt-if scp://10.10.10.163/startup-config.conf flash:/startup-config.conf
```

Uploading a configuration file by using SCP in IPv4 network

```
Switch# copy flash:/startup-config.conf mgmt-if scp://10.10.10.163/startup-config.conf
```

Downloading a configuration file by using SCP in IPv6 network

```
Switch# copy mgmt-if scp://2001:1000::2/startup-config.conf flash:/startup-config.conf
```

Uploading a configuration file by using SCP in IPv6 network

```
Switch# copy flash:/startup-config.conf mgmt-if scp://2001:1000::2/startup-config.conf
```

2.6.3 Application cases

N/A

2.7 Configuring Telnet

2.7.1 Overview

Function Introduction

Telnet is a network protocol used on the Internet or local area networks to provide a bidirectional interactive text-oriented communications facility using a virtual terminal connection. User data is interspersed in-band with Telnet control information in an 8-bit byte oriented data connection over the Transmission Control Protocol (TCP). Telnet was developed in 1969 beginning with RFC 15, extended in RFC 854, and standardized as Internet Engineering Task Force (IETF) Internet

Standard STD 8, one of the first Internet standards. Historically, Telnet provided access to a command-line interface (usually, of an operating system) on a remote host. Most network equipment and operating systems with a TCP/IP stack support a Telnet service for remote configuration (including systems based on Windows NT). Because of security issues with Telnet, its use for this purpose has waned in favor of SSH.

Principle Description

N/A

2.7.2 Configuration

Telnet switch with inner port

Example 1 IPv4 Network

```
Switch# telnet 10.10.29.247
Entering character mode
Escape character is '^]'.
Switch #
```

Example 2 IPv6 Network

```
Switch# telnet 2001:1000::71
Entering character mode
Escape character is '^]'.
Switch #
```

Telnet switch with management port

Example 1 IPv4 Network

```
Switch# telnet mgmt-if 10.10.29.247
Entering character mode
Escape character is '^]'.
Switch #
```

Example 2 IPv6 Network

```
Switch# telnet mgmt-if 2001:1000::2
Entering character mode
```

```
Escape character is '^]'.  
Switch #
```

Configure telnet server

step 1 Enter the configure mode

```
Switch# configure terminal
```

step 2 Enable Telnet service

```
Switch(config)# service telnet enable
```

step 3 Exit the configure mode

```
Switch(config)# exit
```

2.7.3 Application cases

N/A

2.8 Configuring SSH

2.8.1 Overview

Function Introduction

The Secure Shell (SSH) is a protocol that provides a secure, remote connection to a device. SSH provides more security for remote connections than Telnet does by providing strong encryption when a device is authenticated. SSH supports the Data Encryption Standard (DES) encryption algorithm, the Triple DES (3DES) encryption algorithm, and password-based user authentication. The SSH feature has an SSH server and an SSH integrated client, which are applications that run on the switch. You can use an SSH client to connect to a switch running the SSH server. The SSH server works with the SSH client supported in this release and with SSH clients. The SSH client also works with the SSH server supported in this release and with SSH servers.

Principle Description

N/A

2.8.2 Configuration



Figure 2-1 SSH system application

Create key for SSH

step 1 Enter the configure mode

```
Switch# configure terminal
```

step 2 Create a key

```
Switch(config)# rsa key a generate
```

step 3 Create a private key named a.pri with key a and save it to flash

```
Switch(config)# rsa key a export url flash:/a.pri private ssh2
```

step 4 Create a private key named a.pub with key a and save it to flash

```
Switch(config)# rsa key a export url flash:/a.pub public ssh2
```

step 5 Exit the configure mode

```
Switch(config)# exit
```

Import the key

step 1 Enter the configure mode

```
Switch# configure terminal
```

step 2 Import the key a.pub we created as importKey

```
Switch(config)# rsa key importKey import url flash:/a.pub public ssh2
```

step 3 Create username and password

```
Switch(config)# username aaa privilege 4 password abc
```

step 4 Assign the key to user aaa

```
Switch(config)# username aaa assign rsa key importKey
```

step 5 Exit the configure mode

```
Switch(config)# exit
```

Use SSH to connect

step 1 Download the a.pri key on SSH client

step 2 Connect to the client

```
[root@test1 tftpbboot]# ssh -i a.pri aaa@10.10.39.101  
aaa@10.10.39.101's password:  
Switch#
```

2.8.3 Application cases

N/A

2.9 Configuring Time&timezone

2.9.1 Overview

Function Introduction

If no other source of time is available, you can manually configure the time and date after the system is restarted. The time remains accurate until the next system restart. We recommend that you use manual configuration only as a last resort. If you have an outside source to which the switch can synchronize, you do not need to manually set the system clock.

Principle Description

N/A

2.9.2 Configuration

step 1 Enter the configure mode

```
Switch# configure terminal
```

step 2 Configuring time and timezone

```
Switch(config)# clock set datetime 11:30:00 10 26 2013
Switch(config)# clock set summer-time dst date 6 1 2013 02:00:00 10 31 2013
02:00:00 120
```

step 3 Exit the configure mode

```
Switch(config)# exit
```

step 4 Validation

Use the following command to display the information of time and date:

```
Switch# show clock detail
13:31:10 dst Sat Oct 26 2013
Time zone: (GMT + 08:00:00) beijing
Summer time starts at beijing 02:00:00 06/01/2013
Summer time ends at dst 02:00:00 10/31/2013
Summer time offset: 120 minutes
```

2.9.3 Application cases

N/A

2.10 Configuring License

2.10.1 Overview

Function Introduction

License will control the features on the switch; each switch has its own license to avoid the unauthorized user to use the advanced features. There are totally three kinds of licenses: Enterprise Base, Metro Service, and Metro Advanced. Different license will contain different features. Customer can apply different license to satisfy different requirement. If switch has no license, it can only provide L2 features. Different switch can't share the same license. In order to get the license for the specify switch, first generate the unique device identifier(UDI) for the switch and then send the UDI to vendor to apply the license, at last get the license from vendor and use the license on the switch.

Principle Description

N/A

2.10.2 Configuration

step 1 Create UDI for the device and send it to remote FTP server

```
Switch# generate device identifier mgmt-if ftp://test:test@10.10.25.33/device.udi
```

step 2 Apply license

Send UDI file to vendor, vendor will generate license for customer requirement.

step 3 Use license

Get the license to local from remote FTP server, and reload the system.

```
Switch# copy mgmt-if ftp://test:test@10.10.25.33/device.lic flash:/device.lic  
Switch# reload
```



NOTE

You must reload the switch for the license to take effect.

If the switch has no license, it can only work with L2 features.

If the switch has more than one license, all the features contain by the licenses can take effect

step 4 Validation

Use the following command to display the information of the license:

```
Switch# show license
License files:
=====
flash:/ma.lic:
  Created Time: Fri Dec  6 17:22:23 CST 2013
  Vendor:      switchVendor
  Customer:    switchCustomer
  Device MAC:  00:1E:08:09:03:00
  Feature Set: QINQ MVR ERPS MEF ETHOAM
              VPWS VPLS HVPLS SMLK TPOAM
              OSPF PIM_SM IGMP VRF MPLS
              LDP BGP RSVP OSPF_TE EXTEND_ACL
              PTP BFD SSM IPV6 OSPF6
              PIM_SM6 MVR6 RIPNG TUNNEL_V6
```

2.11 RPC API Configuration Guide

2.11.1 Overview

Function Introduction

RPC API service allows user to configure and monitor the switch system through Remote Procedure Calls (RPC) from your program.

The service currently supports JSON-RPC over HTTP protocol together with HTTP Basic authentication.

Principle Description

RPC API service uses standard JSON-RPC over HTTP protocol to communicate the switch and your program. User may issue switch CLI commands through JSON-RPC method: 'executeCmds'. By default, the CLI mode is in privileged EXEC mode (#).

User could send JSON-RPC request via an HTTP POST request to URL: http://:/command-api. The detailed JSON-RPC request and response are show below:

JSON-RPC Request

```

{
  "params":[
    {
      "format":"text",
      "version":1,
      "cmds":[
        "show run",
        "config t",
        "vlan database",
        "vlan 1-8",
        "interface eth-0-1",
        "switchport mode trunk",
        "switchport trunk allowed vlan add 2",
        "shutdown",
        "end",
        "show interface switchport"
      ]
    }
  ],
  "jsonrpc":"2.0",
  "method":"executeCmds",
  "id":"70853aff-af77-420e-8f3c-fa9430733a19"
}

```

Parameters for command

Expected response format, can be 'text' or 'json', the default format is 'text'

The API version

List of CLI commands

CLI command 1

CLI command 2

CLI command 3

CLI command 4

CLI command 5

CLI command 6

CLI command 7

CLI command 8

CLI command 9

CLI command 10

JSON RPC protocol version. Always 2.0.

Method to run the switch CLI commands

JSON RPC unique identifier

JSON-RPC Response

```

{
  "jsonrpc":"2.0",
  "id":"70853aff-af77-420e-8f3c-fa9430733a19",
  "result":[
    {
      "sourceDetails":"version 5.1.6.fcs\n!\n ..",
      "errorCode":-1003,
      "errorDesc":"unsupported command..",
      "warnings":"% Invalid..",
    }
  ]
}

```

JSON RPC protocol version. Always 2.0.

JSON RPC unique identifier

Result list of objects from each CLI command executed.

Output information of CLI Command 1.

The Original ASCII output information returned from CLI command if this command is successfully executed.

Error code if it is available.

Error description if it is available.

Warnings if it is available.

Formatted JSON object will also be returned if it is available.

Output information of CLI Command 2.

```

        { },                               Output information of CLI
Command 3.
        { },                               Output information of CLI
Command 4.
        { },                               Output information of CLI
Command 5.
        { },                               Output information of CLI
Command 6.
        { },                               Output information of CLI
Command 7.
        { },                               Output information of CLI
Command 8.
        { },                               Output information of CLI
Command 9.
        {
            "sourceDetails":" Interface name      : eth-0-1\n Switchport
mode          : trunk\n ...\n"
        }                                   Output information of CLI
Command 10.
    ]
}

```

Python Client Example Code

Here is an example code using 'pyjsonrpc' library:

```

import pyjsonrpc
import json

http_client = pyjsonrpc.HttpClient(
    url = "http://10.10.39.64:80/command-api",
    username = "username",
    password = "password"
)

cmds = {}
cmd_list = ["show run", "config t", "vlan database", "vlan 1-8", "interface eth-0-1", "switchport mode trunk", "switchport trunk allowed vlan add 2", "shutdown", "end", "show interface switchport"]

cmds['cmds'] = cmd_list
cmds['format'] = 'text'
cmds['version'] = 1

try:
    response = http_client.call("executeCmds", cmds)
    print("json response:");
    json_result = json.dumps(response, indent=4)
    print(json_result)
except Exception, e:
    if e.code == 401:
        print "Unauthorized user"
    else:

```

```
print e.message
print e.data
```

Error code

Here is a list of JSON-RPC 2.0 error code:

Error Code	Description
-32700	Parse error
-32600	Invalid Request
-32601	Method not found
-32602	Invalid param
-32603	Internal error

Here is a list of RPC-API error code:

Error Code	Description
-1000	General error
-2001	JSON RPC API Error: unsupported API version
-2002	JSON RPC API Error: must specify 'params' with 'cmds' in JSON RPC
-2003	JSON RPC API Error: unsupported command response format
-3001	Command execution failed: timed out
-3002	Command execution failed: unsupported command
-3003	Command execution failed: unauthorized command
-3004	Command execution failed: the string does not match any command in current mode

-3005	Command execution failed: can't convert to JSON format
-3006	Command execution failed: command list too short
-3007	Command execution failed: command list too long

2.11.2 Configuration

Configuring RPC API service

User could enable the RPC API service by the following steps.

The default port is 80.

step 1 Enter the configure mode

```
Switch# configure terminal
```

step 2 Enable RPC API service

```
Switch(config)# service rpc-api enable
```



NOTE

Use the following command to disable rpc-api service:

```
Switch(config)# service rpc-api disable
```

step 3 Exit the configure mode

```
Switch(config)# end
```

Configuring RPC API service with HTTP Authentication

User could configure the HTTP authentication mode of RPC API service.

Currently, only HTTP Basic authentication is supported. User will receive status code: 401 (Unauthorized access) if user provides invalid user name or password.

step 1 Enter the configure mode

```
Switch# configure terminal
```

Step 2 Set the username and password, then enable the rpc-api authentication

```
Switch(config)# username myuser password mypass privilege 4  
Switch(config)# service rpc-api auth-mode basic
```



NOTE

Use the following command to disable authentication:

```
Switch(config)# no service rpc-api auth-mode
```



NOTE

HTTP authentication settings of RPC API service will take effect after you restart this service or reboot the system.

step 3 Exit the configure mode

```
Switch(config)# end
```

step 4 Validation

```
Switch# show services rpc-api  
RPC API service configuration:  
Server State      : enable  
Port              : 80  
Authentication Mode : basic  
VRF               : default
```

2.11.3 Application cases

N/A

2.12 Configuring HTTP

2.12.1 Overview

Function Introduction

This chapter describes how to configure the switch to start the Web management function.

Principle Description

N/A

2.12.2 Configuration

Preparatory

Put a valid web image to flash: directory. Please reference to FTP or TFTP guide.

Configure HTTP server

step 1 Enter the configure mode

```
Switch# configure terminal
```

step 2 Load WEB image

```
Switch(config)# http server load flash:/webImage.bin
```

step 3 Configure HTTP server address (Optional)

Use this step to specify the source address of WEB http server, only loopback address is supported. If the source address of WEB http server is specified, it will be the only address to access the WEB. If the source address of WEB http server is not specified, user can access the WEB via the same address as telnet. The route between the device and the client is necessary.

```
Switch(config)# interface loopback 0
Switch(config-if)# ip address 192.168.1.100/32
Switch(config-if)# quit
Switch(config)# http server source address 192.168.1.100
This operation will cause all the online HTTP(S) users to be offline.
Continue? [yes/no]: yes
Switch(config)# ip route 0.0.0.0/0 192.168.1.1
```

step 4 Enable HTTP service

```
Switch(config)# service http enable
This operation will cause all the online HTTP(S) users to be offline.
Continue? [yes/no]: yes
```

step 5 Exit the configure mode

```
Switch(config)# exit
```

step 6 Login the web via the browser

Enter the IP address to login the web.

2.12.3 Application cases

N/A

3 Ethernet Configuration Guide

3.1 Configuring Interface

3.1.1 Overview

Function Introduction

Interface status, speed and duplex are configurable.

When the interface is configured as "no shutdown", it can work normally after cable is connected. When the interface is configured as "shutdown", no matter the cable is connected or not, the interface can not work.

If the device supports combo ports, user can choose to enable copper or fiber mode. The two modes of one port can not work together at same time. The configuration of speed or duplex at combo ports cannot be effective when combo port is working at fiber mode.

The rule of physical port name is as following: interface name format is eth-[slot]-[port]; [slot] is 0 for single pizza-box switch; when stacking is enabled, the [slot] number is according to the configuration. The [port] number is begin with 1, and increase from up to down, from left to right. The following figure shows the interface name of the device:

eth-0-1	eth-0-3	...	eth-0-23
eth-0-2	eth-0-4	...	eth-0-24

Figure 3-1 Interface Name



NOTE

To get more information about the interface type and number, please reference to the product spec.

Principle Description

N/A

3.1.2 Configuration

Configuring Interface State

step 1 Enter the configure mode

```
Switch# configure terminal
```

step 2 Turn on an interface

```
Switch#(config)# interface eth-0-1  
Switch(config-if)# no shutdown
```

step 3 Shut down an interface

```
Switch(config-if)# interface eth-0-2  
Switch(config-if)# shutdown
```

step 4 Exit the configure mode

```
Switch(config-if)# end
```

step 5 Validation

Use the following command to display the status of the interfaces:

```
Switch# show interface status
```

Port	Status	Duplex	Speed	Mode	Type
eth-0-1	up	a-full	a-1000	access	1000BASE_T
eth-0-2	admin down	auto	auto	access	1000BASE_T

Configuring Interface Speed

step 1 Enter the configure mode

```
Switch# configure terminal
```

step 2 Enter the interface configure mode and set the speed

Set speed of interface eth-0-1 to 100M

```
Switch(config)# interface eth-0-1
Switch(config-if)# speed 100
Switch(config-if)# no shutdown
```

Set speed of interface eth-0-2 to 1000M

```
Switch(config-if)# interface eth-0-2
Switch(config-if)# no shutdown
Switch(config-if)# speed 1000
```

Set speed of interface eth-0-3 to auto

```
Switch(config-if)# interface eth-0-3
Switch(config-if)# no shutdown
Switch(config-if)# speed auto
```

step 3 Exit the configure mode

```
Switch(config-if)# end
```

step 4 Validation

Use the following command to display the status of the interfaces:

```
Switch# show interface status
Port      Status    Duplex   Speed   Mode    Type
-----
eth-0-1   up        a-full   100     access  1000BASE_T
eth-0-2   up        a-full   1000    access  1000BASE_T
eth-0-3   up        a-full   a-1000  access  1000BASE_T
```

Configuring Interface Duplex

There are 3 duplex mode supported on the device:

- full mode: the interface can transmit and receive packets at same time.
- half mode: the interface can transmit or receive packets at same time.
- auto mode: the interface should negotiate with the other side to decide the duplex mode.

User can choose proper duplex mode according to the network state.

step 1 Enter the configure mode

```
Switch# configure terminal
```

step 2 Enter the interface configure mode and set the duplex

Set duplex of interface eth-0-1 to full

```
Switch(config)# interface eth-0-1
Switch(config-if)# no shutdown
Switch(config-if)# duplex full
```

Set duplex of interface eth-0-1 to half

```
Switch(config-if)# interface eth-0-2
Switch(config-if)# no shutdown
Switch(config-if)# duplex half
```

Set duplex of interface eth-0-1 to auto

```
Switch(config)# interface eth-0-3
Switch(config-if)# no shutdown
Switch(config-if)# duplex auto
```

step 4 Validation

Use the following command to display the status of the interfaces:

```
Switch# show interface status
Port      Status   Duplex   Speed   Mode   Type
-----
eth-0-1   up       full     a-1000  access 1000BASE_T
eth-0-2   up       half     a-100   access 1000BASE_T
eth-0-3   up       a-full   a-1000  access 1000BASE_T
```

3.1.3 Application cases

N/A

3.2 Configuring Group-speed of Interfaces

3.2.1 Overview

Function Introduction

The interfaces in the same group shares the same speed, which is called “group-speed”; Use the "group-speed" command in any interface will affect all other members in this group.

Principle Description

N/A

3.2.2 Configuration

View group ID info of interface

Before interface speed is set, users need know which interfaces belong to interface-group and which interfaces are in the same interface-group; the interfaces not in interface-group use speed command to set speed mode, and the interfaces in interface-group use group-speed command to set speed mode.

if group-id of interface is 0, it's means that the interface doesn't belong to interface-group, otherwise the interface belongs to interface-group; and the same group-id interfaces belong to the same interface-group.

step 1 show group ID info of interfaces

Use the following command to display the interface-group info of the interfaces:

```
Switch# show group-id info
Group Id    Member Ports
-----+-----
0          eth-0-1    eth-0-2
           eth-0-3    eth-0-4
           eth-0-5    eth-0-6
           eth-0-7    eth-0-8
           eth-0-9    eth-0-10
           eth-0-11  eth-0-12
           eth-0-13  eth-0-14
```

```

eth-0-15 eth-0-16
eth-0-17 eth-0-18
eth-0-19 eth-0-20
eth-0-21 eth-0-22
eth-0-23 eth-0-24
eth-0-25 eth-0-26
eth-0-27 eth-0-28
eth-0-29 eth-0-30
eth-0-31 eth-0-32
eth-0-33 eth-0-34
eth-0-35 eth-0-36
eth-0-37 eth-0-38
eth-0-39 eth-0-40
eth-0-41 eth-0-42
eth-0-43 eth-0-44
eth-0-45 eth-0-46
eth-0-47 eth-0-48
-----
1      eth-0-49 eth-0-50
      eth-0-51 eth-0-52
Switch#

```

step 2 Set the group speed

```

Switch# configure terminal
Switch(config)# interface eth-0-49
Switch(config-if)# group-speed 1000
% Warning: Speed of Port eth-0-49, eth-0-50, eth-0-51, eth-0-52 will all be
switched to 1000M after entering this CLI

```

3.2.3 Application cases

N/A

3.3 Configuring Layer3 Interfaces

3.3.1 Overview

Function Introduction

3 types of Layer3 interface are supported:

- VLAN interfaces: Logical interface with layer3 features. Connect different VLANs via IP address on the VLAN interface. VLAN interfaces can be created and deleted.

- **Routed Ports:** Ports are physical ports configured to be in Layer 3 mode by using the `no switchport` in interface configuration command.
- **Layer 3 Link Aggregation Ports:** Link Aggregation interfaces made up of routed ports.

A Layer 3 switch can have an IP address assigned to each routed port and VLAN interface. All Layer 3 interfaces require an IP address to route traffic. This section shows how to configure an interface as a Layer 3 interface and how to assign an IP address to an interface.

Principle Description

N/A

3.3.2 Configuration

Configuring Routed Port

step 1 Enter the configure mode

```
Switch# configure terminal
```

step 2 Enter the interface configure mode and set IP address

```
Switch(config)# interface eth-0-1
Switch(config-if)# no switchport
Switch(config-if)# no shutdown
Switch(config-if)# ip address 1.1.1.1/24
```

step 3 Exit the configure mode

```
Switch(config-if)# end
```

step 4 Validation

Use the following command to display the brief status of the interfaces:

```
Switch# show ip interface brief
Interface          IP-Address      Status          Protocol
eth-0-1            1.1.1.1         up              up
Switch# show ip interface
Interface eth-0-1
  Interface current state: UP
```

```
Internet address(es):
  1.1.1.1/24 broadcast 1.1.1.255
Joined group address(es):
  224.0.0.1
The maximum transmit unit is 1500 bytes
ICMP error messages limited to one every 1000 milliseconds
ICMP redirects are always sent
ICMP unreachable are always sent
ICMP mask replies are always sent
ARP timeout 01:00:00, ARP retry interval 1s
VRRP master of: VRRP is not configured on this interface
```

Configuring VLAN Interfaces

This chapter describes configuring VLAN interfaces and using them. Several Virtual LAN (VLAN) interfaces can be configured on a single Ethernet interface. Once created, a VLAN interface functions the same as any physical interface, and it can be configured and displayed like any physical interface. Routing protocols, such as, RIP, OSPF and BGP can run across networks using VLAN interfaces.

step 1 Enter the configure mode

```
Switch# configure terminal
```

step 2 Enter the vlan configure mode and create a vlan

```
Switch(config)# vlan database
Switch(config-vlan)# vlan 10
Switch(config-vlan)# exit
```

step 3 Enter the interface configure mode and set switch port attributes

```
Switch(config)# interface eth-0-2
Switch(config-if)# switchport mode trunk
Switch(config-if)# switchport trunk allowed vlan all
Switch(config-if)# no shutdown
Switch(config-if)# exit
```

step 4 Enter the vlan interface configure mode and set IP address

```
Switch(config)# interface vlan10
Switch(config-if)# ip address 2.2.2.2/24
```

step 5 Exit the configure mode

```
Switch(config-if)# end
```

step 6 Validation

Use the following command to display the brief status of the interfaces:

```
Switch# show ip interface brief
Interface          IP-Address      Status          Protocol
vlan10            2.2.2.2         up              up

Switch# show ip interface
Interface vlan10
  Interface current state: UP
  Internet address(es):
    2.2.2.2/24 broadcast 2.2.2.255
  Joined group address(es):
    224.0.0.1
  The maximum transmit unit is 1500 bytes
  ICMP error messages limited to one every 1000 milliseconds
  ICMP redirects are always sent
  ICMP redirects are always sent
  ICMP unreachable are always sent
  ICMP mask replies are always sent
  ARP timeout 01:00:00, ARP retry interval 1s
  VRRP master of : VRRP is not configured on this interface
```

3.4 Configuring Interface Errdisable

3.4.1 Overview

Function Introduction

Errdisable is a mechanism to protect the system through shutdown the abnormal interface. If an interface enters errdisable state, there are two ways to recovery it from errdisabled state. The first one is to enable errdisable recovery of this reason before errdisable detection; the interface will be recovered automatically after the configured time. But if errdisable occurred first, then errdisable recovery is enabled, the errdisable will not be recovered automatically. The secondary one is configuring “no shutdown” command on the errdisabled interface.

The flap of interface link state is a potential error caused by hardware or line problem. The administrator can also configure the detection conditions of interface link flap to suppress the flap.

Principle Description

N/A

3.4.2 Configuration

Configuring Errdisable Detection

step 1 Enter the configure mode

```
Switch# configure terminal
```

step 2 Enable detect link flap errdisable

```
Switch(config)# errdisable detect reason link-flap
```

step 3 Exit the configure mode

```
Switch(config)# end
```

step 4 Validation

Use the following command to display the configuration of error disable:

```
Switch# show errdisable detect
ErrDisable Reason      Detection status
-----
bpduguard              Enabled
bpduloop               Enabled
link-monitor-failure   Enabled
oam-remote-failure     Enabled
port-security          Enabled
link-flap              Enabled
monitor-link           Enabled
udld                   Disabled
fdb-loop               Disabled
loopback-detection     Enabled
reload-delay           Enabled
```

Configuring Errdisable Recovery

step 1 Enter the configure mode

```
Switch# configure terminal
```

step 2 Enable errdisable and set recovery interval

```
Switch(config)# errdisable recovery reason link-flap
Switch(config)# errdisable recovery interval 30
```

step 3 Exit the configure mode

```
Switch(config)# end
```

step 4 Validation

Use the following command to display the configuration of error disable recovery:

```
Switch# show errdisable recovery
ErrDisable Reason      Timer Status
-----
bpduguard              Disabled
bpduloop               Disabled
link-monitor-failure   Disabled
oam-remote-failure     Disabled
port-security          Disabled
link-flap              Enabled
udld                   Disabled
fdb-loop               Disabled
loopback-detection     Disabled
Timer interval: 30 seconds
```

Configuring suppress Errdisable link Flap

step 1 Enter the configure mode

```
Switch# configure terminal
```

step 2 Set link flap condition

```
Switch(config)# errdisable flap reason link-flap 20 60
```

step 3 Exit the configure mode

```
Switch(config)# end
```

step 4 Validation

Use the following command to display the configuration of error disable flap:

```
Switch# show errdisable flap
ErrDisable Reason      Flaps      Time (sec)
```

Reason	Timer	Status
link-flap	20	60

Checking Errdisable Status

Administrator can check the interface errdisable status through two commands.

Case 1 Enable errdisable recovery

If link flap errdisable is enabled recovery, the command will display the left time for recovery; Otherwise, will display “unrecovery”.

```
Switch# show errdisable recovery
ErrDisable Reason      Timer Status
-----
bpduguard              Disabled
bpduloop               Disabled
link-monitor-failure   Disabled
oam-remote-failure     Disabled
port-security          Disabled
link-flap              Enabled
udld                   Disabled
fdb-loop               Disabled
loopback-detection     Disabled
Timer interval: 300 seconds
Interfaces that will be enabled at the next timeout:
Interface Errdisable Reason Time Left(sec)
-----
eth-0-3  link-flap          25
```

Case 2 Disalbe errdisable recovery

```
Switch# show errdisable recovery
ErrDisable Reason      Timer Status
-----
bpduguard              Disabled
bpduloop               Disabled
link-monitor-failure   Disabled
oam-remote-failure     Disabled
port-security          Disabled
link-flap              Disabled
udld                   Disabled
fdb-loop               Disabled
loopback-detection     Disabled
Timer interval: 300 seconds
```

case 3 Display interface brief information to check errdisable state.

```
Switch# show interface status
Port      Status      Duplex  Speed  Mode  Type      Description
```

eth-0-1	up	a-full	a-1000	TRUNK	1000BASE_SX
eth-0-2	down	auto	auto	TRUNK	Unknown
eth-0-3	errdisable	a-full	a-1000	TRUNK	1000BASE_SX
eth-0-4	down	auto	auto	ACCESS	Unknown

3.4.3 Application cases

N/A

3.5 Configuring MAC Address Table

3.5.1 Overview

Function Introduction

MAC address table contains address information for the switch to forward traffic between ports. The address table includes these types of address:

- Dynamic address: the source address learnt by the switch and will be aged after aging time if this address is not hit. We only support IVL learning mode.
- Static address: the source address manually added by administrators.

Following is a brief description of terms and concepts used to describe the MAC address table:

- IVL: Independent VLAN Learning: for a given set of VLANs, if a given individual MAC Address is learned in one VLAN, it can't be used in forwarding decisions taken for that address relative to any other VLAN in the given set.
- SVL: Shared VLAN Learning: for a given set of VLANs, if an individual MAC Address is learned in one VLAN, it can be used in forwarding decisions taken for that address relative to all other VLANs in the given set.

Reference to standard: IEEE 802.1D, IEEE 802.1Q

Principle Description

N/A

3.5.2 Configuration

Configuring Address Aging Time

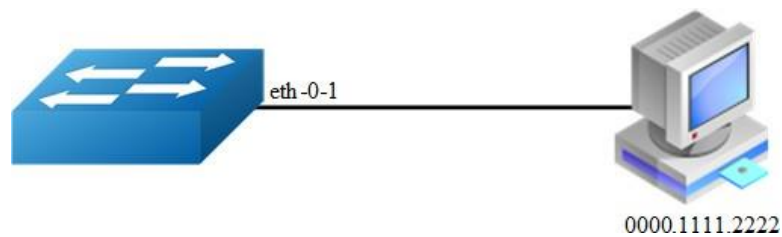

Figure 3-2 Mac address aging

The aging time is not exact time. If aging time set to N, then the dynamic address will be aged after N-2N interval. The default aging time is 300 seconds.

step 1 Enter the configure mode

```
Switch# configure terminal
```

step 2 Set dynamic address aging time

```
Switch(config)# mac-address-table ageing-time 10
```

step 3 Exit the configure mode

```
Switch(config)# end
```

step 4 Validation

Use the following command to display the aging time:

```
Switch# show mac address-table ageing-time  
MAC address table ageing time is 10 seconds
```

Configuring Static Unicast Address

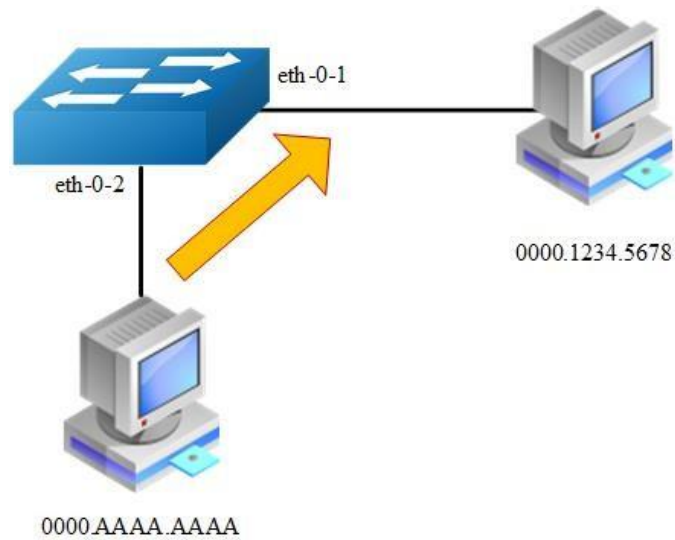

Figure 3-3 Static mac address table

Unicast address can be only bound to one port. According to the picture, Mac-Da 0000.1234.5678 should forward via eth-0-1.

step 1 Enter the configure mode

```
Switch# configure terminal
```

step 2 Set static mac address table

```
Switch(config)# mac-address-table 0000.1234.5678 forward eth-0-1 vlan 1
```

step 3 Exit the configure mode

```
Switch(config)# end
```

step 4 Validation

Use the following command to display the mac address table:

```
Switch# show mac address-table
Mac Address Table
-----
(*) - Security Entry
Vlan    Mac Address      Type    Ports
-----
1       0000.1234.5678  static eth-0-1
```

Configuring Static Multicast Address

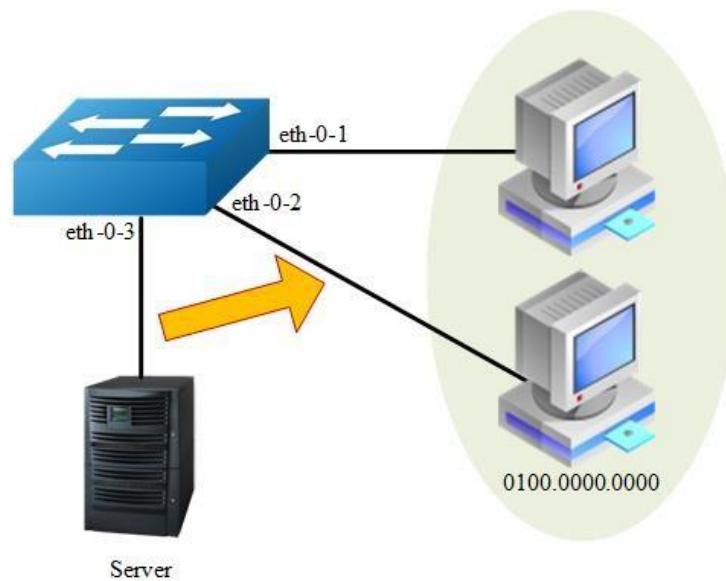

Figure 3-4 Static multicast mac address table

Multicast address can be bound to multi-port. According to the picture, Mac-Da 0100.0000.0000 can forward via eth-0-1 and eth-0-2.

step 1 Enter the configure mode

```
Switch# configure terminal
```

step 2 Set static multicast mac address table

```
Switch(config)# mac-address-table 0100.0000.0000 forward eth-0-1 vlan 1
Switch(config)# mac-address-table 0100.0000.0000 forward eth-0-2 vlan 1
```

step 3 Exit the configure mode

```
Switch(config)# end
```

step 4 Validation

Use the following command to display the mac address table:

```
Switch# show mac address-table
Mac Address Table
```

```
(*) - Security Entry
Vlan    Mac Address      Type      Ports
-----
```



```
1      0100.0000.0000    static    eth-0-1
                                     eth-0-2
```

Configuring MAC Filter Address

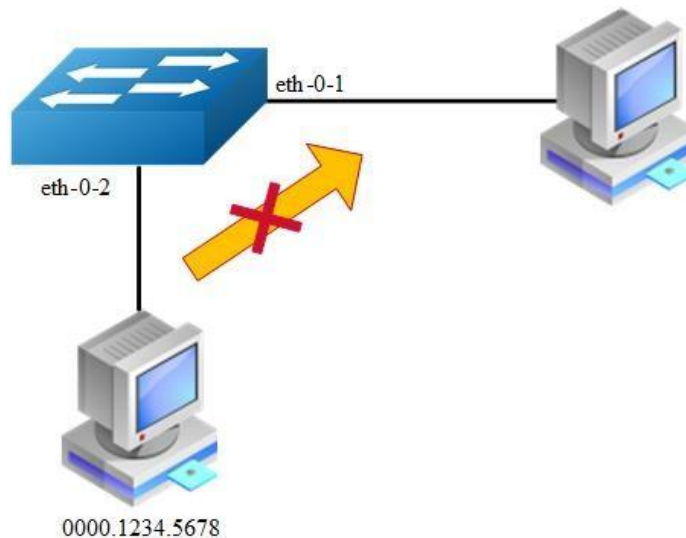

Figure 3-5 mac address filter

MAC filter will discard these frames whose source or destination address is set to discard. The MAC filter has higher priority than MAC address.

step 1 Enter the configure mode

```
Switch# configure terminal
```

step 2 Add unicast address to be discarded

```
Switch(config)# mac-address-table 0000.1234.5678 discard
```

step 3 Exit the configure mode

```
Switch(config)# end
```

step 4 Validation

Use the following command to display the mac address filter:

```
Switch# show mac-filter address-table
      MAC Filter Address Table
-----
Current count      : 1
Max count          : 128
```

```

Left count      : 127
Filter address list :
-----
0000.1234.5678

```

Configuring MAC Filter Address with special VLAN

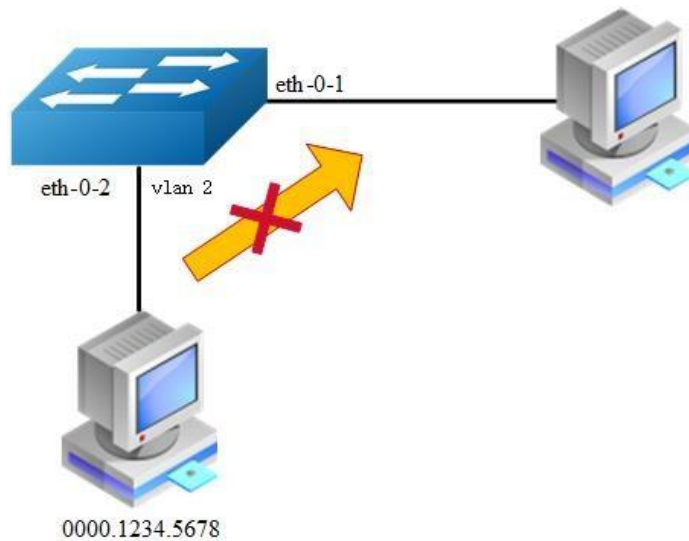

Figure 3-6 mac address filter with VLAN

MAC filter will discard these frames whose source or destination address is set to discard with VLAN matches. The MAC filter has higher priority than MAC address.

step 1 Enter the configure mode

```
Switch# configure terminal
```

step 2 Create VLAN

```
Switch(config)# vlan 2
```

step 3 Exit VLAN view

```
Switch(config-vlan)# exit
```

step 4 Add unicast address to be discarded

```
Switch(config)# mac-address-table 0000.1234.5678 discard vlan 2
```

step 5 Exit the configure mode

```
Switch(config)# end
```

step 6 Validation

Use the following command to display the mac address filter with special VLAN:

```
Switch# show mac address-table blackhole
      Mac Address Table
-----
(*) - Security Entry      (M) - MLAG Entry
(MO) - MLAG Output Entry  (MI) - MLAG Input Entry
(E) - EVPN Entry         (EO) - EVPN Output Entry
(EI) - EVPN Input Entry
Vlan  Mac Address      Type      Ports
-----
2     0000.1234.5678    blackhole drop
```

3.5.3 Application cases

N/A

3.6 Configuring VLAN

3.6.1 Overview

Function Introduction

VLAN (Virtual Local Area Network) is a switched network that is logically segmented the network into different broadcast domain so that packets are only switched between ports that are designated for the same VLAN. Each VLAN is considered as a logical network, and packets send to stations that do not belong to the same VLAN must be forwarded through a router.

Reference to standard: IEEE 802.1Q

Principle Description

Following is a brief description of terms and concepts used to describe the VLAN:

- VID: VLAN identifier
- LAN: Local Area Network

- VLAN: Virtual LAN
- PVID: Port VID, the untagged or priority-tagged frames will be assigned with this VID

Tagged Frame: Tagged Frame is inserted with 4 Bytes VLAN Tag, show in the picture below:

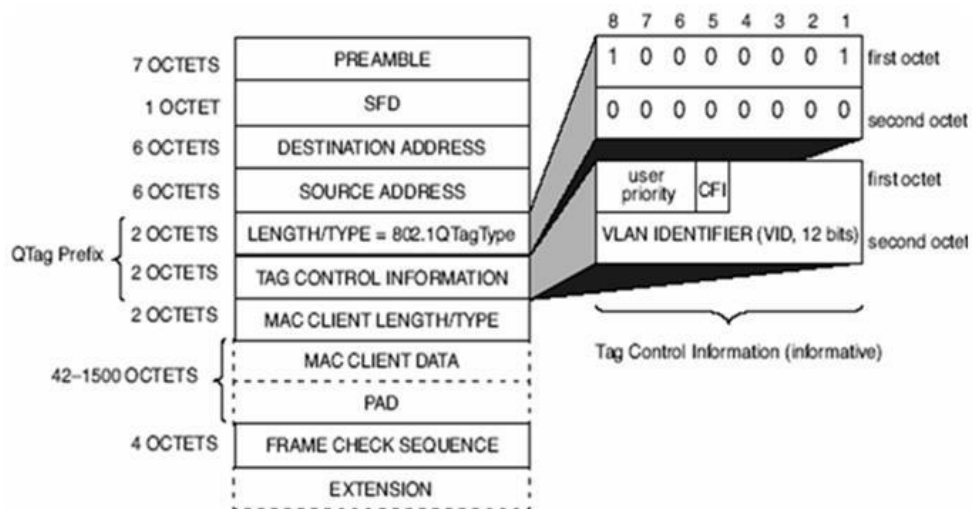

Figure 3-7 Tagged Frame

Trunk Link: Both tagged and untagged frames can be transmitted on this link. Trunk link allow for multiple VLANs to cross this link, show in the picture below:

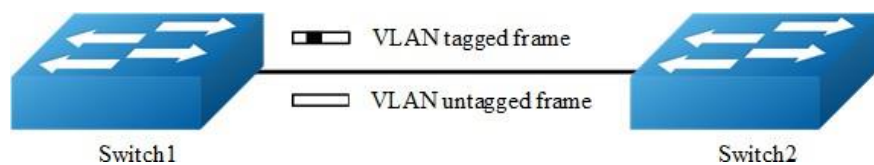

Figure 3-8 Trunk link

Access Link: Only untagged frames can be transmitted on this link. Access link is at the edge of the network, where end stations attach, show in the picture below:

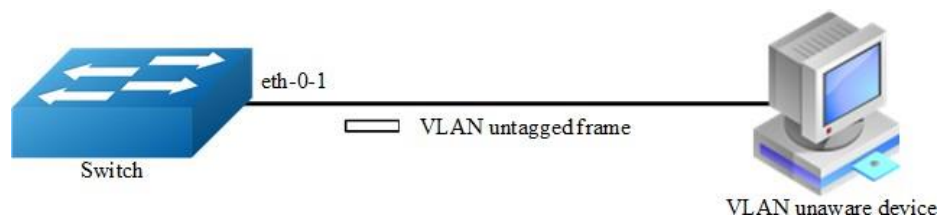

Figure 3-9 Access link

3.6.2 Configuration

Configuring Access Port

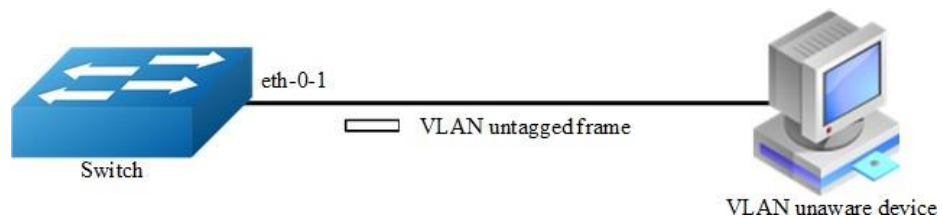

Figure 3-10 Access link

Access port only receives untagged or priority-tagged frames, and transmits untagged frames.

step 1 Enter the configure mode

```
Switch# configure terminal
```

step 2 Enter the vlan configure mode and create vlan

```
Switch(config)# vlan database
Switch(config-vlan)# vlan 2
Switch(config-vlan)# exit
```

step 3 Enter the interface configure mode, set the switch port mode and bind to the vlan

```
Switch(config)# interface eth-0-1
Switch(config-if)# switchport mode access
Switch(config-if)# switchport access vlan 2
```

step 4 Exit the configure mode

```
Switch(config-if)# end
```

step 5 Validation

Use the following command to display the information of the switch port interface:

```
Switch# show interface switchport interface eth-0-1
Interface name      : eth-0-1
Switchport mode    : access
Ingress filter     : enable
```

```
Acceptable frame types : vlan-untagged only
Default Vlan          : 2
Configured Vlans     : 2
```

Use the following command to display the vlan brief information:

```
Switch# show vlan brief
VLAN ID  Name           State   STP ID   Member ports
=====  =====
1        default        ACTIVE  0        eth-0-2(u) eth-0-3(u)
          eth-0-4(u) eth-0-5(u)
          eth-0-6(u) eth-0-7(u)
          eth-0-8(u) eth-0-9(u)
          eth-0-10(u) eth-0-11(u)
          eth-0-12(u) eth-0-13(u)
          eth-0-14(u) eth-0-15(u)
          eth-0-16(u) eth-0-17(u)
          eth-0-18(u) eth-0-19(u)
          eth-0-20(u) eth-0-21(u)
          eth-0-22(u) eth-0-23(u)
2        VLAN0002       ACTIVE  0        eth-0-1(u)
```

Configuring Trunk Port

Trunk port receives tagged, untagged, and priority-tagged frames, and transmits both untagged and tagged frames. If trunk port receives an untagged frame, this frame will be assigned to the VLAN of the trunk port's PVID; if a frame send out from the trunk port and the frame's VID is equal to the trunk port's PVID, this frame will be send out without VLAN tag.

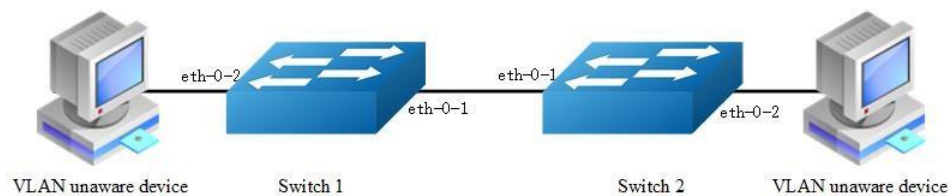

Figure 3-11 Trunk link

Network topology is shown in the picture above. The following configuration steps are same for Switch1 and Switch2.

step 1 Enter the configure mode

```
Switch# configure terminal
```

step 2 Enter the vlan configure mode and create vlan

```
Switch(config)# vlan database
Switch(config-vlan)# vlan 10,20
Switch(config-vlan)# exit
```

step 3 Enter the interface configure mode, set the switch port mode and bind to the vlan

Set eth-0-1's switch port mode as trunk, set native vlan as 10, and allow all VLANs on this interface:

```
Switch(config)# interface eth-0-1
Switch(config-if)# switchport mode trunk
Switch(config-if)# switchport trunk allowed vlan all
Switch(config-if)# switchport trunk native vlan 10
Switch(config-if)# exit
```

Set eth-0-2's switch port mode as access, and bind to vlan 10:

```
Switch(config)# interface eth-0-2
Switch(config-if)# switchport mode access
Switch(config-if)# switchport access vlan 10
Switch(config-if)# exit
```

step 4 Exit the configure mode

```
Switch(config-if)# end
```

step 5 Validation

Use the following command to display the information of the switch port interface:

```
Switch# show interface switchport
Interface name      : eth-0-1
Switchport mode    : trunk
Ingress filter     : enable
Acceptable frame types : all
Default Vlan       : 10
Configured Vlans   : 1 10 20
Interface name      : eth-0-2
Switchport mode    : access
Ingress filter     : enable
Acceptable frame types : vlan-untagged only
Default Vlan       : 10
Configured Vlans   : 10
```

Use the following command to display the vlan brief information:

```
Switch# show vlan brief
VLAN ID Name          State  STP ID  Member ports
```

				(u)-Untagged, (t)-Tagged	
=====					
1	default	ACTIVE	0	eth-0-1(t)	eth-0-3(u)
				eth-0-4(u)	eth-0-5(u)
				eth-0-6(u)	eth-0-7(u)
				eth-0-8(u)	eth-0-9(u)
				eth-0-10(u)	eth-0-11(u)
				eth-0-12(u)	eth-0-13(u)
				eth-0-14(u)	eth-0-15(u)
				eth-0-16(u)	eth-0-17(u)
				eth-0-18(u)	eth-0-19(u)
				eth-0-20(u)	eth-0-21(u)
				eth-0-22(u)	eth-0-23(u)
10	VLAN0010	ACTIVE	0	eth-0-1(t)	eth-0-2(u)
20	VLAN0020	ACTIVE	0	eth-0-1(t)	

3.6.3 Application cases

N/A

3.7 Configuring Voice VLAN

3.7.1 Overview

Function Introduction

With the development of the voice technology, the use of IP Phone/IAD(Integrated Access Device) is becoming more and more widespread in broadband community. Voice and data traffics are usually present in the network at the same time, therefore, voice traffics need higher priority to improve the performance and reduce the packet loss rate.

The traditional method to improve the quality of voice traffic is using ACL to separate the voice packets, and using QoS to ensure the transmit quality.

The voice VLAN feature can identify the voice packets by source mac, which makes the conguration more convenient.

Principle Description

N/A

3.7.2 Configuration

step 1 Enter the configure mode

```
Switch# configure terminal
```

step 2 Enter the vlan configure mode and create vlan

```
Switch(config)# vlan database
Switch(config-vlan)# vlan 2
Switch(config-vlan)# exit
```

step 3 Set the cos of voice vlan (Optional)

The default cos is 5.

```
Switch(config)# voice vlan set cos to 7
```

step 4 Set the voice vlan and create a mac entry for it

```
Switch(config)# voice vlan 2
Switch(config)# voice vlan mac-address 0055.0000.0000 ffff.ff00.0000 description
test
```

step 5 Enter the interface configure mode and enable voice vlan

```
Switch(config)# interface eth-0-1
Switch(config-if)# switchport mode trunk
Switch(config-if)# switchport trunk allowed vlan all
Switch(config-if)# voice vlan enable

Switch(config-if)# interface eth-0-2
Switch(config-if)# switchport mode trunk
Switch(config-if)# switchport trunk allowed vlan all
```

step 6 Validation

Send packet to eth-0-1, the format of the packet is as below (priority in Vlan tag is 0):

```
0x0000: 0000 0a02 0001 0055 0000 0011 8100 0002 .....k.....
0x0010: 0800 aadd aadd aadd aadd aadd aadd aadd .....
0x0020: aadd aadd aadd aadd aadd aadd aadd aadd .....
0x0030: aadd aadd aadd aadd aadd aadd .....

```

Receive packet from eth-0-2, the format of the packet received is as below (priority in Vlan tag is 5): .

```

0x0000:  0000 0a02 0001 0055 0000 0011 8100 a002  .....k.....
0x0010:  0800 aadd aadd aadd aadd aadd aadd aadd  .....
0x0020:  aadd aadd aadd aadd aadd aadd aadd aadd  .....
0x0030:  aadd aadd aadd aadd aadd aadd          .....

```

3.7.3 Application cases

N/A

3.8 Configuring VLAN Classification

3.8.1 Overview

Function Introduction

VLAN classification is used to define specific rules for directing packets to selected VLANs based on protocol or subnet criteria. Sets of rules can be grouped (one group per interface).

VLAN classification rules have 3 types: mac based, ip based and protocol based. MAC based vlan classification rule will classify packets to specified VLAN according to the source MAC address of incoming packets; IP based vlan classification rule will classify packets according to the source IP address of incoming packets; And protocol based vlan classification rule will classify packets according to the layer3 type of incoming packets. The following layer3 types can be supported: ARP, IP(v4), MPLS, Mcast MPLS, PPPoE, RARP.

Different types of vlan classification rules can be added to same vlan classification group. VLAN classification group can only be applied on switchport. Only one type of vlan classification rules can take effect on one switchport.

Principle Description

N/A

3.8.2 Configuration

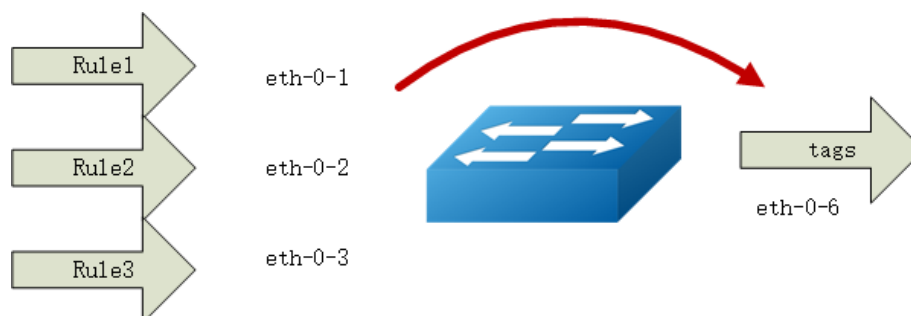

Figure 3-12 vlan classification

In this configuration example, three VLAN classifier rules are created:

Rule 1 is mac based rule, it will classify the packets with MACSA 2222.2222.2222 to vlan 5;

Rule 2 is ip based rule, it will classify the packets sourced from IP adress 1.1.1.1/24 to vlan 5;

Rule 3 is protocol based rule, it will classify all arp packets to vlan 5.

Add rule 1, rule2, rule3 to group 31. Then apply group 31 to 3 interfaces: eth-0-1, eth-0-2, eth-0-3. These 3 interfaces have different vlan classification type. eth-0-1 is configured to ip based vlan class, this means only ip based rules can take effect on this interface. eth-0-2 is configured to mac based vlan class, this means only mac based rules can take effect on this interface. eth-0-3 is configured to protocol based vlan class, this means only protocol based rules can take effect on this interface.

step 1 Enter the configure mode

```
Switch# configure terminal
```

step 2 Enter the vlan configure mode and create vlan

```
Switch(config)# vlan database
Switch(config-vlan)# vlan 5
Switch(config-vlan)# vlan 6
Switch(config-vlan)# exit
```

step 3 Create vlan classifier rule and add the rules to the group

```
Switch(config)# vlan classifier rule 1 mac 2222.2222.2222 vlan 5
Switch(config)# vlan classifier rule 2 ip 1.1.1.1 vlan 5
Switch(config)# vlan classifier rule 3 protocol arp vlan 5

Switch(config)# vlan classifier group 31 add rule 1
Switch(config)# vlan classifier group 31 add rule 2
Switch(config)# vlan classifier group 31 add rule 3
Switch(config)# arp as-layer-3 enable
```

step 4 Apply the vlan classifier group on the interface

interface eth-0-1:

```
Switch(config)# interface eth-0-1
Switch(config-if)# switchport access vlan 6
Switch(config-if)# switchport access allowed vlan add 5
Switch(config-if)# vlan classifier activate 31 based ip
Switch(config-if)# exit
```

interface eth-0-2:

```
Switch(config)# interface eth-0-2
Switch(config-if)# switchport access vlan 6
Switch(config-if)# switchport access allowed vlan add 5
Switch(config-if)# vlan classifier activate 31 based mac
Switch(config-if)# exit
```

interface eth-0-3:

```
Switch(config)# interface eth-0-3
Switch(config-if)# switchport access vlan 6
Switch(config-if)# switchport access allowed vlan add 5
Switch(config-if)# vlan classifier activate 31 based protocol
Switch(config-if)# exit
```

interface eth-0-6:

```
Switch(config)# interface eth-0-6
Switch(config)# switchport mode trunk
Switch(config-if)# switchport trunk allowed vlan add 5
Switch(config-if)# exit
```

step 5 Exit the configure mode

```
Switch(config)# end
```

step 6 Validation

Verify the VLAN classifier rules:

```
Switch# show vlan classifier rule
vlan classifier rule 1 mac 2222.2222.2222 vlan 5
vlan classifier rule 2 ip 1.1.1.1 vlan 5
vlan classifier rule 3 protocol arp vlan 5
```

Verify the VLAN classifier group:

```
Switch# show vlan classifier group
vlan classifier group 31 add rule 1
vlan classifier group 31 add rule 2
vlan classifier group 31 add rule 3
```

Verify the VLAN classifier interface:

```
Switch# show vlan classifier interface grou
vlan classifier group 31 on interface eth-0-2, based mac
vlan classifier group 31 on interface eth-0-1, based ip
vlan classifier group 31 on interface eth-0-3, based protocol
```

3.8.3 Application cases

N/A

3.9 Configuring VLAN Mapping

3.9.1 Overview

Function Introduction

Service-provider business customers often have specific requirements for VLAN IDs and the number of VLANs to be supported. The VLAN required by different customers in the same service-provider network might overlap, and traffic of customers through the infrastructure might be mixed. Assigning different VIDs to each customer to mapping their own's would bring the traffic from different customers separate. Using the VLAN translation feature, service providers can use a series of VLANs to support customers who have their own VLANs. Customer VLAN IDs are translated, and traffic from different customers is segregated within the service-provider infrastructure, even when they appear to be on the same VLAN.

802.1Q tunneling expands VLAN space by using a VLAN-in-VLAN hierarchy and tagging the tagged packets, and the maximal VLAN number can reach 4096×4096 . Using the 802.1Q tunneling feature, service providers can use a single VLAN to support clients which have multiple VLANs. The ISP usually builds a VLAN model to monitor

whole VLAN of backbone network by using GARP or GVRP and accelerate network convergence speed by using STP. Using 802.1Q tunneling as initial solution is right at first, but it can cause expansibility problem as clients increased. Some clients hope to bring their own VLAN ID which will face two problems. Firstly, the first client's VLAN tag may clash with the other clients. Secondly, the usable tags may be severely limited for the service-provider. The core network will have limits on the 4096 numbers VLAN, if the clients are permitted to use their respective VLAN ID by their own manner.

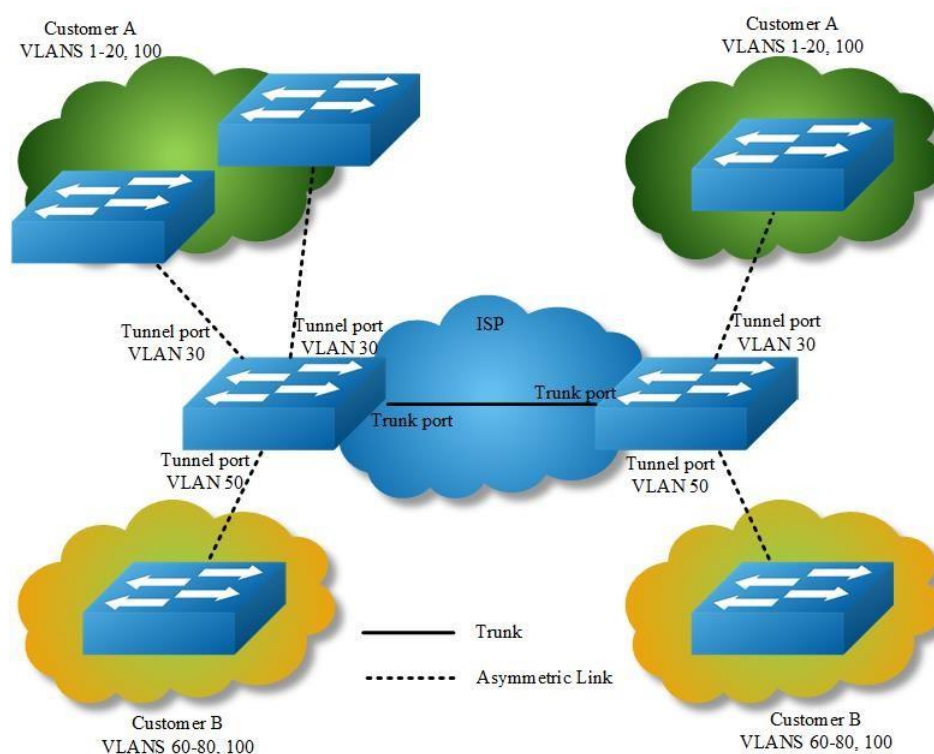

Figure 3-13 QinQ Tunnel

Using 802.1Q tunneling, the client's VLAN tag is encapsulated in the public VLAN tag and packets with two tags will traverse on backbone network. The client's VLAN tag will be shield and only the public VLAN tag will be used to transmit. By separating data stream, the client's VLAN tag is transmitted transparently and different VLAN tags can be used repeatedly. Therefore, using 802.1Q tunneling expands the available VLAN tags. Two types of 802.1q tunneling are supported: basic 802.1Q tunneling and selective 802.1Q tunneling. Basic 802.1Q tunneling is founded on tagging on ports and all dates will be encapsulated a common VLAN tag of the same port, so this type has great limitations in practical applications. While selective 802.1Q tunneling can separate data stream and encapsulate different VLAN tags base on different data.

Principle Description

N/A

3.9.2 Configuration

Configuring VLAN Translation



Figure 3-14 vlan mapping

step 1 Enter the configure mode

```
Switch# configure terminal
```

step 2 Enter the vlan configure mode and create vlan

```
Switch(config)# vlan database
Switch(config-vlan)# vlan 2,3
Switch(config-vlan)# exit
```

step 3 Create evc and set dot1q mapped vlan

```
Switch(config)# ethernet evc evc_c1
Switch(config-evc)# dot1q mapped-vlan 2
Switch(config)# ethernet evc evc_c2
Switch(config-evc)# dot1q mapped-vlan 3
```

step 4 Create vlan mapping table and bind the vlan and evc

```
Switch(config)# vlan mapping table vm
Switch(config-vlan-mapping)# raw-vlan 10 evc evc_c1
Switch(config-vlan-mapping)# raw-vlan 20 evc evc_c2
Switch(config-vlan-mapping)# exit
```

step 5 Enable vlan translation on the interface and apply the vlan mapping table

```
Switch(config)# interface eth-0-1
Switch(config-if)# switchport mode trunk
Switch(config-if)# switchport trunk vlan-translation
Switch(config-if)# switchport trunk vlan-translation mapping table vm
Switch(config-if)# switchport trunk allowed vlan add 2,3

Switch(config-if)# interface eth-0-2
Switch(config-if)# switchport mode trunk
Switch(config-if)# switchport trunk allowed vlan add 2,3
Switch(config-if)# exit
```

step 6 Exit the configure mode

```
Switch(config)# end
```

step 7 Validation

Use the following command to display the information of the switch port interface:

```
Switch# show interface switchport interface eth-0-1
Interface name      : eth-0-1
Switchport mode    : trunk
VLAN traslation    : enable
VLAN mapping table : vm
Ingress filter     : enable
Acceptable frame types : all
Default Vlan      : 1
Configured Vlans  : 1 2 3
```

Use the following command to display the information of the vlan mapping table:

```
Switch# show vlan mapping table
Table Name      EVC Name      Mapped VLAN Raw VLAN
=====
vm              evc_c1        2            10
               evc_c2        3            20
```

Configuring 802.1q Tunneling (Basic 802.1Q tunneling)



Figure 3-15 QinQ Tunnel**step 1 Enter the configure mode**

```
Switch# configure terminal
```

step 2 Enter the interface configure mode, set the switch port mode

```
Switch(config)# interface eth-0-1
Switch(config-if)# no shutdown
Switch(config-if)# switchport mode dot1q-tunnel
```

step 3 Exit the configure mode

```
Switch(config-if)# end
```

step 4 Validation

This example shows how to configure a switchport to basic dot1q-tunnel port. You can use show the configuration on the switchport:

```
Switch# show interface switchport interface eth-0-1
Interface name          : eth-0-1
Switchport mode        : dot1q-tunnel(basic)
Ingress filter         : enable
Acceptable frame types : all
Default Vlan           : 1
Configured Vlans       : 1
```

Configuring 802.1q Tunneling (Selective 802.1Q tunneling, Add one tag for incoming untagged packet.)

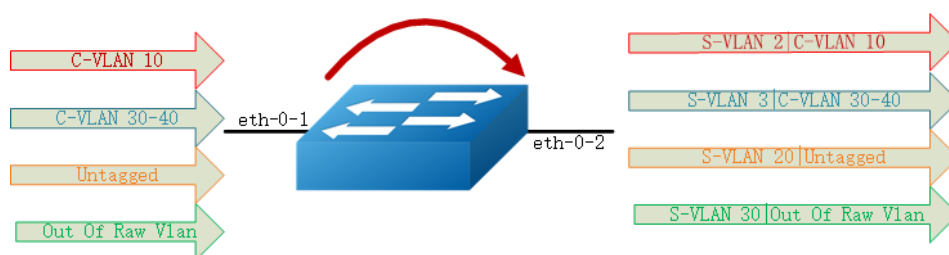
**Figure 3-16 QinQ Tunnel****step 1 Enter the configure mode**

```
Switch# configure terminal
```

step 2 Enter the vlan configure mode and create vlan

```
Switch(config)# vlan database
Switch(config-vlan)# vlan 2,3,20,30
Switch(config-vlan)# exit
```

step 3 Create evc and set dot1q mapped vlan

```
Switch(config)# ethernet evc evc_c1
Switch(config-evc)# dot1q mapped-vlan 2
Switch(config)# ethernet evc evc_c2
Switch(config-evc)# dot1q mapped-vlan 3
Switch(config)# ethernet evc evc_c3
Switch(config-evc)# dot1q mapped-vlan 20
Switch(config)# ethernet evc evc_c4
Switch(config-evc)# dot1q mapped-vlan 30
Switch(config-evc)# exit
```

step 4 Create vlan mapping table and bind the vlan and evc

```
Switch(config)# vlan mapping table vm
Switch(config-vlan-mapping)# raw-vlan 10 evc evc_c1
Switch(config-vlan-mapping)# raw-vlan 30-40 evc evc_c2
Switch(config-vlan-mapping)# raw-vlan untagged evc evc_c3
Switch(config-vlan-mapping)# raw-vlan out-of-range evc evc_c4
Switch(config-vlan-mapping)# exit
```

step 5 Enable vlan translation on the interface and apply the vlan mapping table

eth-0-1:

```
Switch(config-if)# switchport mode dot1q-tunnel
Switch(config-if)# switchport dot1q-tunnel type selective
Switch(config-if)# switchport dot1q-tunnel vlan mapping table vm
Switch(config-if)# switchport dot1q-tunnel allowed vlan add 2,3,20,30
```

eth-0-2:

```
Switch(config-if)# switchport mode trunk
Switch(config-if)# switchport trunk allowed vlan add 2,3,20,30
```

step 6 Exit the configure mode

```
Switch(config-if)# end
```

step 7 Validation

This example shows how to configure a switchport to selective dot1q-tunnel port:

```
Switch# show interface switchport interface eth-0-1
Interface name       : eth-0-1
Switchport mode     : dot1q-tunnel(selective)
VLAN mapping table  : vm
Ingress filter      : enable
Acceptable frame types : all
Default Vlan        : 1
Configured Vlans    : 1    2    3    20   30
```

Use the following command to display the information of the vlan mapping table:

```
Switch# show vlan mapping table
Table Name          EVC Name          Mapped VLAN Raw VLAN
=====
vm                  evc_c1             2             10
                   evc_c2             3             30-40
                   evc_c3             20            untagged
                   evc_c4             30            out-of-range
```

Configuring 802.1q Tunneling (Selective 802.1Q tunneling, Add two tags for incoming untagged packet.)

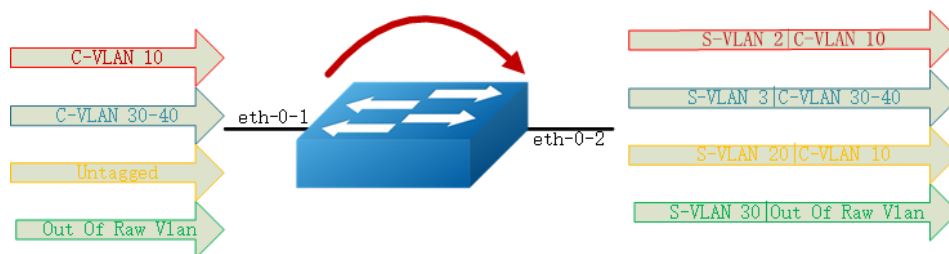

Figure 3-17 QinQ Tunnel

step 1 Enter the configure mode

```
Switch# configure terminal
```

step 2 Enter the vlan configure mode and create vlan

```
Switch(config)# vlan database
Switch(config-vlan)# vlan 2,3,10,20,30
Switch(config-vlan)# exit
```

step 3 Create evc and set dot1q mapped vlan

```
Switch(config)# ethernet evc evc_c1
Switch(config-etc)# dot1q mapped-vlan 2
Switch(config-etc)# exit
Switch(config)# ethernet evc evc_c2
```

```
Switch(config-evc)# dot1q mapped-vlan 3
Switch(config-evc)# exit
Switch(config)# ethernet evc evc_c3
Switch(config-evc)# dot1q mapped-double-vlan 10 20
Switch(config-evc)# exit
Switch(config)# ethernet evc evc_c4
Switch(config-evc)# dot1q mapped-vlan 30
Switch(config-evc)# exit
```

step 4 Create vlan mapping table and bind the vlan and evc

```
Switch(config)# vlan mapping table vm
Switch(config-vlan-mapping)# raw-vlan 10 evc evc_c1
Switch(config-vlan-mapping)# raw-vlan 30-40 evc evc_c2
Switch(config-vlan-mapping)# raw-vlan untagged evc evc_c3
Switch(config-vlan-mapping)# raw-vlan out-of-range evc evc_c4
Switch(config-vlan-mapping)# raw-vlan 10 20 egress-vlan untag
Switch(config-vlan-mapping)# exit
```

step 5 Enable vlan translation on the interface and apply the vlan mapping table

eth-0-1:

```
Switch(config)# interface eth-0-1
Switch(config-if)# switchport mode dot1q-tunnel
Switch(config-if)# switchport dot1q-tunnel type selective
Switch(config-if)# switchport dot1q-tunnel vlan mapping table vm
Switch(config-if)# switchport dot1q-tunnel native inner-vlan 10
Switch(config-if)# switchport dot1q-tunnel allowed vlan add 2,3,20,30
Switch(config-if)# exit
```

eth-0-2:

```
Switch(config)# interface eth-0-2
Switch(config-if)# switchport mode trunk
Switch(config-if)# switchport trunk allowed vlan add 2,3,20,30
Switch(config-if)# exit
```

step 6 Exit the configure mode

```
Switch(config)# end
```

step 7 Validation

This example shows how to configure a switchport to selective dot1q-tunnel port:

```
Switch# show interface switchport interface eth-0-1
Interface name      : eth-0-1
Switchport mode    : dot1q-tunnel(selective)
VLAN mapping table : vm
```

```

Ingress filter      : enable
Acceptable frame types : all
Default Vlan       : 10
Configured Vlans   : 1    2    3    20   30

```

Use the following command to display the information of the vlan mapping table:

Table Name	EVC Name	Mapped VLAN	Raw VLAN
vm	evc_c1	2	10
	evc_c2	3	30-40
	evc_c3	20 (10)	untagged
	evc_c4	30	out-of-range

3.9.3 Application cases

N/A

3.10 Configuring Link Aggregation

3.10.1 Overview

Function Introduction

This chapter contains a sample configuration of Link Aggregation Control Protocol (LACP). LACP is based on the 802.3ad IEEE specification. It allows bundling of several physical interfaces to form a single logical channel providing enhanced performance and redundancy. The aggregated interface is viewed as a single link to each switch. The spanning tree views it as one interface. When there is a failure in one physical interface, the other interfaces stay up and there is no disruption. This implementation supports the aggregation of maximum 16 physical Ethernet links into a single logical channel. LACP enables our device to manage link aggregation group between other devices that conform to the 802.3ad protocol. By using the LACP, the switch learns the identity of partners supporting LACP and the capabilities of each port. It then dynamically groups ports with same properties into a single logical bundle link.

Reference to standard IEEE 802.3ad.

Principle Description

N/A

3.10.2 Configuration

Configure dynamic lacp

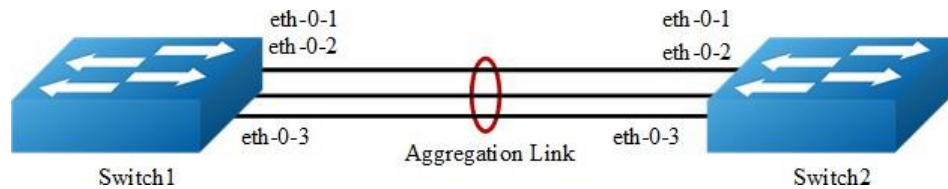

Figure 3-18 Dynamic LACP

The configurations of Switch1 and Switch2 are as below:

step 1 Enter the configure mode

```
Switch# configure terminal
```

step 2 Set the global attributes of LACP

Set the dynamic lacp mode of aggregation groups.

Switch1 configuration:

```
Switch(config)# port-channel 1 lacp-mode dynamic
```

Switch2 configuration:

```
Switch(config)# port-channel 1 lacp-mode dynamic
```

step 3 Enter the interface configure mode and add the interface to the channel group

```
Switch(config)# interface eth-0-1
Switch(config-if)# no shutdown
Switch(config-if)# channel-group 1 mode active
Switch(config-if)# exit
Switch(config)# interface eth-0-2
Switch(config-if)# channel-group 1 mode active
Switch(config-if)# no shutdown
Switch(config-if)# exit
Switch(config)# interface eth-0-3
Switch(config-if)# channel-group 1 mode active
Switch(config-if)# no shutdown
Switch(config-if)# exit
```

step 4 Exit the configure mode

```
Switch(config)# end
```

step 5 Validation

Use the following command to display the information of the channel-group:

```
Switch# show channel-group summary
port-channel load-balance hash-arithmetic: xor
port-channel load-balance hash-field-select:
  macsa
Flags: s - suspend          T - standby
      D - down/admin down  B - in Bundle
      R - Layer3           S - Layer2
      w - wait             U - in use
Mode:  SLB - static load balance
      DLB - dynamic load balance
      SHLB - self-healing load balance
      RR - round robin load balance
Aggregator Name  Mode      Protocol      Ports
-----+-----+-----+
agg1(SU)         SLB       LACP(Dynamic) eth-0-1(B) eth-0-2(B) eth-0-3(B)
```

Use the following command to display the information of the interface agg:

```
Switch1# show interface agg1
Interface agg1
  Interface current state: UP
  Hardware is AGGREGATE, address is cce3.33fc.330b (bia cce3.33fc.330b)
  Bandwidth 3000000 kbits
  Index 1025 , Metric 1 , Encapsulation ARPA
  Speed - 1000Mb/s , Duplex - Full , Media type is Aggregation
  Link speed type is autonegotiation, Link duplex type is autonegotiation
  Input flow-control is off, output flow-control is off
  The Maximum Frame Size is 1534 bytes
  VRF binding: not bound
  Label switching is disabled
  No virtual circuit configured
  ARP timeout 01:00:00, ARP retry interval 1s
  5 minute input rate 0 bits/sec, 0 packets/sec
  5 minute output rate 2 bits/sec, 0 packets/sec
  13 packets input, 1184 bytes
  Received 0 unicast, 0 broadcast, 0 multicast
  0 runts, 0 giants, 0 input errors, 0 CRC
  0 frame, 0 overrun, 0 pause input
  0 input packets with dribble condition detected
  20 packets output, 2526 bytes
  Transmitted 0 unicast, 0 broadcast, 0 multicast
  0 underruns, 0 output errors, 0 pause output
```

Configure channel-group

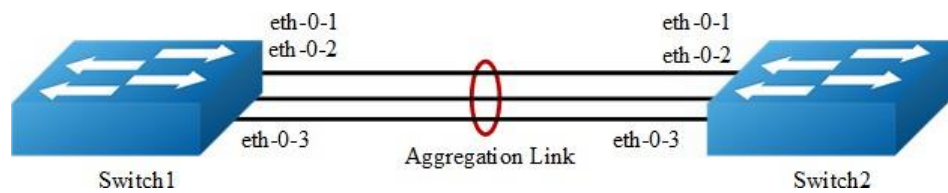

Figure 3-19 Static LACP

The configurations of Switch1 and Switch2 are as below:

step 1 Enter the configure mode

```
Switch# configure terminal
```

step 2 Set the global attributes of LACP

Set the system priority of this switch. This priority is used for determining the system that is responsible for resolving conflicts in the choice of aggregation groups. A lower numerical value has a higher priority. Set the load balance mode. In this case we choose source MAC address for load balance.

Switch1 configuration:

```
Switch(config)# lacp system-priority 2000
Switch(config)# hash-field port-channel
Switch(config-hash-field)# 12 macsa
```

Switch2 configuration:

```
Switch(config)# lacp system-priority 1000
Switch(config)# hash-field port-channel
Switch(config-hash-field)# 12 macsa
```

step 3 Enter the interface configure mode and add the interface to the channel group

```
Switch(config)# interface eth-0-1
Switch(config-if)# no shutdown
Switch(config-if)# channel-group 1 mode active
Switch(config-if)# exit
Switch(config)# interface eth-0-2
Switch(config-if)# channel-group 1 mode active
Switch(config-if)# no shutdown
Switch(config-if)# exit
Switch(config)# interface eth-0-3
```



```
Switch(config-if)# channel-group 1 mode active
Switch(config-if)# no shutdown
Switch(config-if)# exit
```

step 4 Exit the configure mode

```
Switch(config)# end
```

step 5 Validation

Use the following command to display the information of the channel-group:

```
Switch# show channel-group summary
port-channel load-balance hash-arithmetic: xor
port-channel load-balance hash-field-select:
  macsa
Flags: s - suspend          T - standby
      D - down/admin down  B - in Bundle
      R - Layer3           S - Layer2
      w - wait             U - in use
Mode:  SLB - static load balance
      DLB - dynamic load balance
      SHLB - self-healing load balance
      RR - round robin load balance
Aggregator Name  Mode      Protocol      Ports
-----+-----+-----+
agg1(SU)         SLB       LACP          eth-0-1(B) eth-0-2(B) eth-0-3(B)
```

Use the following command to display the information of the interface agg:

```
Switch1# show interface agg1
Interface agg1
  Interface current state: UP
  Hardware is AGGREGATE, address is cce3.33fc.330b (bia cce3.33fc.330b)
  Bandwidth 3000000 kbits
  Index 1025 , Metric 1 , Encapsulation ARPA
  Speed - 1000Mb/s , Duplex - Full , Media type is Aggregation
  Link speed type is autonegotiation, Link duplex type is autonegotiation
  Input flow-control is off, output flow-control is off
  The Maximum Frame Size is 1534 bytes
  VRF binding: not bound
  Label switching is disabled
  No virtual circuit configured
  ARP timeout 01:00:00, ARP retry interval 1s
  5 minute input rate 0 bits/sec, 0 packets/sec
  5 minute output rate 2 bits/sec, 0 packets/sec
  13 packets input, 1184 bytes
  Received 0 unicast, 0 broadcast, 0 multicast
  0 runts, 0 giants, 0 input errors, 0 CRC
  0 frame, 0 overrun, 0 pause input
  0 input packets with dribble condition detected
  20 packets output, 2526 bytes
```

```
Transmitted 0 unicast, 0 broadcast, 0 multicast
0 underruns, 0 output errors, 0 pause output
```

Configuring Static-channel-group

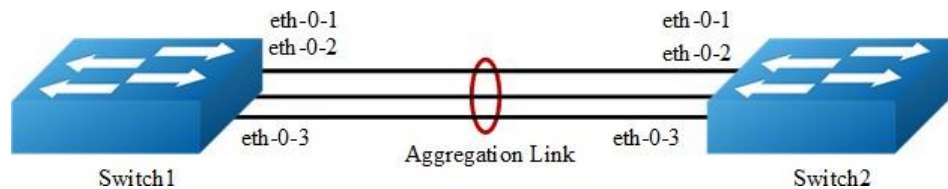

Figure 3-20 Static Agg

The configurations of Switch1 and Switch2 are as below:

step 1 Enter the configure mode

```
Switch# configure terminal
```

step 2 Enter the interface configure mode and add the interface to the channel group

```
Switch(config)# interface eth-0-1
Switch(config-if)# no shutdown
Switch(config-if)# static-channel-group 1
Switch(config-if)# exit
Switch(config)# interface eth-0-2
Switch(config-if)# static-channel-group 1
Switch(config-if)# no shutdown
Switch(config-if)# exit
Switch(config)# interface eth-0-3
Switch(config-if)# static-channel-group 1
Switch(config-if)# no shutdown
Switch(config-if)# exit
```

step 3 Exit the configure mode

```
Switch(config)# end
```

step 4 Validation

Use the following command to display the information of the channel-group:

```
Switch1# show channel-group summary
port-channel load-balance hash-arithmetic: xor
port-channel load-balance hash-field-select:
    macsa
Flags:  s - suspend          T - standby
```

```

    D - down/admin down   B - in Bundle
    R - Layer3             S - Layer2
    w - wait               U - in use
Mode:  SLB - static load balance
       DLB - dynamic load balance
       SHLB - self-healing load balance
       RR  - round robin load balance
Aggregator Name  Mode      Protocol      Ports
-----+-----+-----+
agg1(SU)         SLB      Static        eth-0-1(B) eth-0-2(B) eth-0-3(B)

```

Use the following command to display the information of the interface agg:

```

Switch1# show interface agg 1
Interface agg1
  Interface current state: UP
  Hardware is AGGREGATE, address is cce3.33fc.330b (bia a876.6b2c.9c01)
  Bandwidth 3000000 kbits
  Index 1025 , Metric 1 , Encapsulation ARPA
  Speed - 1000Mb/s , Duplex - Full , Media type is Aggregation
  Link speed type is autonegotiation, Link duplex type is autonegotiation
  Input flow-control is off, output flow-control is off
  The Maximum Frame Size is 1534 bytes
  VRF binding: not bound
  Label switching is disabled
  No virtual circuit configured
  ARP timeout 01:00:00, ARP retry interval 1s
  5 minute input rate 0 bits/sec, 0 packets/sec
  5 minute output rate 140 bits/sec, 0 packets/sec
    0 packets input, 0 bytes
  Received 0 unicast, 0 broadcast, 0 multicast
    0 runts, 0 giants, 0 input errors, 0 CRC
    0 frame, 0 overrun, 0 pause input
    0 input packets with dribble condition detected
  1080 packets output, 60614 bytes
  Transmitted 0 unicast, 0 broadcast, 0 multicast
  0 underruns, 0 output errors, 0 pause output

```

3.10.3 Application cases

N/A

3.11 Configuring Flow Control

3.11.1 Overview

Function Introduction

Flow control enables connected Ethernet ports to control traffic rates during congestion by allowing congested nodes to pause link operation at the other end. If one port experiences congestion and cannot receive any more traffic, it notifies the other port to stop sending until the condition clears. When the local device detects any congestion at its end, it can notify the link partner or the remote device of the congestion by sending a pause frame. You can use the flowcontrol interface configuration command to set the interface's ability to receive and send pause frames to on, off. The default state for ports is receive off and send off. In auto-negotiation link, local device's flow control ability can be notified to link partner by link up/down.



NOTE

Flow control send/receive on ability only works on full duplex link

Principle Description

N/A

3.11.2 Configuration

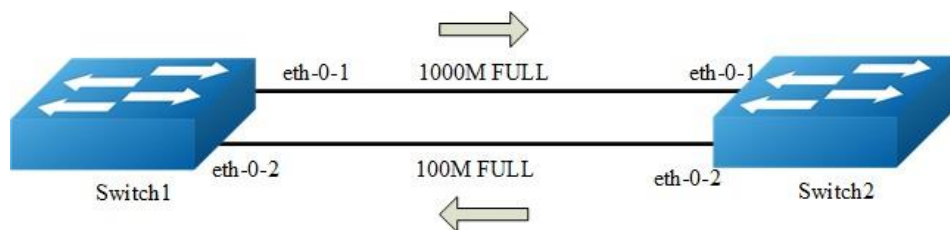

Figure 3-21 Flow control

Configuring Flow Control Send

step 1 Enter the configure mode

```
Switch# configure terminal
```

step 2 Enter the interface configure mode and enable flowcontrol send

```
Switch(config)# interface eth-0-1
Switch(config-if)# flowcontrol send on
```

step 3 Exit the configure mode

```
Switch(config-if)# end
```

step 4 Validation

Use the following command to display the information of flow control:

```
Switch# show flowcontrol
```

Port	Receive FlowControl		Send FlowControl		RxPause	TxPause
	admin	oper	admin	oper		
eth-0-1	off	off	on	on	0	0
eth-0-2	off	off	off	off	0	0
eth-0-3	off	off	off	off	0	0

Use the following command to display the information of flow control on specified interface:

```
Switch# show flowcontrol eth-0-1
```

Port	Receive FlowControl		Send FlowControl		RxPause	TxPause
	admin	oper	admin	oper		
eth-0-1	off	off	on	on	0	0

Configuring Flow Control Receive

step 1 Enter the configure mode

```
Switch# configure terminal
```

step 2 Enter the interface configure mode and enable flowcontrol send

```
Switch(config)# interface eth-0-1
Switch1(config-if)# flowcontrol receive on
```

step 3 Exit the configure mode

```
Switch(config-if)# end
```

step 4 Validation

Use the following command to display the information of flow control:

```
Switch1# show flowcontrol
Port          Receive FlowControl  Send FlowControl  RxPause  TxPause
              admin   oper      admin   oper
-----
eth-0-1      on     on        off    off      0        0
eth-0-2      off    off        off    off      0        0
eth-0-3      off    off        off    off      0        0
```

Use the following command to display the information of flow control on specified interface:

```
Switch1# show flowcontrol eth-0-1
Port          Receive FlowControl  Send FlowControl  RxPause  TxPause
              admin   oper      admin   oper
-----
eth-0-1      on     on        off    off      0        0
```

3.11.3 Application cases

N/A

3.12 Configuring Storm Control

3.12.1 Overview

Function Introduction

Storm control prevents traffic on a LAN from being disrupted by a broadcast, a multicast, or a unicast storm on one of the physical interfaces. A LAN storm occurs when packets flood the LAN, creating excessive traffic and degrading network performance.

Storm control uses one of these methods to measure traffic activity:

- Bandwidth as a percentage of the total available bandwidth of the port (Level mode).

- Traffic rate in packets per second of the port (PPS mode).

PPS = Packets per second

Principle Description

N/A

3.12.2 Configuration

Configuring Bandwidth Percentage Storm Control

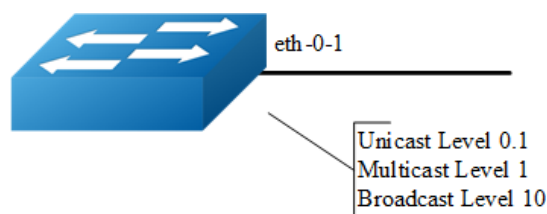

Figure 3-22 Percentage Storm Control

step 1 Enter the configure mode

```
Switch# configure terminal
```

step 2 Enter the interface configure mode, and set the storm control level

User can set different level for Unknown unicast/multicast/broad cast packets:

```
Switch(config)# interface eth-0-1
Switch(config-if)# storm-control unicast level 0.1
Switch(config-if)# storm-control multicast level 1
Switch(config-if)# storm-control broadcast level 10
```

step 3 Exit the configure mode

```
Switch(config-if)# end
```

step 4 Validation

```
Switch# show storm-control interface eth-0-1
Port      ucastMode ucastlevel  bcastMode bcastLevel  mcastMode mcastLevel
-----
eth-0-1   Level     0.10       Level     10.00      Level     1.00
```

Configuring Packets per-Second Storm Control

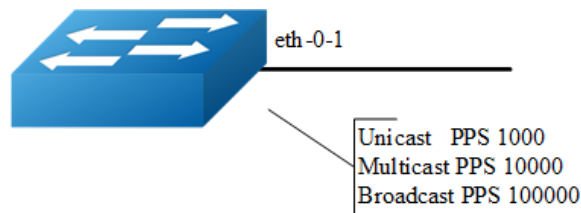

Figure 3-23 PPS Storm Control

step 1 Enter the configure mode

```
Switch# configure terminal
```

step 2 Enter the interface configure mode, and set the storm control pps

User can set different pps for Unknown unicast/multicast/broad cast packets:

```
Switch(config)# interface eth-0-1
Switch(config-if)# storm-control unicast pps 1000
Switch(config-if)# storm-control multicast pps 10000
Switch(config-if)# storm-control broadcast pps 100000
```

step 3 Exit the configure mode

```
Switch(config-if)# end
```

step 4 Validation

```
Switch# show storm-control interface eth-0-1
```

Port	ucastMode	ucastlevel	bcastMode	bcastLevel	mcastMode	mcastLevel
eth-0-1	PPS	1000	PPS	100000	PPS	10000

3.12.3 Application cases

N/A

3.13 Configuring Loopback Detection

3.13.1 Overview

Function Introduction

The loopback in the networks would cause the device continued to send broadcast, multicast and unknow unicast packets. It will waste the resource of network even paralysis the whole network. To detect the loopback in the layer 2 network rapidly and avoid to effect the whole network, system need to provide a detection function to notice the user checking the network connection and configuration, and control the error interface when the network appears loopback.

Loopback Detection can detects whether the interface of device exists loopback. When enable loopback detection on a interface, device will send detection packets from this interface by periodically. If the device receives detection packets sent from the interface, this interface is considered that there is a loop existed and the device can send alarm information to network management system. Administrators discover loopback problem throught alarm information and resolve the problem to avoid longtime network abnormal. In addition, the device can control the specific interface and configured Trap according the requirement, and disable the interface to quickly reduce the impact in the network of loopback to the minimum.

Principle Description

N/A

3.13.2 Configuration

Enable Loopback Detect

step 1 Enter the configure mode

```
Switch# configure terminal
```

step 2 Enter the interface configure mode, and enable Loopback Detect

```
Switch(config)# interface eth-0-1
Switch(config-if)# loopback-detect enable
```

step 3 Exit the configure mode

```
Switch(config-if)# end
```

step 4 Validation

By default, loopback detection is disable. When the interface enable loopback detection, system send the detection packets to detect the loopback. Default detection packets transmission interval is 5 second.

Use the following command to display the loopback detection states:

```
Switch# show loopback-detect
Loopback detection packet interval(second): 5
Loopback detection recovery time(second): 15
Interface      Action      Status
eth-0-2        shutdown    NORMAL
```

Configuring Loopback Detect packet interval

The network is changing all the time, therefor the loopback detection is an continued process. The interface sent loopback detection packets in a certain interval of time, the packets transimission time is loopback detection packets sending period.

The device send the lopback detection packets time interval range is 1 to 300 seconds.The loopback status recover period default is 3 times of the interface send interval.

step 1 Enter the configure mode

```
Switch# configure terminal
```

step 2 set the packet interval of Loopback Detect

```
Switch(config)# loopback-detect packet-interval 10
```

step 3 Exit the configure mode

```
Switch(config)# end
```

step 4 Validation

Use the following command to display the packet interval of Loopback Detect:

```
Switch# show loopback-detect packet-interval
Loopback detection packet interval(second): 10
```

Configuring Loopback Detect action

If a loopback is detected on the interface and loopback is enabled on this interface, the system can configure an action to send alarm, shutdown the interface, block the interface or other action.

After loopback detection is enabled on an interface, the interface sends loopback detection packets at intervals. When a loopback is detected on the interface, the system performs an action to minimize the impact on the entire network.

step 1 Enter the configure mode

```
Switch# configure terminal
```

step 2 Enter the interface configure mode, and set the action of Loopback Detect

```
Switch(config)# interface eth-0-1
Switch(config-if)# loopback-detect action shutdown
```

step 3 Exit the configure mode

```
Switch(config)# end
```

step 4 Validation

Use the following command to display the information of Loopback Detect on the interface:

```
Switch# show loopback-detect interface eth-0-1
Interface      Action      Status
eth-0-1        shutdown    NORMAL
```

Configuring specify VLAN Loopback Detection

specify the VLAN IDs of loopback detection packets on an interface After loopback detection is enabled on an interface, system send untagged loopback detection

packets by default. It means the device doesn't detect any specify vlan loopback packets. When interface is configured Tagged mode in vlan, the loopback detection packets sent by this interface will be discard on the link, and interface won't receive the loop packets which is sent by itself. So we should specify the VLAN IDs of loopback detection packets on an interface.

After the loopback-detect packet vlan command is executed on an interface, the interface sends an untagged loopback detection packet and the loopback detection packets with the specified VLAN tags. The specified VLANs exist and the interface has been added to the VLANs in tagged mode. If you run the loopback-detect packet vlan command multiple times in the same interface view, multiple VLAN IDs are specified. You can specify a maximum of eight VLAN IDs

step 1 Enter the configure mode

```
Switch# configure terminal
```

step 2 Enter the interface configure mode, and set the specify vlan of Loopback Detect

```
Switch(config)# interface eth-0-1
Switch(config-if)# loopback-detect packet vlan 20
```

step 3 Exit the configure mode

```
Switch(config-if)# end
```

step 4 Validation

Use the following command to display the configuration of Loopback Detect:

```
Switch# show running-config interface eth-0-1
Building configuration...
!
interface eth-0-1
 loopback-detect enable
 loopback-detect packet vlan 20
!
```

3.13.3 Application cases

N/A

3.14 Configuring Layer 2 Protocols Tunneling

3.14.1 Overview

Function Introduction

Customers at different sites connected across a service-provider network need to run various Layer 2 protocols to scale their topology to include all remote sites, as well as the local sites. STP must run properly, and every VLAN should build a proper spanning tree that includes the local site and all remote sites across the service-provider infrastructure.

When Layer 2 protocol tunneling is enabled, edge switches on the inbound side of the service-provider infrastructure encapsulate Layer 2 protocol packets with a new Layer 2 header and send them across the service-provider network. Core switches in the network do not process these packets but forward them as normal packets. Layer 2 protocol packets pass the service-provider infrastructure and reach customer switches on the outbound side of the service-provider network. The new Layer 2 header will be stripped when the Layer 2 protocol packets are sent to customer switches. Layer 2 protocol tunneling can be used independently or can enhance 802.1Q tunneling.

Principle Description

N/A

3.14.2 Configuration

Tunnel Designed Layer2 Protocol Packets

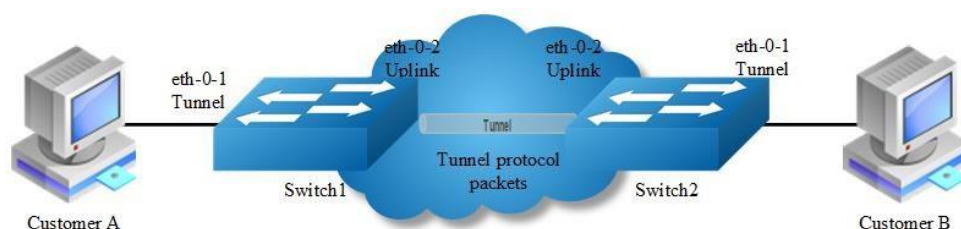

Figure 3-24 L2 protocol tunnel

The designed Layer2 protocol packets include STP BPDU, LACP slow proto, DOT1X EAPOL, CFM.

In this example, one link is between Switch1 and Switch2. Switch1 eth-0-1 and Switch2 eth-0-1 are configured tunnel port. Switch1 eth-0-2 and Switch2 eth-0-2 are configured uplink port. If protocol packets are received on port eth-0-1 of Switch1, packets should be added new Layer 2 header and sent out from uplink port. The new Layer 2 header will be as follows: MAC da should be tunnel dmac; MAC sa should be switch route-mac; VLAN ID should be tunnel vid; VLAN priority (cos) should be Layer 2 Protocol cos; Ethertype should be 0xFFEE. When the packets with new Layer 2 header are received on port eth-0-2 of Switch2, new Layer 2 header will be stripped and the packets will be sent to port eth-0-1 of Switch2.

step 1 Enter the configure mode

```
Switch# configure terminal
```

step 2 Enter the vlan configure mode and create vlan

```
Switch(config)# vlan database
Switch(config-vlan)# vlan 2-4
Switch(config-vlan)# exit
```

step 3 Create evc and set dot1q mapped vlan

```
Switch(config)# ethernet evc evc_c1
Switch(config-evc)# dot1q mapped-vlan 2
Switch(config-evc)# exit

Switch(config)# ethernet evc evc_c2
Switch(config-evc)# dot1q mapped-vlan 3
Switch(config-evc)# exit

Switch(config)# ethernet evc evc_c3
Switch(config-evc)# dot1q mapped-vlan 4
Switch(config-evc)# exit
```

step 4 Enable l2 protocol , set the tunnel destination mac and add l2 protocol mac address

```
Switch(config)# l2protocol enable
Switch(config)# l2protocol tunnel-dmac 0100.0CCD.CDD2
Switch(config)# l2protocol mac 3 0180.C200.0008
Switch(config)# l2protocol mac 4 0180.C200.0009
Switch(config)# l2protocol full-mac 0100.0CCC.CCCC
```

step 5 Enter the interface configure mode and set the attributes of the interfaces. Bind the l2 protocol mac and the evc

```
Switch(config)# interface eth-0-1
Switch(config-if)# no shutdown
Switch(config-if)# switchport mode trunk
Switch(config-if)# switchport trunk allowed vlan add 2-4
Switch(config-if)# spanning-tree port disable
Switch(config-if)# l2protocol mac 3 tunnel evc evc_c1
Switch(config-if)# l2protocol mac 4 tunnel evc evc_c2
Switch(config-if)# l2protocol full-mac tunnel evc evc_c3
Switch(config)# interface eth-0-2
Switch(config-if)# no shutdown
Switch(config-if)# switchport mode trunk
Switch(config-if)# switchport trunk allowed vlan add 2-4
Switch(config-if)# l2protocol uplink enable
```

step 6 Exit the configure mode

```
Switch(config-if)# end
```

step 7 Validation

Use the following command to display the information of tunnel interface:

```
switch1# show l2protocol interface eth-0-1
```

Interface	PDU Address	MASK	Status	EVC
	(u)-Untagged			
	(t)-Tagged			
=====	=====	=====	=====	=====
eth-0-1	0180.c200.0008 (u)	ffff.ffff.ffff	Tunnel	evc_c1
eth-0-1	0180.c200.0008 (t)	ffff.ffff.ffff	Tunnel	evc_c1
eth-0-1	0180.c200.0009 (u)	ffff.ffff.ffff	Tunnel	evc_c2
eth-0-1	0180.c200.0009 (t)	ffff.ffff.ffff	Tunnel	evc_c2
eth-0-1	0100.0ccc.cccc (u)	ffff.ffff.ffff	Tunnel	evc_c3
eth-0-1	0100.0ccc.cccc (t)	ffff.ffff.ffff	Tunnel	evc_c3
eth-0-1	stp (u)	ffff.ffff.ffff	Peer	N/A
eth-0-1	stp (t)	ffff.ffff.ffff	Peer	N/A
eth-0-1	slow-proto (u)	ffff.ffff.ffff	Peer	N/A
eth-0-1	slow-proto (t)	ffff.ffff.ffff	Peer	N/A
eth-0-1	dot1x (u)	ffff.ffff.ffff	Peer	N/A
eth-0-1	dot1x (t)	ffff.ffff.ffff	Peer	N/A
eth-0-1	cfm (u)	ffff.ffff.ffff	Peer	N/A
eth-0-1	cfm (t)	ffff.ffff.ffff	Peer	N/A
eth-0-1	lldp (u)	ffff.ffff.ffff	Peer	N/A
eth-0-1	lldp (t)	ffff.ffff.ffff	Peer	N/A
eth-0-1	cdp (u)	ffff.ffff.ffff	Peer	N/A
eth-0-1	cdp (t)	ffff.ffff.ffff	Peer	N/A
eth-0-1	vtp (u)	ffff.ffff.ffff	Peer	N/A
eth-0-1	vtp (t)	ffff.ffff.ffff	Peer	N/A

Use the following command to display the information of uplink interface:

```
switch1# show l2protocol interface eth-0-2
```

Interface	PDU Address	MASK	Status	EVC
	(u)-Untagged			
	(t)-Tagged			
=====	=====	=====	=====	=====
eth-0-2	0180.c200.0008 (u)	ffff.ffff.ffff	Peer	N/A
eth-0-2	0180.c200.0008 (t)	ffff.ffff.ffff	Peer	N/A
eth-0-2	0180.c200.0009 (u)	ffff.ffff.ffff	Peer	N/A
eth-0-2	0180.c200.0009 (t)	ffff.ffff.ffff	Peer	N/A
eth-0-2	0100.0ccc.cccc (u)	ffff.ffff.ffff	Peer	N/A
eth-0-2	0100.0ccc.cccc (t)	ffff.ffff.ffff	Peer	N/A
eth-0-2	stp (u)	ffff.ffff.ffff	Peer	N/A
eth-0-2	stp (t)	ffff.ffff.ffff	Peer	N/A
eth-0-2	slow-proto (u)	ffff.ffff.ffff	Peer	N/A
eth-0-2	slow-proto (t)	ffff.ffff.ffff	Peer	N/A
eth-0-2	dot1x (u)	ffff.ffff.ffff	Peer	N/A
eth-0-2	dot1x (t)	ffff.ffff.ffff	Peer	N/A
eth-0-2	cfm (u)	ffff.ffff.ffff	Peer	N/A
eth-0-2	cfm (t)	ffff.ffff.ffff	Peer	N/A
eth-0-2	lldp (u)	ffff.ffff.ffff	Peer	N/A
eth-0-2	lldp (t)	ffff.ffff.ffff	Peer	N/A
eth-0-2	cdp (u)	ffff.ffff.ffff	Peer	N/A
eth-0-2	cdp (t)	ffff.ffff.ffff	Peer	N/A
eth-0-2	vtp (u)	ffff.ffff.ffff	Peer	N/A
eth-0-2	vtp (t)	ffff.ffff.ffff	Peer	N/A
eth-0-2	N/A	N/A	Uplink	N/A

Use the following command to display the information of tunnel destination mac:

```
Switch1# show l2protocol tunnel-dmac
Layer2 protocols tunnel destination MAC address is 0100.0ccd.cdd2
```

3.14.3 Application cases

N/A

3.15 Configuring MSTP

3.15.1 Overview

Function Introduction

The MSTP (Multiple Spanning Tree Algorithm and Protocol (IEEE 802.1Q-2005)) enables multiple VLANs to be mapped to the same spanning-tree instance, thereby reducing the number of spanning-tree instances needed to support a large number of VLANs. The MSTP provides for multiple forwarding paths for data traffic and enables load balancing. It improves the fault tolerance of the network because a

failure in one instance (forwarding path) does not affect other instances (forwarding paths). The most common initial deployment of MSTP is in the backbone and distribution layers of a Layer 2 switched network; this deployment provides the highly-available network required in a service-provider environment. When the switch is in the multiple spanning-tree (MST) modes, the Rapid Spanning Tree Protocol (RSTP), which is based on IEEE 802.1w, is automatically enabled. The RSTP provides rapid convergence of the spanning tree through explicit handshaking that eliminates the IEEE 802.1D forwarding delay and quickly transitions root ports and designated ports to the forwarding state.

Principle Description

N/A

3.15.2 Configuration

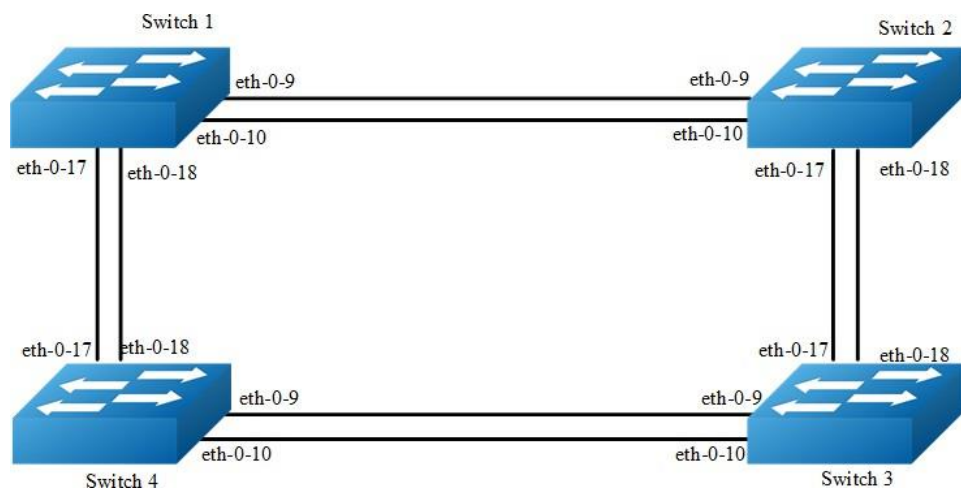

Figure 3-25 MSTP

The configurations of Switch1-Switch4 are as blow. The configurations of these 4 Switches are same if there is no special description.

step 1 Enter the configure mode

```
Switch# configure terminal
```

step 2 Set the mode of STP

```
Switch (config)# spanning-tree mode mstp
```

step 3 Enter the vlan configure mode and create vlan

```
Switch(config)# vlan database
Switch(config-vlan)# vlan 10
Switch(config-vlan)# vlan 20
Switch(config-vlan)# exit
```

step 4 Enter the MSTP configure mode , create region and instance. Bind the vlan to the instance.

```
Switch(config)# spanning-tree mst configuration
Switch(config-mst)# region RegionName
Switch(config-mst)# instance 1 vlan 10
Switch(config-mst)# instance 2 vlan 20
Switch(config-mst)# exit
```

step 5 Enter the interface configure mode, set the attributes of the interfaces

```
Switch(config)# interface eth-0-9
Switch(config-if)# switchport mode trunk
Switch(config-if)# switchport trunk allowed vlan all
Switch(config-if)# no shutdown
Switch(config-if)# exit

Switch(config)# interface eth-0-10
Switch(config-if)# switchport mode trunk
Switch(config-if)# switchport trunk allowed vlan all
Switch(config-if)# no shutdown
Switch(config-if)# exit

Switch(config)# interface eth-0-17
Switch(config-if)# switchport mode trunk
Switch(config-if)# switchport trunk allowed vlan all
Switch(config-if)# no shutdown
Switch(config-if)# exit

Switch(config)# interface eth-0-18
Switch(config-if)# switchport mode trunk
Switch(config-if)# switchport trunk allowed vlan all
Switch(config-if)# no shutdown
Switch(config-if)# exit
```

step 6 Enable STP and set priority for each swith

Switch1:

```
Switch# configure terminal
Switch(config)# spanning-tree priority 0
Switch(config)# spanning-tree enable
```

Switch2:

```
Switch# configure terminal
Switch(config)# spanning-tree instance 1 priority 0
Switch(config)# spanning-tree enable
```

Switch3:

```
Switch# configure terminal
Switch(config)# spanning-tree instance 2 priority 0
Switch(config)# spanning-tree enable
```

Switch4:

```
Switch# configure terminal
Switch(config)# spanning-tree enable
```

step 7 Exit the configure mode

```
Switch(config)# end
```

step 8 Validation

Use the following command to display the information of MSTP on Switch1:

```
Switch# show spanning-tree mst brief
##### MST0: Vlans: 1
Multiple spanning tree protocol Enabled
Root ID      Priority      0 (0x0000)
              Address      2225.fa28.c900
              Hello Time  2 sec Max Age 20 sec Forward Delay 15 sec
Bridge ID    Priority      0 (0x0000)
              Address      2225.fa28.c900
              Hello Time  2 sec Max Age 20 sec Forward Delay 15 sec
              Aging Time 300 sec
Interface    Role          State          Cost          Priority.Number  Type
-----
eth-0-9      Designated   Forwarding     20000          128.9            P2p
eth-0-10     Designated   Forwarding     20000          128.10           P2p
eth-0-17     Designated   Forwarding     20000          128.17           P2p
eth-0-18     Designated   Forwarding     20000          128.18           P2p
##### MST1: Vlans: 10
Root ID      Priority      1 (0x0001)
              Address      9c9a.7d91.9f00
Bridge ID    Priority      32769 (0x8001)
              Address      2225.fa28.c900
Interface    Role          State          Cost          Priority.Number  Type
-----
eth-0-9      Rootport     Forwarding     20000          128.9            P2p
eth-0-10     Alternate    Discarding     20000          128.10           P2p
eth-0-17     Designated   Forwarding     20000          128.17           P2p
eth-0-18     Designated   Forwarding     20000          128.18           P2p
##### MST2: Vlans: 20
Root ID      Priority      2 (0x0002)
              Address      304c.275b.b200
Bridge ID    Priority      32770 (0x8002)
```

Interface	Address	2225.fa28.c900	Cost	Priority.Number	Type
Interface	Role	State	Cost	Priority.Number	Type
eth-0-9	Alternate	Discarding	20000	128.9	P2p
eth-0-10	Alternate	Discarding	20000	128.10	P2p
eth-0-17	Rootport	Forwarding	20000	128.17	P2p
eth-0-18	Alternate	Discarding	20000	128.18	P2p

Use the following command to display the information of MSTP on Switch2:

```
Switch# show spanning-tree mst brief
##### MST0: Vlans: 1
Multiple spanning tree protocol Enabled
Root ID      Priority      0 (0x0000)
             Address      2225.fa28.c900
             Hello Time 2 sec Max Age 20 sec Forward Delay 15 sec
Bridge ID    Priority      32768 (0x8000)
             Address      9c9a.7d91.9f00
             Hello Time 2 sec Max Age 20 sec Forward Delay 15 sec
             Aging Time 300 sec
Interface    Role          State          Cost          Priority.Number  Type
-----
eth-0-9      Rootport     Forwarding     20000         128.9           P2p
eth-0-10     Alternate    Discarding     20000         128.10          P2p
eth-0-17     Designated   Forwarding     20000         128.17          P2p
eth-0-18     Designated   Forwarding     20000         128.18          P2p
##### MST1: Vlans: 10
Root ID      Priority      1 (0x0001)
             Address      9c9a.7d91.9f00
Bridge ID    Priority      1 (0x0001)
             Address      9c9a.7d91.9f00
Interface    Role          State          Cost          Priority.Number  Type
-----
eth-0-9      Designated   Forwarding     20000         128.9           P2p
eth-0-10     Designated   Forwarding     20000         128.10          P2p
eth-0-17     Designated   Forwarding     20000         128.17          P2p
eth-0-18     Designated   Forwarding     20000         128.18          P2p
##### MST2: Vlans: 20
Root ID      Priority      2 (0x0002)
             Address      304c.275b.b200
Bridge ID    Priority      32770 (0x8002)
             Address      9c9a.7d91.9f00
Interface    Role          State          Cost          Priority.Number  Type
-----
eth-0-9      Designated   Forwarding     20000         128.9           P2p
eth-0-10     Designated   Forwarding     20000         128.10          P2p
eth-0-17     Rootport     Forwarding     20000         128.17          P2p
eth-0-18     Alternate    Discarding     20000         128.18          P2p
```

Use the following command to display the information of MSTP on Switch3:

```
Switch# show spanning-tree mst brief
##### MST0: Vlans: 1
Multiple spanning tree protocol Enabled
Root ID      Priority      0 (0x0000)
             Address      2225.fa28.c900
```

```

Hello Time 2 sec Max Age 20 sec Forward Delay 15 sec
Bridge ID Priority 32768 (0x8000)
Address 304c.275b.b200
Hello Time 2 sec Max Age 20 sec Forward Delay 15 sec
Aging Time 300 sec
Interface Role State Cost Priority.Number Type
-----
eth-0-9 Rootport Forwarding 20000 128.9 P2p
eth-0-10 Alternate Discarding 20000 128.10 P2p
eth-0-17 Alternate Discarding 20000 128.17 P2p
eth-0-18 Alternate Discarding 20000 128.18 P2p
##### MST1: Vlans: 10
Root ID Priority 1 (0x0001)
Address 9c9a.7d91.9f00
Bridge ID Priority 32769 (0x8001)
Address 304c.275b.b200
Interface Role State Cost Priority.Number Type
-----
eth-0-9 Designated Forwarding 20000 128.9 P2p
eth-0-10 Designated Forwarding 20000 128.10 P2p
eth-0-17 Rootport Forwarding 20000 128.17 P2p
eth-0-18 Alternate Discarding 20000 128.18 P2p
##### MST2: Vlans: 20
Root ID Priority 2 (0x0002)
Address 304c.275b.b200
Bridge ID Priority 2 (0x0002)
Address 304c.275b.b200
Interface Role State Cost Priority.Number Type
-----
eth-0-9 Designated Forwarding 20000 128.9 P2p
eth-0-10 Designated Forwarding 20000 128.10 P2p
eth-0-17 Designated Forwarding 20000 128.17 P2p
eth-0-18 Designated Forwarding 20000 128.18 P2p

```

Use the following command to display the information of MSTP on Switch4:

Switch# show spanning-tree mst brief

```

Switch# show spanning-tree mst brief
##### MST0: Vlans: 1
Multiple spanning tree protocol Enabled
Root ID Priority 0 (0x0000)
Address 2225.fa28.c900
Hello Time 2 sec Max Age 20 sec Forward Delay 15 sec
Bridge ID Priority 32768 (0x8000)
Address 80a4.be55.6400
Hello Time 2 sec Max Age 20 sec Forward Delay 15 sec
Aging Time 300 sec
Interface Role State Cost Priority.Number Type
-----
eth-0-9 Designated Forwarding 20000 128.9 P2p
eth-0-10 Designated Forwarding 20000 128.10 P2p
eth-0-17 Rootport Forwarding 20000 128.17 P2p
eth-0-18 Alternate Discarding 20000 128.18 P2p
##### MST1: Vlans: 10

```

Root ID	Priority	1 (0x0001)			
	Address	9c9a.7d91.9f00			
Bridge ID	Priority	32769 (0x8001)			
	Address	80a4.be55.6400			
Interface	Role	State	Cost	Priority.Number	Type
eth-0-9	Alternate	Discarding	20000	128.9	P2p
eth-0-10	Alternate	Discarding	20000	128.10	P2p
eth-0-17	Rootport	Forwarding	20000	128.17	P2p
eth-0-18	Alternate	Discarding	20000	128.18	P2p
##### MST2: Vlans: 20					
Root ID	Priority	2 (0x0002)			
	Address	304c.275b.b200			
Bridge ID	Priority	32770 (0x8002)			
	Address	80a4.be55.6400			
Interface	Role	State	Cost	Priority.Number	Type
eth-0-9	Rootport	Forwarding	20000	128.9	P2p
eth-0-10	Alternate	Discarding	20000	128.10	P2p
eth-0-17	Designated	Forwarding	20000	128.17	P2p
eth-0-18	Designated	Forwarding	20000	128.18	P2p

3.15.3 Application cases

N/A

3.16 Configuring MLAG

3.16.1 Overview

Function Introduction

High availability topologies typically provide redundancy protection at the expense of oversubscription by connecting top-of-rack (TOR) switches and servers to dual aggregation switches. In these topologies, Spanning Tree Protocol prevents network loops by blocking half of the links to the aggregation switches. This reduces the available bandwidth by 50%.

Deploying MLAG removes oversubscription by configuring an MLAG link between two aggregation switches to create a single logical switching instance that utilizes all connections to the switches. Interfaces on both devices participate in a distributed port channel, enabling all active paths to carry data traffic while maintaining the integrity of the Spanning Tree topology.

MLAG provides these benefits:

- Provides higher bandwidth links as network traffic increases.
- Utilizes bandwidth more efficiently with fewer uplinks blocked by STP.
- Connects to other switches and servers by static LAG or LACP without other proprietary protocols.
- Supports active-active Layer-2 redundancy

Principle Description

N/A

3.16.2 Configuration

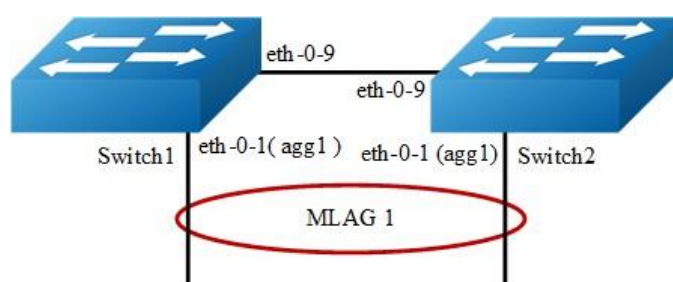

Figure 3-26 MLAG

The configurations of Switch1-Switch2 are as blow. The configurations of these 2 Switches are same if there is no special description.

step 1 Enter the configure mode

```
Switch# configure terminal
```

step 2 Enter the vlan configure mode and create vlan

```
Switch(config)# vlan database
Switch(config-vlan)# vlan 10,4094
Switch(config-vlan)# exit
```

step 3 Create a static agg

```
Switch(config)# interface eth-0-1
Switch(config-if)# static-channel-group 1
Switch(config-if)# no shutdown
Switch(config-if)# exit
```

step 4 Set the attributes of the peer link interface

interface eth-0-9 will be set as the peer link interface later

```
Switch(config)# interface eth-0-9
Switch(config-if)# switchport mode trunk
Switch(config-if)# switchport trunk allowed vlan all
Switch(config-if)# spanning-tree port disable
Switch(config-if)# no shutdown
Switch(config-if)# exit
```

step 5 Bind the agg interface to the mlag

```
Switch(config)# interface agg1
Switch(config-if)# switchport mode trunk
Switch(config-if)# switchport trunk allowed vlan add 10
Switch(config-if)# mlag 1
Switch(config-if)# exit
```

step 6 Set the attributes of the vlan interface

Switch1:

```
Switch(config)# interface vlan4094
Switch(config-if)# ip address 12.1.1.1/24
Switch(config-if)# exit
```

Switch2:

```
Switch(config)# interface vlan4094
Switch(config-if)# ip address 12.1.1.2/24
Switch(config-if)# exit
```

step 7 Enter the mlag configure mode and set the attributes of the mlag

Switch1:

```
Switch(config)# mlag configuration
Switch(config-mlag)# peer-link eth-0-9
Switch(config-mlag)# peer-address 12.1.1.2
Switch(config-mlag)# exit
```

Switch2:

```
Switch(config)# mlag configuration
Switch(config-mlag)# peer-link eth-0-9
Switch(config-mlag)# peer-address 12.1.1.1
Switch(config-mlag)# end
```

step 8 Validation

Use the following command to display the information of mlag on Switch1

```
Switch# show mlag
MLAG configuration:
-----
role          : Master
local_sysid   : ea90.aecc.cc00
mlag_sysid    : ea90.aecc.cc00
peer-link     : eth-0-9
peer conf     : Yes

Switch# show mlag interface
mlagid local-if local-state remote-state
1      aggl     up           up

Switch# show mlag peer
MLAG neighbor is 12.1.1.2, MLAG version 1
MLAG state = Established, up for 00:13:07
Last read 00:00:48, hold time is 240, keepalive interval is 60 seconds
Received 17 messages,Sent 19 messages
Open       : received 1, sent 2
KAlive     : received 15, sent 16
Fdb sync   : received 0, sent 0
Failover   : received 0, sent 0
Conf       : received 1, sent 1

Connections established 1; dropped 0
Local host: 12.1.1.1, Local port: 61000
Foreign host: 12.1.1.2, Foreign port: 46157
remote_sysid: baa7.8606.8b00

Switch# show mac address-table
          Mac Address Table
-----
(*) - Security Entry
Vlan     Mac Address      Type      Ports
-----

```

Use the following command to display the information of mac address table on Switch1

```
Switch# show mlag
MLAG configuration:
-----
role          : Slave
local_sysid   : baa7.8606.8b00
mlag_sysid    : ea90.aecc.cc00
peer-link     : eth-0-9
peer conf     : Yes
```

```

Switch# show mlag interface
mlagid local-if local-state remote-state
1 aggl up up

Switch# show mlag peer
MLAG neighbor is 12.1.1.1, MLAG version 1
MLAG state = Established, up for 00:14:29
Last read 00:00:48, hold time is 240, keepalive interval is 60 seconds
Received 19 messages,Sent 19 messages
Open : received 1, sent 1
KAlive : received 17, sent 17
Fdb sync : received 0, sent 0
Failover : received 0, sent 0
Conf : received 1, sent 1

Connections established 1; dropped 0
Local host: 12.1.1.2, Local port: 46157
Foreign host: 12.1.1.1, Foreign port: 61000
remote_sysid: ea90.aecc.cc00

```

Use the following command to display the information of mlag on Switch2:

```

Switch# show mac address-table
          Mac Address Table
-----
(*) - Security Entry
Vlan    Mac Address      Type      Ports
-----

```

3.16.3 Application cases

N/A

3.17 Configuring Hash Load-balance

3.17.1 Configuring Linkagg Hash

Overview

Linkagg can aggregate several physical interface to be a logical channel to enhance performance and redundancy. When use linkagg transmit packets, it could be cause the same data stream transmitting on different physical interfaces. Because of that, the opposite equipment can receive packet disordering. In order to avoid this phenomenon, linkagg can accord packets property to get a hash value, then it chooses appropriate physical interface to transmit packets. Besides this, it also can improve linkagg load balancing result.

Configuring Linkagg Hash Globally

The follow steps show how to set unicast and non-unicast linkagg hash on packets output interface globally and the configurations has the lowest priority.

step 1 Enter the configure mode

```
Switch# configure terminal
```

step 2 Set hash field

```
Switch(config)# hash-field user
Switch(config-hash-field)# l2 macsa
Switch(config-hash-field)# ip ipsa
Switch(config-hash-field)# exit
```

step 3 Set hash value global

```
Switch(config)# hash-value global
Switch(config-hash-value-global)# port-channel select user
Switch(config-hash-value-global)# end
```

step 4 Validation

Use the following command to display the information of hash field user:

```
Switch# show hash-field user
hash-field name: user
Option                               Control type
-----
ipv6 address compress                xor
hash seed                             user set (0)
hash arithmetic                       xor
hash symmetry                         disable
ip                                     enable
ipv6                                   enable
mpls                                   enable
-----
hash field select
Packet                                HashField
-----
l2:                                   macsa
ip:                                    ipsa
ipv6:                                  ipsa          ipda
                                       l4-sourceport  l4-destport
                                       ip-protocol
gre:                                   ipsa          ipda
```

	gre-key	
vxlan:	vni outer-ipda	outer-l4-sourceport outer-ipda
nvgre:	vsid outer-ipda	outer-ipda
mpls:	top-label	2nd-label
vpws:	top-label	2nd-label
vpls(inner-l2):	inner-macda	inner-macsa
vpls(inner-l3):	inner-ipda	inner-ipda
l3vpn:	inner-ipda inner-ip-protocol inner-l4-destport	inner-ipda inner-l4-sourceport

Use the following command to display the information of hash value global:

```
Switch# show hash-value global
LBT:load balance type          LBM :load balance mode
PT :packet type                HF  :hash field
HA :hash arithmetic
hash-value global
LBT          LBM          PT          HF          HA
-----
port-channel -            all          user        xor
ecmp         -            all          ecmp        xor
ecmp         flow id    all          ecmp        xor
entropy     -            all          ecmp        xor
-----
Efd hash field select:
macsa          macda
ipsa           ipda
sourceport     destport
ip-protocol
```

Configuring Linkagg Hash Input

The follow steps show how to set unicast linkagg hash on input interface and the configuration priority is higher than output. When the hash value is applied to in the input of linkagg port, the hash value will apply to the member port of linkagg port.

step 1 Enter the configure mode

```
Switch# configure terminal
```

step 2 Set hash field

```
Switch(config)# hash-field user
Switch(config-hash-field)# l2 macsa
Switch(config-hash-field)# ip ipsa
Switch(config-hash-field)# exit
```

step 3 Set hash value

```
Switch(config)# hash-value aaa
Switch(config-hash-value)# port-channel unicast select user
Switch(config-hash-value)# exit
```

step 4 Set hash value to interface

```
Switch(config)# interface range eth-0-1 - 2
Switch(config-if-range)# no shutdown
Switch(config-if-range)# static-channel-group 1
Switch(config-if-range)# exit
Switch(config)# interface agg 1
Switch(config-if)# load-balance hash-value aaa input
Switch(config-if)# exit
Switch(config)# interface eth-0-3
Switch(config-if)# load-balance hash-value aaa input
Switch(config-if)# end
```

step 5 Validation

Use the following command to display the information of hash field user:

```
Switch# show hash-field user
hash-field name: user
Option                               Control type
-----
ipv6 address compress                xor
hash seed                            user set (0)
hash arithmetic                      xor
hash symmetry                        disable
ip                                    enable
ipv6                                  enable
mpls                                  enable
-----
hash field select
Packet                                HashField
-----
l2:                                   macsa
ip:                                   ipsa
ipv6:                                 ipsa          ipda
                                       l4-sourceport l4-destport
                                       ip-protocol
```

```

gre:                ipsa                ipda
                   gre-key

vxlan:              vni                  outer-l4-sourceport
                   outer-ipda          outer-ipsa

nvgre:              vsid                 outer-ipda
                   outer-ipsa

mpls:               top-label            2nd-label

vpws:               top-label            2nd-label

vpls(inner-l2):    inner-macda          inner-macsa

vpls(inner-l3):    inner-ipda           inner-ipsa

l3vpn:             inner-ipsa           inner-ipda
                   inner-ip-protocol   inner-l4-sourceport
                   inner-l4-destport

```

Use the following command to display the information of hash value:

```

Switch# show hash-value aaa
LBT:load balance type          LBM:load balance mode
PT :packet type                HF :hash field
HA :hash arithmetic
hash-value name: aaa

```

LBT	LBM	PT	HF	HA
port-channel	unicast	all	user	xor
port-channel	non-unicast	all	NOCFG	NOCFG
ecmp	-	all	NOCFG	NOCFG
ecmp	flow id	all	NOCFG	NOCFG

Use the following command to display the application of hash value on port:

```

Switch# show hash-value interface-applied
eth-0-3
 hash-value aaa input
agg1
 hash-value aaa input

```

Configuring Linkagg Hash output

The follow steps show how to set unicast linkagg hash on output interface and the configuration priority is lower than input. It only can be applied on linkagg port.

step 1 Enter the configure mode

```
Switch# configure terminal
```

step 2 Set hash field

```
Switch(config)# hash-field user
Switch(config-hash-field)# l2 macsa
Switch(config-hash-field)# ip ipsa
Switch(config-hash-field)# exit
```

step 3 Set hash value

```
Switch(config)# hash-value aaa
Switch(config-hash-value)# port-channel unicast select user
Switch(config-hash-value)# exit
```

step 4 Set hash value to interface

```
Switch(config)# interface range eth-0-1 - 2
Switch(config-if-range)# no shutdown
Switch(config-if-range)# static-channel-group 1
Switch(config-if-range)# exit
Switch(config)# interface agg 1
Switch(config-if)# load-balance hash-value aaa output
Switch(config-if)# exit
```

step 5 Validation

Use the following command to display the information of hash field user:

```
Switch# show hash-field user
hash-field name: user
Option                               Control type
-----
ipv6 address compress                xor
hash seed                            user set (0)
hash arithmetic                      xor
hash symmetry                        disable
ip                                    enable
ipv6                                  enable
mpls                                  enable
-----
hash field select
Packet                                HashField
-----
l2:                                   macsa
ip:                                   ipsa
ipv6:                                 ipsa          ipda
                                       l4-sourceport l4-destport
                                       ip-protocol
gre:                                  ipsa          ipda
                                       gre-key
```

vxlan:	vni outer-ipda	outer-l4-sourceport outer-ipda
nvgre:	vsid outer-ipda	outer-ipda
mpls:	top-label	2nd-label
vpws:	top-label	2nd-label
vpls(inner-l2):	inner-macda	inner-macsa
vpls(inner-l3):	inner-ipda	inner-ipda
l3vpn:	inner-ipda inner-ip-protocol inner-l4-destport	inner-ipda inner-l4-sourceport

Use the following command to display the information of hash value:

```
Switch# show hash-value aaa
LBT:load balance type          LBM:load balance mode
PT :packet type                HF :hash field
HA :hash arithmetic
hash-value name: aaa
```

LBT	LBM	PT	HF	HA
port-channel	unicast	all	user	xor
port-channel	non-unicast	all	NOCFG	NOCFG
ecmp	-	all	NOCFG	NOCFG
ecmp	flow id	all	NOCFG	NOCFG

Use the following command to display the application of hash value on port:

```
Switch# show hash-value interface-applied
agg1
hash-value aaa output
```

Configuring Linkagg Hash ACL

The follow steps show how to make linkagg hash configurations to be a ACL action and the configurations have the highest priority.

step 1 Enter the configure mode

```
Switch# configure terminal
```

step 2 Set hash field

```
Switch(config)# hash-field user
Switch(config-hash-field)# l2 macsa
```



```
Switch(config-hash-field)# ip ipsa
Switch(config-hash-field)# exit
```

step 3 Set hash value

```
Switch(config)# hash-value aaa
Switch(config-hash-value)# port-channel unicast select user
Switch(config-hash-value)# exit
```

step 4 Add acl action to interface and set hash value to interface

```
Switch(config)# mac access-list mac
Switch(config-mac-acl)# permit src-mac host 0.0.1 dest-mac any
Switch(config-mac-acl)# exit
Switch(config)# class-map cmap1
Switch(config-cmap)# match access-group mac
Switch(config-cmap)# exit
Switch(config)# policy-map pmap1
Switch(config-pmap)# class cmap1
Switch(config-pmap-c)# load-balance hash-value aaa
Switch(config-pmap-c)# port-channel load-balance round-robin disable
Switch(config-pmap-c)# exit
Switch(config-pmap)# exit
Switch(config)# interface eth-0-3
Switch(config-if)# no shutdown
Switch(config-if)# service-policy input pmap1
Switch(config-if)# end
```

step 5 Validation

Use the following command to display the information of hash field user:

```
Switch# show hash-field user
hash-field name: user
Option                               Control type
-----
ipv6 address compress                xor
hash seed                            user set (0)
hash arithmetic                      xor
hash symmetry                        disable
ip                                    enable
ipv6                                  enable
mpls                                  enable
-----
hash field select
Packet                                HashField
-----
12:                                   macsa
ip:                                   ipsa
ipv6:                                 ipsa                                ipda
```

	l4-sourceport ip-protocol	l4-destport
gre:	ipsa gre-key	ipda
vxlan:	vni outer-ipda	outer-l4-sourceport outer-ipsa
nvgre:	vsid outer-ipsa	outer-ipda
mpls:	top-label	2nd-label
vpws:	top-label	2nd-label
vpls(inner-l2):	inner-macda	inner-macsa
vpls(inner-l3):	inner-ipda	inner-ipsa
l3vpn:	inner-ipsa inner-ip-protocol inner-l4-destport	inner-ipda inner-l4-sourceport

Use the following command to display the information of hash value:

```
Switch# show hash-value aaa
LBT:load balance type          LBM:load balance mode
PT :packet type                HF :hash field
HA :hash arithmetic
hash-value name: aaa
LBT          LBM          PT          HF          HA
-----
port-channel unicast      all          user        xor
port-channel non-unicast  all          NOCFG      NOCFG
ecmp         -                all          NOCFG      NOCFG
ecmp         flow id         all          NOCFG      NOCFG
```

Use the following command to display the information of ACL:

```
Switch# show running-config
mac access-list mac
  10 permit src-mac host 0000.0000.0001 dest-mac any
!
hash-field user
  l2 macsa
  ip ipsa
!
hash-value aaa
  port-channel unicast select user
!
class-map match-any cmap1
  match access-group mac
!
policy-map pmap1
  class cmap1
```

```
port-channel load-balance round-robin disable
load-balance hash-value aaa
!
interface eth-0-3
service-policy input pmap1
!
interface null0
!
```

Configuring Non-unicast Linkagg Hash

The follow steps show how to set non-unicast linkagg hash on input interface and the configuration does not support on output. When the hash value is applied to in the input of linkagg port, the hash value will apply to the member port of linkagg port.

step 1 Enter the configure mode

```
Switch# configure terminal
```

step 2 Set hash field

```
Switch(config)# hash-field user
Switch(config-hash-field)# l2 macsa
Switch(config-hash-field)# ip ipsa
Switch(config-hash-field)# exit
```

step 3 Set hash value

```
Switch(config)# hash-value aaa
Switch(config-hash-value)# port-channel non-unicast select user
Switch(config-hash-value)# exit
```

step 4 Set hash value to interface

```
Switch(config)# interface range eth-0-1 - 2
Switch(config-if-range)# no shutdown
Switch(config-if-range)# static-channel-group 1
Switch(config-if-range)# exit
Switch(config)# interface agg 1
Switch(config-if)# load-balance hash-value aaa input
Switch(config-if)# exit
Switch(config)# interface eth-0-3
```

```
Switch(config-if)# load-balance hash-value aaa input
Switch(config-if)# end
```

step 5 Validation

Use the following command to display the information of hash field user:

```
Switch# show hash-field user
hash-field name: user
Option                               Control type
-----
ipv6 address compress                xor
hash seed                            user set (0)
hash arithmetic                       xor
hash symmetry                         disable
ip                                     enable
ipv6                                   enable
mpls                                   enable
-----
hash field select
Packet                                HashField
-----
l2:                                   macsa
ip:                                   ipsa
ipv6:                                 ipsa          ipda
                                       l4-sourceport l4-destport
                                       ip-protocol
gre:                                  ipsa          ipda
                                       gre-key
vxlan:                                vni           outer-l4-sourceport
                                       outer-ipda    outer-ipsa
nvgre:                                vsid          outer-ipda
                                       outer-ipsa
mpls:                                  top-label     2nd-label
vpws:                                  top-label     2nd-label
vpls(inner-l2):                       inner-macda   inner-macsa
vpls(inner-l3):                       inner-ipda    inner-ipsa
l3vpn:                                inner-ipsa    inner-ipda
                                       inner-ip-protocol inner-l4-sourceport
                                       inner-l4-destport
```

Use the following command to display the information of hash value:

```
Switch# show hash-value aaa
LBT:load balance type          LBM:load balance mode
```

```
PT :packet type          HF :hash field
HA :hash arithmetic
hash-value name: aaa
LBT          LBM          PT          HF          HA
-----
```

LBT	LBM	PT	HF	HA
port-channel	unicast	all	NOCFG	NOCFG
port-channel	non-unicast	all	user	xor
ecmp	-	all	NOCFG	NOCFG
ecmp	flow id	all	NOCFG	NOCFG

Use the following command to display the application of hash value on port:

Use the following command to display the application of hash value on port:

```
Switch# show hash-value interface-applied
eth-0-3
  hash-value aaa input
agg1
  hash-value aaa input
```

3.17.2 Configuring ECMP Hash

Overview

Equal-cost multi-path routing is a routing strategy where next-hop packet forwarding to a single destination can occur over multiple “best paths” which tie for top place in routing metric calculations. Multi-path routing can be used in conjunction with

most routing protocols, because it is a per-hop decision limited to a single router. It can substantially increase bandwidth by load-balancing traffic over multiple paths. ECMP hash is used to do load balance.

Configuring ECMP Hash Globally

The following steps show how to set ECMP hash globally and the configurations have the lowest priority.

step 1 Enter the configure mode

```
Switch# configure terminal
```

step 2 Set hash field

```
Switch(config)# hash-field user
Switch(config-hash-field)# l2 macsa
Switch(config-hash-field)# ip ipsa
Switch(config-hash-field)# exit
```

step 3 Set hash value global

```
Switch(config)# hash-value global
Switch(config-hash-value-global)# ecmp select user
Switch(config-hash-value-global)# end
```

step 4 Validation

Use the following command to display the information of hash field user:

```
Switch# show hash-field user
hash-field name: user
Option                               Control type
-----
ipv6 address compress                xor
hash seed                             user set (0)
hash arithmetic                       xor
hash symmetry                         disable
ip                                     enable
ipv6                                   enable
mpls                                   enable
-----
hash field select
Packet                                HashField
-----
l2:                                   macsa
ip:                                   ipsa
```

ipv6:	ipsa l4-sourceport ip-protocol	ipda l4-destport
gre:	ipsa gre-key	ipda
vxlan:	vni outer-ipda	outer-l4-sourceport outer-ipsa
nvgre:	vsid outer-ipsa	outer-ipda
mpls:	top-label	2nd-label
vpws:	top-label	2nd-label
vpls(inner-l2):	inner-macda	inner-macsa
vpls(inner-l3):	inner-ipda	inner-ipsa
l3vpn:	inner-ipsa inner-ip-protocol inner-l4-destport	inner-ipda inner-l4-sourceport

Use the following command to display the information of hash value global:

```
Switch# show hash-value global
LBT:load balance type          LBM :load balance mode
PT :packet type                HF  :hash field
HA :hash arithmetic
hash-value global
LBT          LBM          PT          HF          HA
-----
port-channel -          all          port-channel xor
ecmp         -          all          user         xor
ecmp         flow id    all          user         xor
entropy      -          all          ecmp         xor
-----
Efd hash field select:
macsa        macda
ipsa         ipda
sourceport   destport
ip-protocol
```

Configuring ECMP Hash Input

The follow steps show how to set ECMP hash on input interface and the configuration priority is higher than global configuration.

step 1 Enter the configure mode

```
Switch# configure terminal
```

step 2 Set hash field

```
Switch(config)# hash-field user
Switch(config-hash-field)# l2 macsa
Switch(config-hash-field)# ip ipsa
Switch(config-hash-field)# exit
```

step 3 Set hash value

```
Switch(config)# hash-value bbb
Switch(config-hash-value)# ecmp select user
Switch(config-hash-value)# exit
```

step 4 Set hash value to interface

```
Switch(config)# interface eth-0-1
Switch(config-if)# no shutdown
Switch(config-if)# load-balance hash-value bbb input
Switch(config-if)# end
```

step 5 Validation

Use the following command to display the information of hash field user:

```
Switch# show hash-field user
hash-field name: user
Option                               Control type
-----
ipv6 address compress                 xor
hash seed                             user set (0)
hash arithmetic                       xor
hash symmetry                         disable
ip                                     enable
ipv6                                   enable
mpls                                   enable
-----
hash field select
Packet                                HashField
-----
l2:                                   macsa
ip:                                   ipsa
ipv6:                                  ipsa          ipda
                                       l4-sourceport 14-destport
                                       ip-protocol
```

gre:	ipsa gre-key	ipda
vxlan:	vni outer-ipda	outer-l4-sourceport outer-ipsa
nvgre:	vsid outer-ipsa	outer-ipda
mpls:	top-label	2nd-label
vpws:	top-label	2nd-label
vpls(inner-l2):	inner-macda	inner-macsa
vpls(inner-l3):	inner-ipda	inner-ipsa
l3vpn:	inner-ipsa inner-ip-protocol inner-l4-destport	inner-ipda inner-l4-sourceport

Use the following command to display the information of hash value:

```
Switch# show hash-value bbb
LBT:load balance type          LBM:load balance mode
PT :packet type                HF :hash field
HA :hash arithmetic
hash-value name: bbb
LBT          LBM          PT          HF          HA
-----
port-channel unicast      all          NOCFG      NOCFG
port-channel non-unicast all          NOCFG      NOCFG
ecmp         -              all          user        xor
ecmp         flow id      all          NOCFG      NOCFG
```

Use the following command to display the application of hash value on port:

```
Switch# show hash-value interface-applied
eth-0-1
hash-value bbb input
```

Configuring ECMP Hash input

The follow steps show how to make ECMP hash configurations to be a ACL action and the configurations have the highest priority.

step 1 Enter the configure mode

```
Switch# configure terminal
```

step 2 Set hash field

```
Switch(config)# hash-field user
Switch(config-hash-field)# 12 macsa
Switch(config-hash-field)# ip ipsa
Switch(config-hash-field)# exit
```

step 3 Set hash value

```
Switch(config)# hash-value bbb
Switch(config-hash-value)# ecmp select user
Switch(config-hash-value)# exit
```

step 4 Add acl action to interface and set hash value to interface

```
Switch(config)# mac access-list mac
Switch(config-mac-acl)# permit src-mac host 0.0.1 dest-mac any
Switch(config-mac-acl)# exit
Switch(config)# class-map cmap1
Switch(config-cmap)# match access-group mac
Switch(config-cmap)# exit
Switch(config)# policy-map pmap1
Switch(config-pmap)# class cmap1
Switch(config-pmap-c)# load-balance hash-value bbb
Switch(config-pmap-c)# ecmp load-balance round-robin disable
Switch(config-pmap-c)# exit
Switch(config-pmap)# exit
Switch(config)# interface eth-0-1
Switch(config-if)# no shutdown
Switch(config-if)# service-policy input pmap1
Switch(config-if)# end
```

step 5 Validation

Use the following command to display the information of hash field user:

```
Switch# show hash-field user
hash-field name: user
Option                               Control type
-----
ipv6 address compress                xor
hash seed                            user set (0)
hash arithmetic                      xor
hash symmetry                        disable
ip                                    enable
ipv6                                  enable
mpls                                  enable
-----
hash field select
Packet                                HashField
-----
12:                                   macsa
```

ip:	ipsa	
ipv6:	ipsa	ipda
	l4-sourceport	l4-destport
	ip-protocol	
gre:	ipsa	ipda
	gre-key	
vxlan:	vni	outer-l4-sourceport
	outer-ipda	outer-ipsa
nvgre:	vsid	outer-ipda
	outer-ipsa	
mpls:	top-label	2nd-label
vpws:	top-label	2nd-label
vpls(inner-l2):	inner-macda	inner-macsa
vpls(inner-l3):	inner-ipda	inner-ipsa
l3vpn:	inner-ipsa	inner-ipda
	inner-ip-protocol	inner-l4-sourceport
	inner-l4-destport	

Use the following command to display the information of hash value:

```
Switch# show hash-value bbb
LBT:load balance type          LBM:load balance mode
PT :packet type                HF :hash field
HA :hash arithmetic
hash-value name: bbb
LBT          LBM          PT          HF          HA
-----
port-channel unicast      all          NOCFG      NOCFG
port-channel non-unicast all          NOCFG      NOCFG
ecmp         -              all          user        xor
ecmp         flow id      all          NOCFG      NOCFG
```

Use the following command to display the information of ACL:

```
mac access-list mac
 10 permit src-mac host 0000.0000.0001 dest-mac any
!
hash-field user
 12 macsa
 ip ipsa
!
hash-value bbb
 ecmp select user
!
class-map match-any cmap1
 match access-group mac
```

```

!
policy-map pmap1
  class cmap1
    ecmp load-balance round-robin disable
    load-balance hash-value bbb
!
interface eth-0-1
  service-policy input pmap1
!
interface null0
!

```

3.17.3 Configuring ECMP Hash

Overview

Elephant Flow Detect(EFD). According to the academic institutions of the actual network of the study found that more than 80% of the bandwidth is occupied by elephant flow, the bandwidth and transmission cache of these flow is large, but not sensitive to delay, which is sensitive to delay The flow caused a great impact.EFD hash is used to detect elephant flow by recognising packet features.

Configuring EFD Hash Globally

The follow steps show how to select packet features for EFD hash globally.

step 1 Enter the configure mode

```
Switch# configure terminal
```

step 2 Set hash global

```
Switch(config)# hash-value global
Switch(config-hash-value-global)# efd select ipsa macsa
Switch(config-hash-value-global)# end
```

step 3 Validation

Use the following command to display the information of hash value global:

```
Switch# show hash-value global
LBT:load balance type          LBM :load balance mode
PT :packet type                HF :hash field
HA :hash arithmetic
hash-value global
LBT          LBM          PT          HF          HA
```

port-channel	-	all	port-channel	xor
ecmp	-	all	ecmp	xor
ecmp	flow id	all	ecmp	xor
entropy	-	all	ecmp	xor
Efd hash field select:				
macsa		ipsa		

3.18 Configuring PORT-XCONNECT

3.18.1 Overview

Function Introduction

This feature can forward the packet directly according to the destination-interface configured without looking up any table items and forwarding.

Only physical and aggregate port are currently supported.

Principle Description

N/A

3.18.2 Configuration

step 1 Enter the configure mode

```
Switch# configure terminal
```

step 2 Enter the interface mode and no shutdown

```
Switch(config)# interface range eth-0-1 , eth-0-2
Switch(config-if-range)# no shutdown
```

step 3 Set eth-0-1 port-xconnect destination interface

```
Switch(config)# interface eth-0-1
Switch(config-if)# port-xconnect destination-interface eth-0-2
Switch(config-if)# end
```

step 4 Display configuration

```
Switch# show running-config
Building configuration...
version 5.3.9.18
!
no service password-encryption
!
!
!
!
!
!
!
temperature 0 0 0
!
vlan database
!

interface eth-0-1
port-xconnect destination-interface eth-0-2
!
interface eth-0-2
!
interface eth-0-3
Switch#
```

3.18.3 Application cases

N/A

4 IP Service Configuration Guide

4.1 Configuring Arp

4.1.1 Overview

Function Introduction

The Address Resolution Protocol (ARP) is a protocol used to dynamically map between Internet host addresses and Ethernet addresses. ARP caches Internet-Ethernet address mappings. When an interface requests a mapping for an address not in the cache, ARP queues the message, which requires the mapping, and broadcasts a message on the associated network requesting the address mapping. If a response is provided, the new mapping is cached and any pending message is transmitted. ARP will queue at most one packet while waiting for a response to a mapping request; only the most recently transmitted packet is kept. If the target host does not respond after 3 requests, the host is considered to be down, allowing an error to be returned to transmission attempts during this interval. If a target host does not send message for a period (normally one hour), the host is considered to be uncertainty, and several requests (normally 6, 3 unicast and 3 broadcast) will send to the host before delete the ARP entry. ARP entries may be added, deleted or changed manually. Manually added entries may be temporary or permanent.

Principle Description

N/A

4.1.2 Configuration

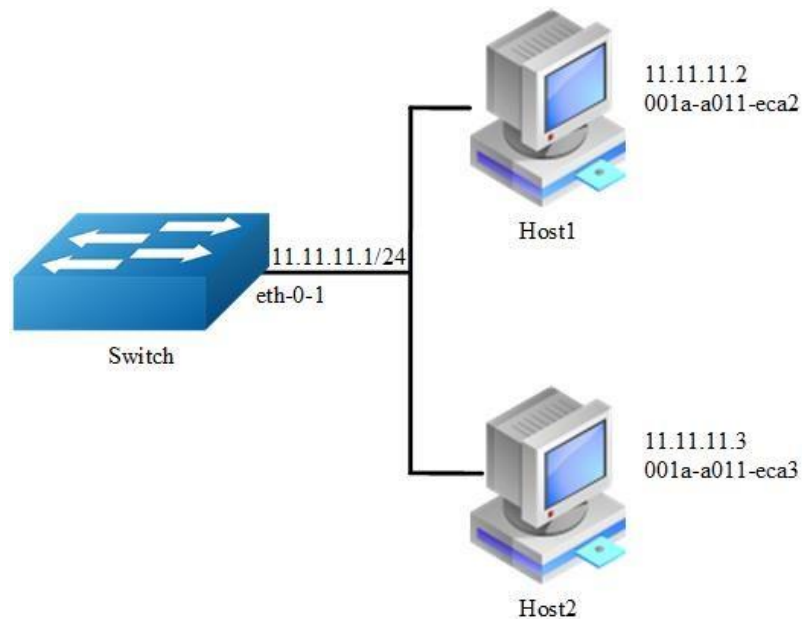

Figure 4-1 arp

In this configuration example, interface eth-0-1 assigned with address 11.11.11.1/24, on subnet 11.11.11.0/24, there are two hosts, and their IP addresses are 11.11.11.2, 11.11.11.3, MAC address are 001a-a011-eca2, 001a-a011-eca3. ARP entry of host 11.11.11.2 is added manually, the entry of host 11.11.11.3 is added dynamically. Time-out period of ARP entries for interface eth-0-1 configure to 20 minutes, ARP request retry delay on interface eth-0-1 configure to 2 seconds.

step 1 Enter the configure mode

```
Switch# configure terminal
```

step 2 Configure the layer 3 interface and set the ip address

```
Switch(config)# interface eth-0-1
Switch(config-if)# no switchport
Switch(config-if)# ip address 11.11.11.1/24
```

step 3 Configure arp aging timeout value and the arp retry interval value

```
Switch(config-if)# arp timeout 1200
Switch(config-if)# arp retry-interval 2
Switch(config-if)# exit
```

step 4 Add a static arp entry

```
Switch(config)# arp 11.11.11.2 1a.a011.eca2
```

step 5 Exit the configure mode

```
Switch(config)# end
```

step 6 Validation

Use the following command to display the information of the arp entry:

```
Switch# show ip arp
Protocol      Address          Age (min)  Hardware Addr  Interface
Internet     11.11.11.2      -         001a.a011.eca2 eth-0-1

Switch# show ip arp summary
1 IP ARP entries, with 0 of them incomplete
(Static:0, Dyamic:0, Interface:1)
ARP Pkt Received is: 0
ARP Pkt Send number is: 0
ARP Pkt Dicard number is: 0
```

Use the following command to display the information of the arp configurations on the interface:

```
Switch# show interface eth-0-1
Interface eth-0-1
  Interface current state: Administratively DOWN
  Hardware is Ethernet, address is 6c02.530c.2300 (bia 6c02.530c.2300)
  Bandwidth 1000000 kbits
  Index 1 , Metric 1 , Encapsulation ARPA
  Speed - Auto , Duplex - Auto , Media type is 1000BASE_T
  Link speed type is autonegotiation, Link duplex type is autonegotiation
  Input flow-control is off, output flow-control is off
  The Maximum Frame Size is 1534 bytes
  VRF binding: not bound
  Label switching is disabled
  No virtual circuit configured
  VRRP master of : VRRP is not configured on this interface
  ARP timeout 00:20:00, ARP retry interval 2s
  5 minute input rate 0 bits/sec, 0 packets/sec
  5 minute output rate 0 bits/sec, 0 packets/sec
    0 packets input, 0 bytes
  Received 0 unicast, 0 broadcast, 0 multicast
    0 runts, 0 giants, 0 input errors, 0 CRC
    0 frame, 0 overrun, 0 pause input
    0 input packets with dribble condition detected
    0 packets output, 0 bytes
  Transmitted 0 unicast, 0 broadcast, 0 multicast
  0 underruns, 0 output errors, 0 pause output
```

4.1.3 Application cases

N/A

4.2 Configuring Arp proxy

4.2.1 Overview

Function Introduction

Proxy ARP, the most common method for learning about other routes, enables an Ethernet host with no routing information to communicate with hosts on other networks or subnets. The host assumes that all hosts are on the same local Ethernet and that they can use ARP to determine their MAC addresses. If a switch receives an ARP request for a host that is not on the same network as the sender, the switch evaluates whether it has the best route to that host. If it does, it sends an ARP reply packet with its own Ethernet MAC address, and the host that sent the request sends the packet to the switch, which forwards it to the intended host. Proxy ARP treats all networks as if they are local and performs ARP requests for every IP address. Proxy ARP can be separated to 2 parts: Proxy ARP and local Proxy ARP. Local Proxy ARP is always used in the topology where the Device is enabled port isolate but still need to do communicating via routing. Internet Control Message Protocol (ICMP) redirects are disabled on interfaces where the local proxy ARP feature is enabled.

Principle Description

N/A

4.2.2 Configuration

Configuring ARP Proxy

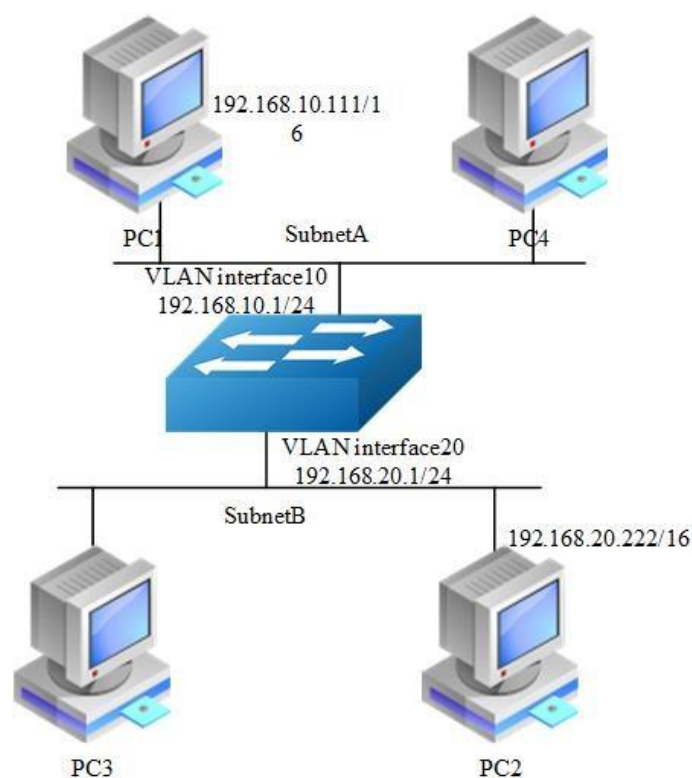

Figure 4-2 arp proxy

As seen in the above topology, PC1 is belonged to VLAN10 and PC2 is belonged to VLAN20. If ARP proxy feature is not enabled, then PC1 and PC2 can not communicate with each other. As following, these steps are shown to enable ARP proxy feature for both VLAN interface 10 and VLAN interface 20.

step 1 Enter the configure mode

```
Switch# configure terminal
```

step 2 Enter the vlan configure mode and create vlan

```
Switch(config)# vlan database  
Switch(config-vlan)# vlan 10,20  
Switch(config-vlan)# exit
```

step 3 Enter the interface configure mode, set the switch port mode and bind to the vlan

```
Switch(config)# interface eth-0-22
Switch(config-if)# switchport access vlan 10
Switch(config-if)# no shutdown
Switch(config-if)# exit

Switch(config)# interface eth-0-23
Switch(config-if)# switchport access vlan 20
Switch(config-if)# no shutdown
Switch(config-if)# exit
```

step 4 Create the vlan interface, configure the ip address, and enable arp proxy

```
Switch(config)# interface vlan 10
Switch(config-if)# ip address 192.168.10.1/24
Switch(config-if)# proxy-arp enable
Switch(config-if)# exit

Switch(config)# interface vlan 20
Switch(config-if)# ip address 192.168.20.1/24
Switch(config-if)# proxy-arp enable
Switch(config-if)# exit
```

step 5 Exit the configure mode

```
Switch(config)# end
```

step 6 Validation

Use the following command to display the information of the arp proxy configuration on the switch:

```
Switch# show ip interface vlan 10
Interface vlan10
  Interface current state: UP
  Internet address(es):
    192.168.10.1/24 broadcast 192.168.10.255
  Joined group address(es):
    224.0.0.1
  The maximum transmit unit is 1500 bytes
  ICMP error messages limited to one every 1000 milliseconds
  ICMP redirects are always sent
  ICMP unreachable are always sent
  ICMP mask replies are always sent
  ARP timeout 01:00:00, ARP retry interval 1s
  ARP Proxy is enabled, Local ARP Proxy is disabled
  VRRP master of : VRRP is not configured on this interface

Switch# show ip interface vlan 20
```

```

Interface vlan20
  Interface current state: UP
  Internet address(es):
    192.168.20.1/24 broadcast 192.168.20.255
  Joined group address(es):
    224.0.0.1
  The maximum transmit unit is 1500 bytes
  ICMP error messages limited to one every 1000 milliseconds
  ICMP redirects are always sent
  ICMP unreachable are always sent
  ICMP mask replies are always sent
  ARP timeout 01:00:00, ARP retry interval 1s
  ARP Proxy is enabled, Local ARP Proxy is disabled
  VRRP master of : VRRP is not configured on this interface

```

Use the following command to display the information of the arp entry on the switch:

```

Switch# show ip arp

```

Protocol	Address	Age (min)	Hardware Addr	Interface
Internet	192.168.10.1	-	7cc3.11f1.aa00	vlan10
Internet	192.168.10.111	5	0cf9.11b6.6e2e	vlan10
Internet	192.168.20.1	-	7cc3.11f1.aa00	vlan20
Internet	192.168.20.222	6	5a94.031f.2357	vlan20

Use the following command to display the information on PC1:

```

[Host:~]$ ifconfig eth0
eth0      Link encap:Ethernet  HWaddr 0C:F9:11:B6:6E:2E
          inet addr:192.168.10.111 Bcast:192.168.255.255 Mask:255.255.0.0
          UP BROADCAST RUNNING MULTICAST MTU:1600 Metric:1
          RX packets:11 errors:0 dropped:0 overruns:0 frame:0
          TX packets:10 errors:0 dropped:0 overruns:0 carrier:0
          collisions:0 txqueuelen:1000
          RX bytes:588 (588.0 b) TX bytes:700 (700.0 b)
          Interrupt:5

[Host:~]$ arp -a
? (192.168.20.222) at 7c:c3:11:f1:aa:00 [ether] on eth0
[Host: ~]$ route -v
Kernel IP routing table
Destination Gateway Genmask Flags Metric Ref Use Iface
192.168.0.0 * 255.255.0.0 U 0 0 0 eth0

[Host:~]$ ping 192.168.20.222
PING 192.168.20.222 (192.168.20.222) 56(84) bytes of data.
64 bytes from 192.168.20.222: icmp_seq=0 ttl=63 time=189 ms
64 bytes from 192.168.20.222: icmp_seq=1 ttl=63 time=65.2 ms
--- 192.168.20.222 ping statistics ---
2 packets transmitted, 2 received, 0% packet loss, time 1000ms
rtt min/avg/max/mdev = 65.209/127.226/189.244/62.018 ms, pipe 2

```

Use the following command to display the information on PC2:

```

[Host:~]$ ifconfig eth0
eth0      Link encap:Ethernet  HWaddr 5A:94:03:1F:23:57
          inet addr:192.168.20.222 Bcast:192.168.255.255 Mask:255.255.0.0

```

```

UP BROADCAST RUNNING MULTICAST  MTU:1600  Metric:1
RX packets:14 errors:0 dropped:0 overruns:0 frame:0
TX packets:17 errors:0 dropped:0 overruns:0 carrier:0
collisions:0 txqueuelen:1000
RX bytes:784 (784.0 b)  TX bytes:1174 (1.1 KiB)
Interrupt:5

[Host:~]$ arp -a
? (192.168.10.111) at 7c:c3:11:f1:aa:00 [ether] on eth0

[Host: ~]$ route -v
Kernel IP routing table
Destination      Gateway          Genmask         Flags Metric Ref    Use Iface
192.168.0.0      *               255.255.0.0    U        0      0      0 eth0

[Host: ~]$ ping 192.168.10.111
PING 192.168.10.111 (192.168.10.111) 56(84) bytes of data.
64 bytes from 192.168.10.111: icmp_seq=0 ttl=63 time=53.8 ms
64 bytes from 192.168.10.111: icmp_seq=1 ttl=63 time=65.8 ms
--- 192.168.10.111 ping statistics ---
2 packets transmitted, 2 received, 0% packet loss, time 1007ms
rtt min/avg/max/mdev = 53.832/59.842/65.852/6.010 ms, pipe 2

```

Configuring Local ARP Proxy

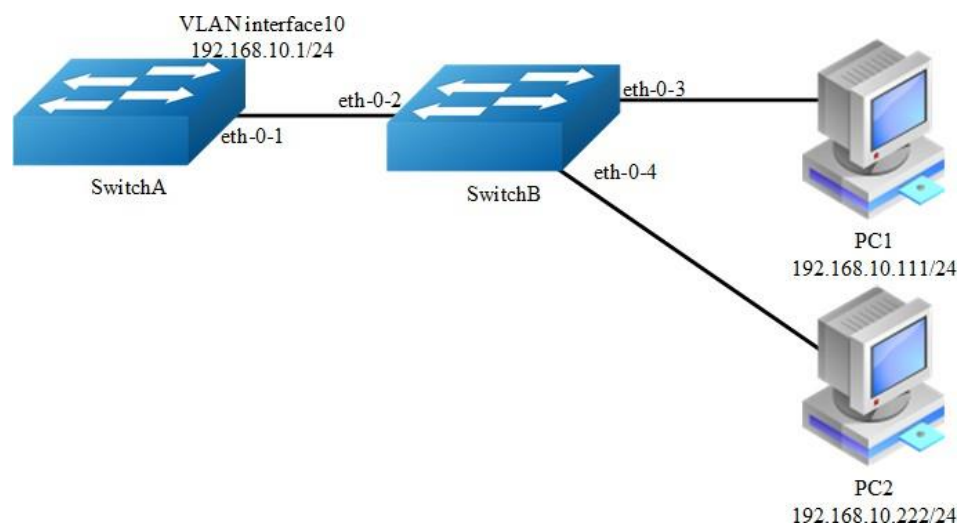

Figure 4-3 local arp proxy

As the above topology, eth-0-2, eth-0-3 and eth-0-4 are belonging to VLAN 10. eth-0-3 and eth-0-4 are both in port isolate group 1, and eth-0-2 is in port isolate group 3, so packets received in eth-0-3 can not flood to eth-0-4, but packets received in eth-0-2 can flood to both eth-0-3 and eth-0-4. PC1 is connecting with port eth-0-3 and PC2 is connecting with port eth-0-4. Configure as the following step for communicating with PC1 and PC2.

The configurations of switch A and switch B are same if there is no special description.

step 1 Enter the configure mode

```
Switch# configure terminal
```

step 2 Enter the vlan configure mode and create vlan

```
Switch(config)# vlan database  
Switch(config-vlan)# vlan 10  
Switch(config-vlan)# exit
```

step 3 Enter the interface configure mode, set the switch port mode and bind to the vlan

Switch A configuration:

```
Switch(config)# interface eth-0-1  
Switch(config-if)# switchport access vlan 10  
Switch(config-if)# no shutdown  
Switch(config-if)# exit
```

Switch B configuration:

```
Switch(config)# interface range eth-0-2 - 4  
Switch(config-if-range)# switchport access vlan 10  
Switch(config-if-range)# no shutdown  
Switch(config-if-range)# exit
```

step 4 Create the vlan interface, configure the ip address, and enable local arp proxy

Switch A configuration:

```
Switch(config)# interface vlan 10  
Switch(config-if)# ip address 192.168.10.1/24  
Switch(config-if)# local-proxy-arp enable  
Switch(config-if)# exit
```

step 5 Configuring port isolation(optional)

Switch B configuration:

After configuring port isolation as blow, eth-0-3 and eth-0-4 on swichB are isolated in layer 2 network.

```
Switch(config)# port-isolate mode l2  
Switch(config)# interface eth-0-3 - 4
```

```
Switch(config-if-range)# port-isolate group 1
Switch(config-if-range)# exit

Switch(config)# interface eth-0-2
Switch(config-if)# port-isolate group 3
Switch(config-if)# exit
```

step 6 Validation

Use the following command to display the information of the arp entry on switchA:

```
Switch# show ip arp
Protocol      Address          Age (min)  Hardware Addr  Interface
Internet     192.168.10.1    -         eeb4.2a8d.6c00  vlan10
Internet     192.168.10.111  0         34b0.b279.5f67  vlan10
Internet     192.168.10.222  0         2a65.9618.57fa  vlan10
```

Use the following command to display the information of the arp configurations on the interface of switchA:

```
Switch# show ip interface vlan 10
Interface vlan10
  Interface current state: UP
  Internet address(es):
    192.168.10.1/24 broadcast 192.168.10.255
  Joined group address(es):
    224.0.0.1
  The maximum transmit unit is 1500 bytes
  ICMP error messages limited to one every 1000 milliseconds
  ICMP redirects are never sent
  ICMP unreachable are always sent
  ICMP mask replies are always sent
  ARP timeout 01:00:00, ARP retry interval 1s
  ARP Proxy is disabled, Local ARP Proxy is enabled
  VRRP master of : VRRP is not configured on this interface
```

Use the following command to display the information on PC1:

```
[Host: ~]$ ifconfig eth0
eth0      Link encap:Ethernet  HWaddr 34:B0:B2:79:5F:67
          inet addr:192.168.10.111 Bcast:192.168.10.255 Mask:255.255.255.0
          UP BROADCAST RUNNING MULTICAST MTU:1600 Metric:1
          RX packets:22 errors:0 dropped:0 overruns:0 frame:0
          TX packets:28 errors:0 dropped:0 overruns:0 carrier:0
          collisions:0 txqueuelen:1000
          RX bytes:1344 (1.3 KiB) TX bytes:2240 (2.1 KiB)
          Interrupt:5

[Host: ~]$ arp -a
? (192.168.10.222) at ee:b4:2a:8d:6c:00 [ether] on eth0

[Host: ~]$ ping 192.168.10.222
PING 192.168.10.222 (192.168.10.222) 56(84) bytes of data.
64 bytes from 192.168.10.222: icmp_seq=0 ttl=63 time=131 ms
```



```
64 bytes from 192.168.10.222: icmp_seq=1 ttl=63 time=159 ms
--- 192.168.10.222 ping statistics ---
2 packets transmitted, 2 received, 0% packet loss, time 1003ms
rtt min/avg/max/mdev = 131.078/145.266/159.454/14.188 ms, pipe 2
```

Use the following command to display the information on PC2:

```
[Host:~]$ ifconfig eth0
eth0      Link encap:Ethernet  HWaddr 2A:65:96:18:57:FA
          inet addr:192.168.10.222 Bcast:192.168.10.255 Mask:255.255.255.0
          UP BROADCAST RUNNING MULTICAST  MTU:1600 Metric:1
          RX packets:19 errors:0 dropped:0 overruns:0 frame:0
          TX packets:20 errors:0 dropped:0 overruns:0 carrier:0
          collisions:0 txqueuelen:1000
          RX bytes:1148 (1.1 KiB)  TX bytes:1524 (1.4 KiB)
          Interrupt:5

[Host:~]$ arp -a
? (192.168.10.111) at ee:b4:2a:8d:6c:00 [ether] on eth0

[Host: ~]$ ping 192.168.10.111
PING 192.168.10.111 (192.168.10.111) 56(84) bytes of data.
64 bytes from 192.168.10.111: icmp_seq=0 ttl=63 time=198 ms
64 bytes from 192.168.10.111: icmp_seq=1 ttl=63 time=140 ms
64 bytes from 192.168.10.111: icmp_seq=2 ttl=63 time=146 ms
--- 192.168.10.111 ping statistics ---
3 packets transmitted, 3 received, 0% packet loss, time 2008ms
rtt min/avg/max/mdev = 140.196/161.959/198.912/26.267 ms, pipe 2
```

4.2.3 Application cases

N/A

4.3 Configuring DHCP Client

4.3.1 Overview

Function Introduction

Dynamic Host Configuration Protocol(DHCP) client can acquire IP address and configuration dynamically from DHCP server by DHCP. If client and server is on the same physical subnet, client can communicate with server directly, otherwise they need DHCP relay agent which is used to forward DHCP messages. DHCP client can request IP address from DHCP server by broadcasting DHCP messages. After received IP address and lease correspond to it, client will configure itself and set the expired time. When half past the lease, client will sent DHCP messages for a new lease to

use the IP address continually. If it success, DHCP client will renew the lease. DHCP client can send option request to server, which may be one or several of router, static-route, classless-static-route, classless-static-route-ms, tftp-server-address, dns-nameserver , domain-name, netbios-nameserver and vendor-specific. By default, options include router, static-route, classless-static-route, classless-static-route-ms, tftp-server-address will be requested from server. We can cancel one or several of these option requests by command.

Principle Description

N/A

4.3.2 Configuration

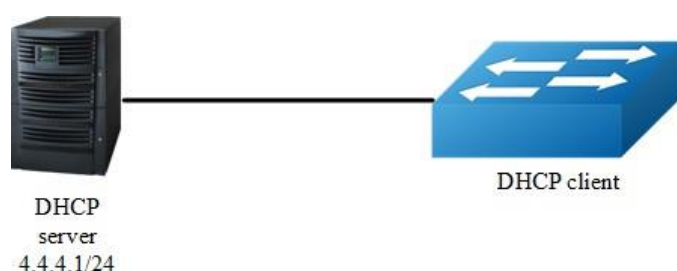

Figure 4-4 dhcp client

step 1 Enter the configure mode

```
Switch# configure terminal
```

step 2 Enter the interface configure mode

```
Switch(config)# interface eth-0-1  
Switch(config-if)# no switchport  
Switch(config-if)# no shutdown
```

step 3 disable static-route and enable DHCP client

```
Switch(config-if)# no dhcp client request static-route  
Switch(config-if)# ip address dhcp
```

step 4 Exit the configure mode

```
Switch(config-if)# end
```

step 5 Validation

Check interface configuration:

```
Switch# show running-config interface eth-0-1
Building configuration...
!
interface eth-0-1
  no switchport
  ip address dhcp
  no dhcp client request static-route
!
```

Check all DHCP client status:

```
Switch# show dhcp client verbose
DHCP client informations:
=====
eth-0-1 DHCP client information:
  Current state: BOUND
  Allocated IP: 4.4.4.199 255.255.255.0
  Lease/renewal/rebinding: 1187/517/1037 seconds
  Lease from 2011-11-18 05:59:59 to 2011-11-18 06:19:59
  Will Renewal in 0 days 0 hours 8 minutes 37 seconds
  DHCP server: 4.4.4.1
  Transaction ID: 0x68857f54
  Client ID: switch-7e39.3457.b700-eth-0-1
```

Show DHCP client statistics:

```
Switch# show dhcp client statistics
DHCP client packet statistics:
=====
DHCP OFFERS    received: 1
DHCP ACKs      received: 2
DHCP NAKs      received: 0
DHCP Others    received: 0
DHCP DISCOVER  sent: 1
DHCP DECLINE   sent: 0
DHCP RELEASE   sent: 0
DHCP REQUEST   sent: 2
DHCP packet send failed: 0
```

4.3.3 Application cases

N/A

4.4 Configuring DHCP Relay

4.4.1 Overview

Function Introduction

DHCP relay agent is any host that forwards DHCP packets between clients and servers. Relay agents are used to forward requests and replies between clients and servers when they are not on the same physical subnet. Relay agent forwarding is distinct from the normal forwarding of an IP router, where IP datagram are switched between networks somewhat transparently. By contrast, relay agents receive DHCP messages and then generate a new DHCP message to send out on another interface. The relay agent sets the gateway address (girder field of the DHCP packet) and, if configured, adds the relay agent information option (option82) in the packet and forwards it to the DHCP server. The reply from the server is forwarded back to the client after removing option 82.

Principle Description

N/A

4.4.2 Configuration

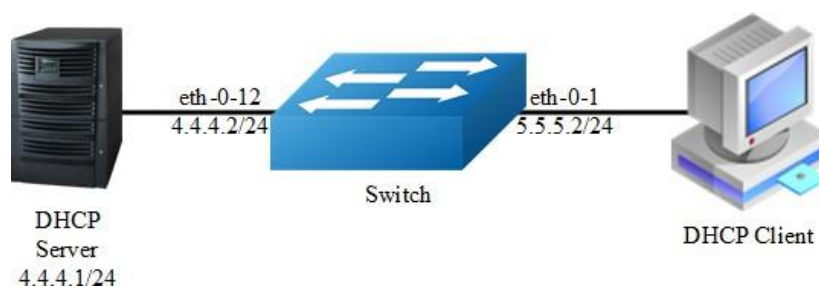

Figure 4-5 DHCP relay

This figure is the networking topology for testing DHCP relay functions. We need two Linux boxes and one Switch to construct the test bed.

Computer A is used as DHCP server.

Computer B is used as DHCP client.

Switch is used as DHCP relay agent.

step 1 Enter the configure mode

```
Switch# configure terminal
```

step 2 Enter the interface configure mode , set the attributes and ip address

```
Switch(config)# interface eth-0-12
Switch(config-if)# no switchport
Switch(config-if)# ip address 4.4.4.2/24
Switch(config-if)# no shutdown
Switch(config-if)# exit
```

```
Switch(config)# interface eth-0-1
Switch(config-if)# no switchport
Switch(config-if)# ip address 5.5.5.2/24
Switch(config-if)# no shutdown
Switch(config-if)# exit
```

step 3 Create a dhcp server

```
Switch(config)# dhcp-server 1 4.4.4.1
```

step 4 Enable DHCP server and option82 for the interface

```
Switch(config)# interface eth-0-1
Switch(config-if)# dhcp relay information trusted
Switch(config-if)# dhcp-server 1
Switch(config-if)# exit
```

step 5 Enable DHCP server and DHCP relay globally

```
Switch(config)# service dhcp enable
Switch(config)# dhcp relay
```

step 6 Validation

Check the interface configuration

```
Switch# show running-config interface eth-0-12
!
interface eth-0-12
  no switchport
  ip address 4.4.4.2/24
!
Switch# show running-config interface eth-0-1
!
interface eth-0-1
```

```
no switchport
dhcp relay information trusted
dhcp-server 1
ip address 5.5.5.2/24
!
```

Check the dhcp service status

```
Switch# show services
Networking services configuration:
Service Name          Status
=====
dhcp                  enable
```

Check the dhcp server group configuration

```
Switch# show dhcp-server
DHCP server group information:
=====
group 1 ip address list:
[1] 4.4.4.1
```

Check the dhcp relay statistics

```
Switch# show dhcp relay statistics
DHCP relay packet statistics:
=====
Client relayed packets: 20
Server relayed packets: 20
Client error packets: 20
Server error packets: 0
Bogus GIADDR drops: 0
Bad circuit ID packets: 0
Corrupted agent options: 0
Missing agent options: 0
Missing circuit IDs: 0
```

Check your computer ip address from DHCP server

```
Ipconfig /all
Dhcp Enabled. . . . . : Yes
Autoconfiguration Enabled . . . . : Yes
IP Address. . . . . : 5.5.5.1
Subnet Mask . . . . . : 255.255.255.0
Default Gateway . . . . . : 5.5.5.2
DHCP Server . . . . . : 4.4.4.1
DNS Servers . . . . . : 4.4.4.1
```

4.4.3 Application cases

N/A

4.5 Configuring DHCP server

4.5.1 Overview

Function Introduction

A DHCP server is an Internet host that returns configuration parameters to DHCP clients . DHCP server can provide IP address and network configuration for DHCP client by DHCP. For provide DHCP service, DHCP server need to be configured first. For example, IP address pool need be create , default gateway should be set in a pool, and some network parameters for DHCP client should be set before DHCP working. After DHCP server start to work, it will find a valid IP address from pool for DHCP client when receiving client's request. Meantime it also send network configuration parameters to client. The IP address assigned by DHCP server have a period of validity(lease), so DHCP client need to renew its lease before the lease expired for reserving current IP address by sending DHCP REQUEST message.

If DHCP server was in the same subnet with client,it can normal work after connect to subnet. Otherwise DHCP relay was needed for server providing DHCP service ,which can help to forward DHCP message between server and client.

Main options supported by DHCP server include bootfile-name, dns-server, domain-name, gateway, netbios-name-server, netbios-node-type, tftp-server-address. Besides these, some raw options were also be supported ,which were set with option code.

Principle Description

N/A

4.5.2 Configuration

Configuring DHCP server



Figure 4-6 DHCP server

step 1 Enter the configure mode

```
Switch# configure terminal
```

step 2 Enable DHCP server globally , configure the ip address pool

Configure on DUT1:

```
Switch(config)#service dhcp enable
Switch(config)#dhcp server
Switch(config)#dhcp pool pool5
Switch(dhcp-config)#network 5.5.5.0/24
Switch(dhcp-config)#gateway 5.5.5.1
Switch(dhcp-config)#exit
```

step 3 Enter the interface configure mode , set the attributes and ip address

Configure on DUT1:

```
Switch(config)#interface eth-0-9
Switch (config-if)#no switchport
Switch (config-if)# no shutdown
Switch (config-if)# ip address 5.5.5.1/24
Switch (config-if)# dhcp server enable
Switch (config-if)#exit
```

Configure on DUT2:

```
Switch#configure terminal
Switch(config)#interface eth-0-9
Switch (config-if)#no switchport
Switch (config-if)# no shutdown
Switch (config-if)# ip address dhcp
Switch (config-if)#exit
```

step 4 Validation

Check DHCP Server(dut1) configuration:

```
Switch# show running-config
!
service dhcp enable
!
interface eth-0-9
  no switchport
  dhcp server enable
  ip address 5.5.5.1/24!
!
dhcp server
dhcp pool pool5
  network 5.5.5.0/24
  gateway 5.5.5.1
```

Check DHCP client status on DHCP Client(dut2):

```
Switch# show dhcp client verbose
DHCP client informations:
=====
eth-0-9 DHCP client information:
  Current state: BOUND
  Allocated IP: 5.5.5.2 255.255.255.0
  Lease/renewal/rebinding: 1194/546/1044 seconds
  Lease from 2012-02-04 07:40:12 to 2012-02-04 08:00:12
  Will Renewal in 0 days 0 hours 9 minutes 6 seconds
  DHCP server: 5.5.5.1
  Transaction ID: 0x45b0b27b
  Default router: 5.5.5.1
  Classless static route:
    Destination: 5.5.4.0, mask: 255.255.255.0, Nexthop: 5.5.5.1
  TFTP server addresses: 5.5.5.3
Client ID: switch-6e6e.361f.8400-eth-0-9
```

Check DHCP server statistics on DHCP Server(dut1):

```
Switch# show dhcp server statistics
DHCP server packet statistics:
=====
Message Received:
BOOTREQUEST: 0
DHCPDISCOVER: 1
DHCPREQUEST: 1
DHCPDECLINE: 0
DHCPRELEASE: 0
DHCPINFORM: 0
Message Sent:
BOOTREPLY: 0
DHCPOFFER: 1
DHCPACK: 1
DHCPNAK: 0
```

Check DHCP server addresses and interfaces on DHCP Server(dut1):

```
Switch# show dhcp server binding all
IP address      Client-ID/      Lease expiration      Type
                Hardware address
5.5.5.2         6e:6e:36:1f:84:00  Sat 2012.02.04 08:00:12  Dynamic
Switch# show dhcp server interfaces
List of DHCP server enabled interface(s):
DHCP server service status: enabled
Interface Name
=====
eth-0-9
```

Configuring DHCP server with relay



Figure 4-7 DHCP relay

step 1 Enter the configure mode

```
Switch# configure terminal
```

step 2 Enable DHCP server globally , configure the ip address pool and DHCP relay

Configure on DUT1:

```
Switch(config)#service dhcp enable
Switch(config)#dhcp server
Switch(dhcp-config)#dhcp pool pool4
Switch(dhcp-config)#network 4.4.4.0/24
Switch(dhcp-config)#gateway 4.4.4.1
Switch(dhcp-config)#exit
```

Configure on DUT2:

```
Switch(config)#service dhcp enable
Switch(config)#dhcp relay
Switch(config)#dhcp-server 1 5.5.5.1
```

step 2 Add a ip route

Configure on DUT1:

```
Switch(config)#ip route 4.4.4.0/24 5.5.5.2
```

step 4 Enter the interface configure mode , set the attributes and ip address

Configure on DUT1:

```
Switch(config)#interface eth-0-9
Switch (config-if)#no switchport
Switch (config-if)# no shutdown
Switch (config-if)# ip address 5.5.5.1/24
Switch (config-if)# dhcp server enable
Switch (config-if)#exit
```

Configure on DUT2:

```
Switch(config)#interface eth-0-17
Switch (config-if)#no switchport
Switch (config-if)# no shutdown
Switch (config-if)# ip address 4.4.4.1/24
Switch (config-if)# dhcp-server 1
```

```
Switch (config-if)#interface eth-0-9
Switch (config-if)#no switchport
Switch (config-if)# no shutdown
Switch (config-if)# ip address 5.5.5.2/24
Switch (config-if)#exit
```

Configure on DUT3:

```
Switch(config)#interface eth-0-17
Switch (config-if)#no switchport
Switch (config-if)# no shutdown
Switch (config-if)# ip address dhcp
Switch (config-if)#exit
```

step 5 Exit the configure mode

```
Switch(config)# end
```

step 6 Validation

Check DHCP Server(dut1) configuration:

```
Switch# show running-config
!
service dhcp enable
!
interface eth-0-9
 no switchport
 dhcp server enable
 ip address 5.5.5.1/24!
!
```

```
ip route 4.4.4.0/24 5.5.5.2
!
dhcp server
dhcp pool pool4
  network 4.4.4.0/24
  gateway 4.4.4.1
```

Check DHCP client status on DHCP Server(dut1):

```
Switch# show dhcp client verbose
DHCP client informations:
=====
eth-0-17 DHCP client information:
  Current state: BOUND
  Allocated IP: 4.4.4.5 255.255.255.0
  Lease/renewal/rebinding: 1199/517/1049 seconds
  Lease from 2012-02-06 05:23:09 to 2012-02-06 05:43:09
  Will Renewal in 0 days 0 hours 8 minutes 37 seconds
  DHCP server: 5.5.5.1
  Transaction ID: 0x192a4f7d
  Default router: 4.4.4.1
  Classless static route:
    Destination: 5.5.4.0, mask: 255.255.255.0, Nexthop: 4.4.4.1
  TFTP server addresses: 5.5.5.3
  Client ID: switch-3c9a.b29a.ba00-eth-0-17
```

Check DHCP server statistics on DHCP Server(dut1):

```
Switch# show dhcp server statistics
DHCP server packet statistics:
=====
Message Received:
BOOTREQUEST: 0
DHCPCDISCOVER: 1
DHCPCREQUEST: 1
DHCPCDECLINE: 0
DHCPCRELEASE: 0
DHCPCINFORM: 0
Message Sent:
BOOTREPLY: 0
DHCPCOFFER: 1
DHCPCACK: 1
DHCPCNAK: 0
```

Check DHCP server addresses and interfaces on DHCP Server(dut1):

```
Switch# show dhcp server binding all
IP address      Client-ID/      Lease expiration      Type
                Hardware address
4.4.4.5         3c:9a:b2:9a:ba:00  Mon 2012.02.06 05:43:09  Dynamic
Switch# show dhcp server interfaces
List of DHCP server enabled interface(s):
DHCP server service status: enabled
Interface Name
=====
eth-0-9
```

4.5.3 Application cases

N/A

4.6 Configuring DNS

4.6.1 Overview

Function Introduction

The DNS protocol controls the Domain Name System (DNS), a distributed database with which you can map hostnames to IP addresses. When you configure DNS on your switch, you can substitute the hostname for the IP address with all IP commands, such as ping, telnet, connect, and related Telnet support operations. IP defines a hierarchical naming scheme that allows a device to be identified by its location or domain. Domain names are pieced together with periods (.) as the delimiting characters. To keep track of domain names, IP has defined the concept of a domain name server, which holds a cache (or database) of names mapped to IP addresses. To map domain names to IP addresses, you must first identify the hostnames, specify the name server that is present on your network, and enable the DNS.

Principle Description

N/A

4.6.2 Configuration

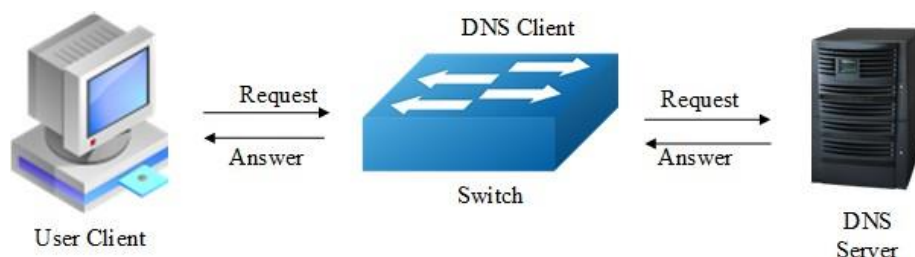

Figure 4-8 DNS

step 1 Enter the configure mode

```
Switch# configure terminal
```

step 2 Set the dns domain name and dns server address

```
Switch(config)#dns domain server1  
Switch(config)#dns server 202.100.10.20
```

step 3 Set static hostname-to-address mappings (optional)

```
Switch(config)# ip host www.example1.com 192.0.2.141
```

step 4 Validation

```
Switch# show dns server  
Current DNS name server configuration:  
      Server                IP Address  
-----  
1    nameserver            202.100.10.20
```

4.6.3 Application cases

N/A

5 IP Routing Configuration Guide

5.1 Configuring IP Unicast-Routing

5.1.1 Overview

Function Introduction

Static routing is a concept describing one way of configuring path selection of routers in computer networks. It is the type of routing characterized by the absence of communication between routers regarding the current topology of the network. This is achieved by manually adding routes to the routing table. The opposite of static routing is dynamic routing, sometimes also referred to as adaptive routing.

In these systems, routes through a data network are described by fixed paths (statically). These routes are usually entered into the router by the system administrator. An entire network can be configured using static routes, but this type of configuration is not fault tolerant. When there is a change in the network or a failure occurs between two statically defined nodes, traffic will not be rerouted. This means that anything that wishes to take an affected path will either have to wait for the failure to be repaired or the static route to be updated by the administrator before restarting its journey. Most requests will time out (ultimately failing) before these repairs can be made. There are, however, times when static routes can improve the performance of a network. Some of these include stub networks and default routes.

Principle Description

N/A

5.1.2 Configuration

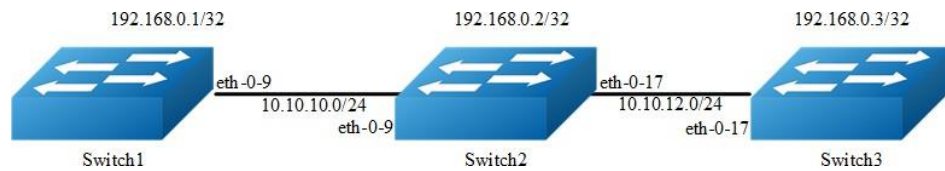

Figure 5-1 ip unicast routing

This example shows how to enable static route in a simple network topology.

There are 3 static routes on Switch1, one is to achieve remote network 10.10.12.0/24, the other two are to achieve the loopback addresses on Switch2 and Switch3. There is a default static route on Switch3, that is, static routes use same gateway or nexthop address. There are 2 static routes on switchc2, both of them are to achieve the remote switch's loopback address.

step 1 Enter the configure mode

```
Switch# configure terminal
```

step 2 Enter the interface configure mode , set the attributes and ip address

Configure on Switch1:

```
Switch(config)# interface eth-0-9
Switch(config-if)# no shutdown
Switch(config-if)# no switchport
Switch(config-if)# ip address 10.10.10.1/24
Switch(config-if)# exit

Switch(config)# interface loopback 0
Switch(config-if)# ip address 192.168.0.1/32
Switch(config-if)# exit
```

Configure on Switch2:

```
Switch(config)# interface eth-0-9
Switch(config-if)# no shutdown
Switch(config-if)# no switchport
Switch(config-if)# ip address 10.10.10.2/24
Switch(config-if)# exit

Switch(config)# interface eth-0-17
Switch(config-if)# no shutdown
Switch(config-if)# no switchport
Switch(config-if)# ip address 10.10.12.2/24
```



```
Switch(config-if)# exit

Switch(config)# interface loopback 0
Switch(config-if)# ip address 192.168.0.2/32
Switch(config-if)# exit
```

Configure on Switch3:

```
Switch(config)# interface eth-0-17
Switch(config-if)# no shutdown
Switch(config-if)# no switchport
Switch(config-if)# ip address 10.10.12.3/24
Switch(config-if)# exit

Switch(config)# interface loopback 0
Switch(config-if)# ip add 192.168.0.3/32
Switch(config-if)# exit
```

step 3 Configuring static route

Configure on Switch1:

Note:Specify the destination prefix and mask for the network for which a gateway is required, for example, 10.10.12.0/24. Add a gateway for each of them (in this case 10.10.10.2 for all). Since R2 is the only next hop available, you can configure a default route instead of configuring the same static route for individual addresses.

```
Switch(config)# ip route 10.10.12.0/24 10.10.10.2
Switch(config)# ip route 192.168.0.2/32 10.10.10.2
Switch(config)# ip route 192.168.0.3/32 10.10.10.2
```

Configure on Switch2:

```
Switch(config)# ip route 192.168.0.1/32 10.10.10.1
Switch(config)# ip route 192.168.0.3/32 10.10.12.3
```

Configure on Switch3:

Note:Specify 10.10.12.2 as a default gateway to reach any network. Since 10.10.12.2 is the only route available you can specify it as the default gateway instead of specifying it as the gateway for individual network or host addresses.

```
Switch(config)# ip route 0.0.0.0/0 10.10.12.2
```

step 4 Exit the configure mode

```
Switch(config)# end
```

step 5 Validation

Use the following command to display the route information on Switch1:

```
Switch# show ip route
Codes: K - kernel, C - connected, S - static, R - RIP, B - BGP
       O - OSPF, IA - OSPF inter area
       N1 - OSPF NSSA external type 1, N2 - OSPF NSSA external type 2
       E1 - OSPF external type 1, E2 - OSPF external type 2
       i - IS-IS, L1 - IS-IS level-1, L2 - IS-IS level-2, ia - IS-IS inter area
       [*] - [AD/Metric]
       * - candidate default
C      10.10.10.0/24 is directly connected, eth-0-9
C      10.10.10.1/32 is in local loopback, eth-0-9
S      10.10.12.0/24 [1/0] via 10.10.10.2, eth-0-9
C      192.168.0.1/32 is directly connected, loopback0
S      192.168.0.2/32 [1/0] via 10.10.10.2, eth-0-9
S      192.168.0.3/32 [1/0] via 10.10.10.2, eth-0-9
```

Use the following command to display the route information on Switch2:

```
Switch# show ip route
Codes: K - kernel, C - connected, S - static, R - RIP, B - BGP
       O - OSPF, IA - OSPF inter area
       N1 - OSPF NSSA external type 1, N2 - OSPF NSSA external type 2
       E1 - OSPF external type 1, E2 - OSPF external type 2
       i - IS-IS, L1 - IS-IS level-1, L2 - IS-IS level-2, ia - IS-IS inter area
       [*] - [AD/Metric]
       * - candidate default
C      10.10.10.0/24 is directly connected, eth-0-9
C      10.10.10.2/32 is in local loopback, eth-0-9
C      10.10.12.0/24 is directly connected, eth-0-17
C      10.10.12.2/32 is in local loopback, eth-0-17
S      192.168.0.1/32 [1/0] via 10.10.10.1, eth-0-9
C      192.168.0.2/32 is directly connected, loopback0
S      192.168.0.3/32 [1/0] via 10.10.12.3, eth-0-17
```

Use the following command to display the route information on Switch3:

```
Switch# show ip route
Codes: K - kernel, C - connected, S - static, R - RIP, B - BGP
       O - OSPF, IA - OSPF inter area
       N1 - OSPF NSSA external type 1, N2 - OSPF NSSA external type 2
       E1 - OSPF external type 1, E2 - OSPF external type 2
       i - IS-IS, L1 - IS-IS level-1, L2 - IS-IS level-2, ia - IS-IS inter area
       [*] - [AD/Metric]
       * - candidate default
Gateway of last resort is 10.10.12.2 to network 0.0.0.0
S*    0.0.0.0/0 [1/0] via 10.10.12.2, eth-0-17
C      10.10.12.0/24 is directly connected, eth-0-17
C      10.10.12.3/32 is in local loopback, eth-0-17
C      192.168.0.3/32 is directly connected, loopback0
```

5.1.3 Application cases

N/A

5.2 Configuring RIP

5.2.1 Overview

Function Introduction

Routing Information Protocol (RIP) is an IP route exchange protocol that uses a distance vector (a number representing distance) to measure the cost of a given route. The cost is a distance vector because the cost is often equivalent to the number of router hops between the source and the destination networks. RIP can receive multiple paths to a destination. The system evaluates the paths, selects the best path, and saves the path in the IP route table as the route to the destination. Typically, the best path is the path with the fewest hops. A hop is another router through which packets must travel to reach the destination. If RIP receives a RIP update from another router that contains a path with fewer hops than the path stored in the route table, the system replaces the older route with the newer one. The system then includes the new path in the updates it sends to other RIP routers. RIP routers also can modify a route's cost, generally by adding to it, to bias the selection of a route for a given destination. In this case, the actual number of router hops may be the same, but the route has an administratively higher cost and is thus less likely to be used than other, lower-cost routes. A RIP route can have a maximum cost of 15. Any destination with a higher cost is considered unreachable. Although limiting to larger networks, the low maximum hop count prevents endless loops in the network.

This chapter contains basic RIP configuration examples. To see details on the commands used in these examples, or to see the outputs of the Validation commands, refer to the RIP Command Reference. To avoid repetition, some Common commands, like `configure terminal`, have not been listed under the Commands Used section.

Principle Description

Reference to RFC 2453

5.2.2 Configuration

Enabling RIP

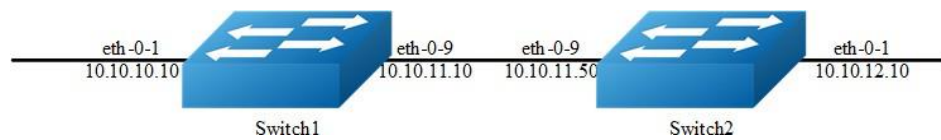

Figure 5-2 enable rip

step 1 Enter the configure mode

```
Switch# configure terminal
```

step 2 Enter the interface configure mode, set the attributes and ip address

Configure on Switch1:

```
Switch(config)# interface eth-0-1
Switch(config-if)# no switchport
Switch(config-if)# no shutdown
Switch(config-if)# ip address 10.10.10.10/24
Switch(config-if)# exit

Switch(config)# interface eth-0-9
Switch(config-if)# no switchport
Switch(config-if)# no shutdown
Switch(config-if)# ip address 10.10.11.10/24
Switch(config-if)# exit
```

Configure on Switch2:

```
Switch(config)# interface eth-0-1
Switch(config-if)# no switchport
Switch(config-if)# no shutdown
Switch(config-if)# ip address 10.10.12.10/24
Switch(config-if)# exit

Switch(config)# interface eth-0-9
Switch(config-if)# no switchport
Switch(config-if)# no shutdown
Switch(config-if)# ip address 10.10.11.50/24
Switch(config-if)# exit
```

step 3 Enable RIP routing process and associate networks

Configure on Switch1:

```
Switch(config)# router rip
Switch(config-router)#network 10.10.10.0/24
Switch(config-router)#network 10.10.11.0/24
Switch(config-router)# exit
```

Configure on Switch2:

```
Switch(config)# router rip
Switch(config-router)#network 10.10.11.0/24
Switch(config-router)#network 10.10.12.0/24
Switch(config-router)# exit
```

step 5 Exit the configure mode

```
Switch(config)# end
```

step 6 Validation

Use the following command to display the database of rip on Switch1:

```
Switch# show ip rip database
Codes: R - RIP, Rc - RIP connected, Rs - RIP static, K - Kernel,
       C - Connected, S - Static, O - OSPF, I - IS-IS, B - BGP
Network          Next Hop          Metric From          If          Time
Rc 10.10.10.0/24          1                      eth-0-1
Rc 10.10.11.0/24          1                      eth-0-9
R 10.10.12.0/24          10.10.11.50          2 10.10.11.50          eth-0-9 00: 02: 52
```

Use the following command to display the protocol state of rip process on Switch1:

```
Switch# show ip protocols rip
Routing protocol is "rip"
  Sending updates every 30 seconds with +/-5 seconds, next due in 17 seconds
  Timeout after 180 seconds, Garbage collect after 120 seconds
  Outgoing update filter list for all interface is not set
  Incoming update filter list for all interface is not set
  Default redistribution metric is 1
  Redistributing:
  Default version control:  send version 2, receive version 2
    Interface      Send      Recv      Key-chain
    eth-0-1         2         2
    eth-0-9         2         2
  Routing for Networks:
    10.10.10.0/24
    10.10.11.0/24
  Routing Information Sources:
    Gateway          Distance  Last Update  Bad Packets  Bad Routes
    10.10.11.50          120     00: 00: 22          0            0
  Number of routes (including connected):  3
  Distance:  (default is 120)
```

Use the following command to display the interface of rip on Switch1:

```
Switch# show ip rip interface
eth-0-1 is up, line protocol is up
  Routing Protocol: RIP
    Receive RIP packets
    Send RIP packets
    Passive interface: Disabled
    Split horizon: Enabled with Poisoned Reversed
    IP interface address:
      10.10.10.10/24
eth-0-9 is up, line protocol is up
  Routing Protocol: RIP
    Receive RIP packets
    Send RIP packets
    Passive interface: Disabled
    Split horizon: Enabled with Poisoned Reversed
    IP interface address:
      10.10.11.10/24
```

Use the following command to display routes on Switch1:

```
Switch# show ip route
Codes: K - kernel, C - connected, S - static, R - RIP, B - BGP
       O - OSPF, IA - OSPF inter area
       N1 - OSPF NSSA external type 1, N2 - OSPF NSSA external type 2
       E1 - OSPF external type 1, E2 - OSPF external type 2
       i - IS-IS, L1 - IS-IS level-1, L2 - IS-IS level-2, ia - IS-IS inter area
       [*] - [AD/Metric]
       * - candidate default

C       10.10.10.0/24 is directly connected, eth-0-1
C       10.10.10.10/32 is in local loopback, eth-0-1
C       10.10.11.0/24 is directly connected, eth-0-9
C       10.10.11.10/32 is in local loopback, eth-0-9
R       10.10.12.0/24 [120/2] via 10.10.11.50, eth-0-9, 00: 25: 50
```

Configuring The RIP Version



Figure 5-3 rip version

Configure the receive and send specific versions of packets on an interface .

In this example, Switch2 is configured to receive and send RIP version 1 and 2 on eth-0-9 and eth-0-20.

step 1 Enter the configure mode

The following commands operate on Switch2:

```
Switch# configure terminal
```

step 2 Enable RIP routing process

```
Switch(config)# router rip
Switch(config-router)# exit
```

step 3 Enter the interface configure mode and set the version for sending and receiving rip packets

```
Switch(config)# interface eth-0-9
Switch(config-if)# ip rip send version 1 2
Switch(config-if)# ip rip receive version 1 2
Switch(config-if)# quit

Switch(config)# interface eth-0-20
Switch(config-if)# ip rip send version 1 2
Switch(config-if)# ip rip receive version 1 2
Switch(config-if)# quit
```

step 4 Exit the configure mode

```
Switch(config)# end
```

step 5 Validation

Use the following command to display the configuration on Switch1:

```
Switch# show running-config
interface eth-0-9
  no switchport
  ip address 10.10.11.10/24
!
router rip
  network 10.10.11.0/24
```

Use the following command to display the database of rip on Switch2:

```
Switch# show ip rip database
Codes: R - RIP, Rc - RIP connected, Rs - RIP static, K - Kernel,
       C - Connected, S - Static, O - OSPF, I - IS-IS, B - BGP
   Network          Next Hop          Metric From          If          Time
R   10.0.0.0/8      1                      eth-0-9
Rc  10.10.11.0/24   1                      eth-0-9
Rc  10.10.12.0/24   1                      eth-0-20
```

Use the following command to display the protocol state of rip process on Switch2:

```
Switch# show ip protocols rip
Routing protocol is "rip"
  Sending updates every 30 seconds with +/-5 seconds, next due in 1 seconds
```

```

Timeout after 180 seconds, Garbage collect after 120 seconds
Outgoing update filter list for all interface is not set
Incoming update filter list for all interface is not set
Default redistribution metric is 1
Redistributing:
Default version control:  send version 2, receive version 2
  Interface          Send          Recv   Key-chain
  eth-0-9            1 2          1 2
  eth-0-20           1 2          1 2
Routing for Networks:
  10.10.11.0/24
  10.10.12.0/24
Routing Information Sources:
  Gateway            Distance Last Update Bad Packets Bad Routes
  10.10.11.10        120 00: 00: 22          0          0
  10.10.12.50        120 00: 00: 27          0          0
Number of routes (including connected):  3 Distance
: (default is 120)

```

Use the following command to display the interface of rip on Switch2:

```

Switch# show ip rip interface
eth-0-9 is up, line protocol is up
  Routing Protocol:  RIP
    Receive RIPv1 and RIPv2 packets
    Send RIPv1 and RIPv2 packets
    Passive interface:  Disabled
    Split horizon:  Enabled with Poisoned Reversed
    IP interface address:
      10.10.11.50/24
eth-0-20 is up, line protocol is up
  Routing Protocol:  RIP
    Receive RIPv1 and RIPv2 packets
    Send RIPv1 and RIPv2 packets
    Passive interface:  Disabled
    Split horizon:  Enabled with Poisoned Reversed
    IP interface address:
      10.10.12.10/24

```

Use the following command to display the configuration on Switch2:

```

Switch# show run
interface eth-0-9
  no switchport
  ip address 10.10.11.50/24
  ip rip send version 1 2
  ip rip receive version 1 2
!
interface eth-0-20
  no switchport
  ip address 10.10.12.10/24
  ip rip send version 1 2
  ip rip receive version 1 2
!
router rip

```



```
network 10.10.11.0/24
network 10.10.12.0/24
```

Use the following command to display the configuration on Switch3:

```
Switch# show running-config
interface eth-0-20
no switchport
ip address 10.10.12.50/24
!
router rip
network 10.10.12.0/24
```

Configuring Metric Parameters

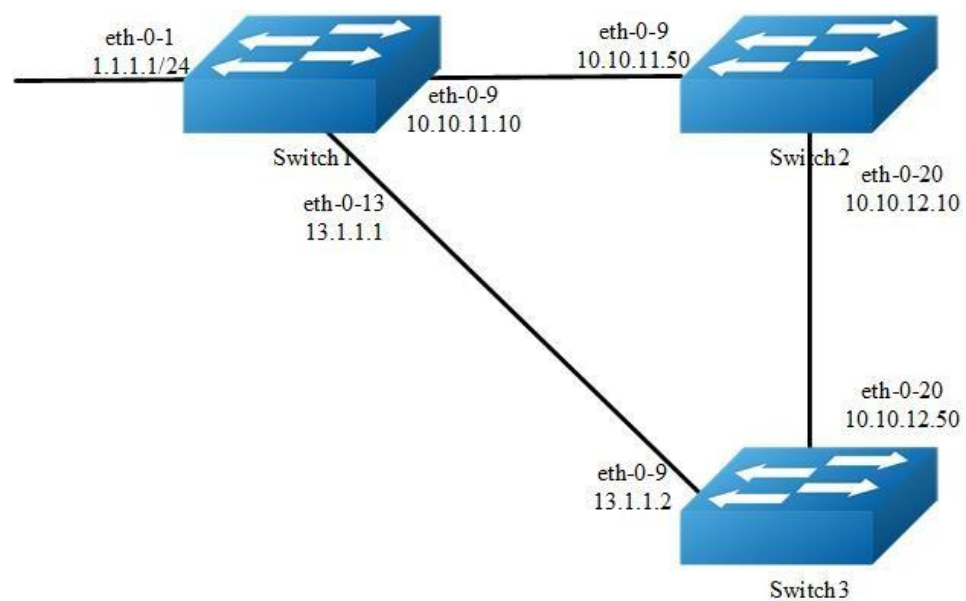

Figure 5-4 rip metric

A RIP offset list allows you to add to the metric of specific inbound or outbound routes learned or advertised by RIP. RIP offset lists provide a simple method for adding to the cost of specific routes and therefore biasing the router's route selection away from those routes. An offset list consists of the following parameters:

- An ACL that specifies the routes to which to add the metric. The direction:
- In: applies to routes the router learns from RIP neighbors.
- Out: applies to routes the router is advertising to its RIP neighbors.
- The offset value that will be added to the routing metric of the routes that match the ACL.
- The interface that the offset list applies (optional).

If a route matches both a global offset list (without specified interface) and an interface-based offset list, the interface-based offset list takes precedence. The interface-based offset list's metric is added to the route in this case.

This example Switch1 will advertise route 1.1.1.0 out of int eth-0-13 with metric 3.

step 1 precondition

Switch1

```
interface eth-0-1
no switchport
ip address 1.1.1.1/24
!
interface eth-0-9
no switchport
ip address 10.10.11.10/24
!
interface eth-0-13
no switchport
ip address 13.1.1.1/24
!
router rip
network 1.1.1.0/24
network 10.10.11.0/24
network 13.1.1.0/24
```

Switch2

```
interface eth-0-9
no switchport
ip address 10.10.11.50/24
!
interface eth-0-20
no switchport
ip address 10.10.12.10/24
!
router rip
network 10.10.11.0/24
network 10.10.12.0/24
```

Switch3

```
interface eth-0-13
no switchport
ip address 13.1.1.2/24
!
interface eth-0-20
no switchport
ip address 10.10.12.50/24
!
router rip
```

```
network 10.10.12.0/24
network 13.1.1.0/24
```

Display the routes on Switch3:

```
Switch# show ip route rip
R      1.1.1.0/24 [120/2] via 13.1.1.1, eth-0-13, 00: 07: 46
R      10.10.11.0/24 [120/2] via 13.1.1.1, eth-0-13, 00: 07: 39
      [120/2] via 10.10.12.10, eth-0-20, 00: 07: 39
Change router 1.1.1.0/24 via 10.10.12.10
```

step 2 Enter the configure mode

The following commands operate on Switch1:

```
Switch# configure terminal
```

step 3 Configuring access list

```
Switch(config)#ip access-list ripoffset
Switch(config-ip-acl)#permit any 1.1.1.0 0.0.0.255 any
```

step 4 Enable RIP routing process and set offset list and offset value for an interface

```
Switch(config-ip-acl)# router rip
Switch(config-router)# offset-list ripoffset out 3 eth-0-13
```

step 5 Exit the configure mode

```
Switch(config-router)# end
```

step 6 Validation

Display the routes on Switch3. The metric for the route which distributed by Switch1 is 3 now.

```
Switch# show ip route rip
R      1.1.1.0/24 [120/3] via 10.10.12.10, eth-0-20, 00: 00: 02
R      10.10.11.0/24 [120/2] via 13.1.1.1, eth-0-13, 00: 11: 40
      [120/2] via 10.10.12.10, eth-0-20, 00: 11: 40
```

Configuring the Administrative Distance

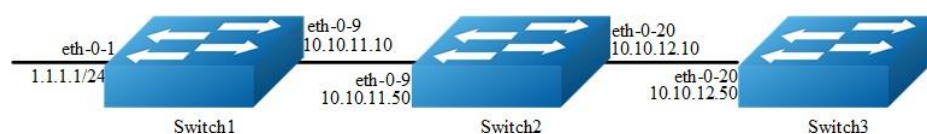

Figure 5-5 rip distance

By default, RIP assigns the default RIP administrative distance (120) to RIP routes. When comparing routes based on administrative distance, the router selects the route with the lower distance. You can change the administrative distance for RIP routes.

This example all Switches have two router protocols, RIP and OSPF, OSPF route has higher priority, Switch3 will change route 1.1.1.0 with administrative distance 100.

step 1 precondition**Switch1**

```
interface eth-0-1
no switchport
ip address 1.1.1.1/24
!
interface eth-0-9
no switchport
ip address 10.10.11.10/24
!
router ospf
network 1.1.1.0/24 area 0
network 10.10.11.0/24 area 0
!
router rip
network 1.1.1.0/24
network 10.10.11.0/24
```

Switch2

```
interface eth-0-9
no switchport
ip address 10.10.11.50/24
!
interface eth-0-20
no switchport
ip address 10.10.12.10/24
!
router ospf
network 10.10.11.0/24 area 0
network 10.10.12.0/24 area 0
!
router rip
network 10.10.11.0/24
network 10.10.12.0/24
```

Switch3

```
interface eth-0-20
no switchport
```

```
ip address 10.10.12.50/24
!
router ospf
network 10.10.12.0/24 area 0
!
router rip
network 10.10.12.0/24
```

Display the routes on Switch3:

```
Switch# show ip route
Codes: K - kernel, C - connected, S - static, R - RIP, B - BGP
       O - OSPF, IA - OSPF inter area
       N1 - OSPF NSSA external type 1, N2 - OSPF NSSA external type 2
       E1 - OSPF external type 1, E2 - OSPF external type 2
       i - IS-IS, L1 - IS-IS level-1, L2 - IS-IS level-2, ia - IS-IS inter area
       [*] - [AD/Metric]
       * - candidate default
O      1.1.1.0/24 [110/3] via 10.10.12.10, eth-0-20, 01: 05: 49
O      10.10.11.0/24 [110/2] via 10.10.12.10, eth-0-20, 01: 05: 49
C      10.10.12.0/24 is directly connected, eth-0-20
C      10.10.12.50/32 is in local loopback, eth-0-20
```

step 2 Enter the configure mode

The following commands operate on Switch3:

```
Switch# configure terminal
```

step 3 Configuring access list

```
Switch(config)#ip access-list ripdistancelist
Switch(config-ip-acl)#permit any 1.1.1.0 0.0.0.255 any
```

step 4 Enable RIP routing process and set administrative distance

```
Switch(config-ip-acl)# router rip
Switch(config-router)# distance 100 0.0.0.0/0 ripdistancelist
```

step 5 Exit the configure mode

```
Switch(config-router)# end
```

step 6 Validation

Display the routes on Switch3. The distance for the rip route is 100 now.

```
Switch# show ip route
Codes: K - kernel, C - connected, S - static, R - RIP, B - BGP
       O - OSPF, IA - OSPF inter area
       N1 - OSPF NSSA external type 1, N2 - OSPF NSSA external type 2
```

```

E1 - OSPF external type 1, E2 - OSPF external type 2
i - IS-IS, L1 - IS-IS level-1, L2 - IS-IS level-2, ia - IS-IS inter area
[*] - [AD/Metric]
* - candidate default
R   1.1.1.0/24 [100/3] via 10.10.12.10, eth-0-20, 00: 00: 02
O   10.10.11.0/24 [110/2] via 10.10.12.10, eth-0-20, 01: 10: 42
C   10.10.12.0/24 is directly connected, eth-0-20
C   10.10.12.50/32 is in local loopback, eth-0-20

```

Configuring Redistribution

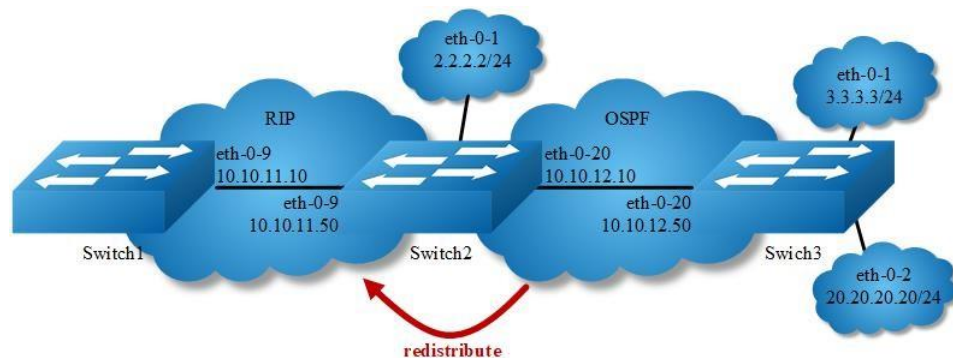

Figure 5-6 rip redistribute

You can configure the router to redistribute static routes, direct connected routes or routes learned through Open Shortest Path First (OSPF) into RIP. When you redistribute a route from one of these other protocols into RIP, the router can use RIP to advertise the route to its RIP neighbors.

Change the default redistribution metric (optional). The router assigns a RIP metric of 1 to each redistributed route by default. You can change the default metric to a value up to 16.

Enable specified routes to redistribute with default or specified metric. This example the router will set the default metric to 2 for redistributed routes and redistributes static routes and direct connected routes to RIP with default metric 2, redistributes OSPF routes with specified metric 5.

step 1 precondition

Switch1

```

interface eth-0-9
no switchport
ip address 10.10.11.10/24
!

```

```
router rip
network 10.10.11.0/24
```

Switch2

```
interface eth-0-1
no switchport
ip address 2.2.2.2/24
!
interface eth-0-9
no switchport
ip address 10.10.11.50/24
!
interface eth-0-20
no switchport
ip address 10.10.12.10/24
!
router ospf
network 10.10.12.0/24 area 0
!
router rip
network 10.10.11.0/24
!
ip route 20.20.20.0/24 10.10.12.50
```

Switch3

```
interface eth-0-1
no switchport
ip address 3.3.3.3/24
!
interface eth-0-2
no switchport
ip address 20.20.20.20/24
!
interface eth-0-20
no switchport
ip address 10.10.12.50/24
!
router ospf
network 3.3.3.0/24 area 0
network 10.10.12.0/24 area 0
```

Display the routes on Switch1:

```
Switch# show ip route
Codes: K - kernel, C - connected, S - static, R - RIP, B - BGP
       O - OSPF, IA - OSPF inter area
       N1 - OSPF NSSA external type 1, N2 - OSPF NSSA external type 2
       E1 - OSPF external type 1, E2 - OSPF external type 2
       i - IS-IS, L1 - IS-IS level-1, L2 - IS-IS level-2, ia - IS-IS inter area
       [*] - [AD/Metric]
       * - candidate default
C       10.10.11.0/24 is directly connected, eth-0-9
C       10.10.11.10/32 is in local loopback, eth-0-9
```

Display the routes on Switch2:

```
Switch# show ip route
Codes: K - kernel, C - connected, S - static, R - RIP, B - BGP
       O - OSPF, IA - OSPF inter area
       N1 - OSPF NSSA external type 1, N2 - OSPF NSSA external type 2
       E1 - OSPF external type 1, E2 - OSPF external type 2
       i - IS-IS, L1 - IS-IS level-1, L2 - IS-IS level-2, ia - IS-IS inter area
       [*] - [AD/Metric]
       * - candidate default

C       2.2.2.0/24 is directly connected, eth-0-1
C       2.2.2.0/32 is in local loopback, eth-0-1
O       3.3.3.0/24 [110/2] via 10.10.12.50, eth-0-20, 01: 05: 41
C       10.10.11.0/24 is directly connected, eth-0-9
C       10.10.11.50/32 is in local loopback, eth-0-9
C       10.10.12.0/24 is directly connected, eth-0-20
C       10.10.12.10/24 is in local loopback, eth-0-20
S       20.20.20.0/24 [1/0] via 10.10.12.50, eth-0-20
```

step 2 Enter the configure mode

The following commands operate on Switch2:

```
Switch# configure terminal
```

step 3 Enable RIP routing process and set metric and enable redistribute

```
Switch(config)# router rip
Switch(config-router)# default-metric 2
Switch(config-router)# redistribute static
Switch(config-router)# redistribute connected
Switch(config-router)# redistribute ospf metric 5
```

redistribute connected routes by ospf (optional)

```
Switch(config)# router ospf
Switch(config-router)# redistribute connected
```

step 4 Exit the configure mode

```
Switch(config-router)# end
```

step 5 Validation

Display the routes on Switch1:

```
Switch# show ip route
Codes: K - kernel, C - connected, S - static, R - RIP, B - BGP
       O - OSPF, IA - OSPF inter area
       N1 - OSPF NSSA external type 1, N2 - OSPF NSSA external type 2
       E1 - OSPF external type 1, E2 - OSPF external type 2
```



```

i - IS-IS, L1 - IS-IS level-1, L2 - IS-IS level-2, ia - IS-IS inter area
[*] - [AD/Metric]
* - candidate default
R   2.2.2.0/24 [120/3] via 10.10.11.50, eth-0-9, 00: 02: 36
R   3.3.3.0/24 [120/6] via 10.10.11.50, eth-0-9, 00: 02: 26
C   10.10.11.0/24 is directly connected, eth-0-9
C   10.10.11.10/32 is in local loopback eth-0-9
R   10.10.12.0/24 [120/3] via 10.10.11.50, eth-0-9, 00: 02: 36
R   20.20.20.0/24 [120/3] via 10.10.11.50, eth-0-9, 00: 02: 41

```

Configuring Split-horizon Parameters

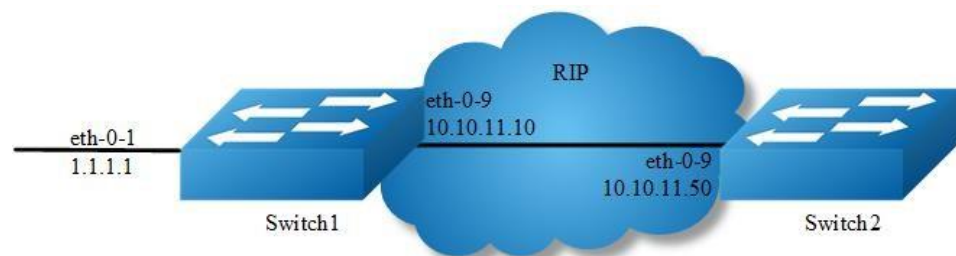

Figure 5-7 rip split-horizon

Normally, routers that are connected to broadcast-type IP networks and that use distance-vector routing protocols employ the split horizon mechanism to reduce the possibility of routing loops. Split horizon blocks information about routes from being advertised by a router out of any interface from which that information originated. This behavior usually optimizes communications among multiple routers, particularly when links are broken. However, with non-broadcast networks (such as Frame Relay), situations can arise for which this behavior is less than ideal. For these situations, you might want to disable split horizon for RIP.

You can avoid including routes in updates sent to the same gateway from which they were learned. Using the split horizon command omits routes learned from one neighbor, in updates sent to that neighbor. Using the poisoned parameter with this command includes such routes in updates, but sets their metrics to infinity. Thus, advertising these routes means that they are not reachable.

step 1 precondition

Switch1

```

interface eth-0-1
no switchport
ip address 1.1.1.1/24
!

```

```
interface eth-0-9
no switchport
ip address 10.10.11.10/24
!
router rip
network 10.10.11.0/24
redistribute connected
```

Switch2

```
interface eth-0-9
no switchport
ip address 10.10.11.50/24
!
router rip
network 10.10.11.0/24
```

step 2 Enabling debug on Switch2 (optional)

```
Switch# debug rip packet send detail
Switch# terminal monitor
```

step 3 Enter the configure mode

The following commands operate on Switch2:

```
Switch# configure terminal
```

step 4 Enter the interface configure mode and set split-horizon

Disable Split-horizon:

```
Switch(config)#interface eth-0-9
Switch(config-if)# no ip rip split-horizon
```

If debug is enabled, the following messages will be shown:

```
Apr  8 06: 24: 25 Switch RIP4-7:  SEND[eth-0-9]:  Send to 224.0.0.9: 520
Apr  8 06: 24: 25 Switch RIP4-7:  SEND[eth-0-9]:  RESPONSE version 2 packet size 44
Apr  8 06: 24: 25 Switch RIP4-7:  1.1.1.0/24 -> 0.0.0.0 family 2 tag 0 metric 2
Apr  8 06: 24: 25 Switch RIP4-7:  10.10.11.0/24 -> 0.0.0.0 family 2 tag 0 metric 1
```

Enable Split-horizon and poisoned:

```
Switch(config-if)# ip rip split-horizon
Switch(config-if)# ip rip split-horizon poisoned
```

If debug is enabled, the following messages will be shown:

```
Apr  8 06: 38: 35 Switch RIP4-7:  SEND[eth-0-9]:  Send to 224.0.0.9: 520
Apr  8 06: 38: 35 Switch RIP4-7:  SEND[eth-0-9]:  RESPONSE version 2 packet size 44
Apr  8 06: 38: 35 Switch RIP4-7:  1.1.1.0/24 -> 0.0.0.0 family 2 tag 0 metric 16
Apr  8 06: 38: 35 Switch RIP4-7:  10.10.11.0/24 -> 0.0.0.0 family 2 tag 0 metric 16
```

step 5 Exit the configure mode

```
Switch(config-router)# end
```

step 6 Validation

Use the following command to display the configuration:

```
Switch# show running-config
interface eth-0-9
  no switchport
  ip address 10.10.11.50/24
!
router rip
  network 10.10.11.0/24
!
```

Use the following command to display the interface of rip:

```
Switch# show ip rip interface
eth-0-9 is up, line protocol is up
  Routing Protocol:  RIP
    Receive RIP packets
    Send RIP packets
    Passive interface:  Disabled
    Split horizon:    Enabled with Poisoned Reversed
    IP interface address:
      10.10.11.50/24
```

Configuring Timers

RIP use several timers that determine such variables as the frequency of routing updates, the length of time before a route becomes invalid, and other parameters. You can adjust these timers to tune RIP performance to better suit your internet-work needs. You can make the following timer adjustments:

- The rate (time in seconds between updates) at which routing updates are sent.
- The interval of time (in seconds) after which a route is declared invalid.
- The amount of time (in seconds) that must pass before a route is removed from the routing table.

step 1 Enter the configure mode

```
Switch# configure terminal
```

step 2 Enable RIP routing process and set the timers

Specify the routing table update timer in 10 seconds. Specifies the routing information timeout timer in 180 seconds. Specifies the routing garbage collection timer in 120 seconds:

```
Switch(config)# router rip
Switch(config-router)# timers basic 10 180 120
```

step 3 Exit the configure mode

```
Switch(config-router)# end
```

step 4 Validation

Use the following command to display the protocol state of rip process:

```
Switch# show ip protocols rip
Routing protocol is "rip"
  Sending updates every 10 seconds with +/-5 seconds, next due in 2 seconds
  Timeout after 180 seconds, Garbage collect after 120 seconds
  Outgoing update filter list for all interface is not set
  Incoming update filter list for all interface is not set
  Default redistribution metric is 1
  Redistributing:
  Default version control:  send version 2, receive version 2
    Interface      Send      Recv      Key-chain
    eth-0-9        2         2
  Routing for Networks:
    10.10.11.0/24
  Routing Information Sources:
    Gateway          Distance  Last Update  Bad Packets  Bad Routes
    10.10.11.50      120      00: 00: 02      0            0
  Number of routes (including connected):  5
  Distance:  (default is 120)
```

Configuring RIP Route Distribute Filters

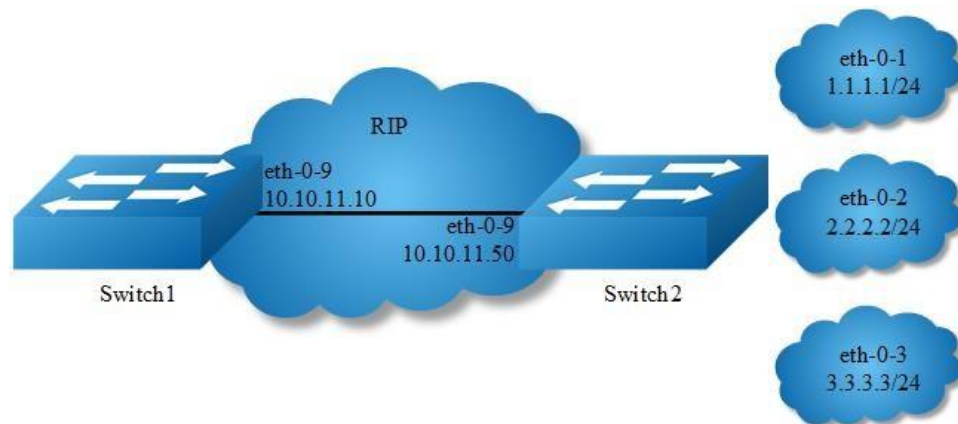

Figure 5-8 rip filter list

A RIP distribute list allows you to permit or deny learning or advertising of specific routes. A distribute list consists of the following parameters:

- An ACL or a prefix list that filter the routes.
- The direction:

In: filter applies to learned routes.

Out: filter applies to advertised routes - The interface that the filter applies (optional).

step 1 precondition

Switch1

```
interface eth-0-9
no switchport
ip address 10.10.11.10/24
!
router rip
network 10.10.11.0/24
```

Switch2

```
interface eth-0-1
no switchport
ip address 1.1.1.1/24
!
interface eth-0-2
no switchport
ip address 2.2.2.2/24
!
interface eth-0-3
```

```
no switchport
ip address 3.3.3.3/24
!
interface eth-0-9
no switchport
ip address 10.10.11.50/24
!
router rip
network 1.1.1.0/24
network 2.2.2.0/24
network 3.3.3.0/24
network 10.10.11.0/24
```

Display the routes on Switch1:

```
Switch# show ip route
Codes: K - kernel, C - connected, S - static, R - RIP, B - BGP
       O - OSPF, IA - OSPF inter area
       N1 - OSPF NSSA external type 1, N2 - OSPF NSSA external type 2
       E1 - OSPF external type 1, E2 - OSPF external type 2
       i - IS-IS, L1 - IS-IS level-1, L2 - IS-IS level-2, ia - IS-IS inter area
       [*] - [AD/Metric]
       * - candidate default
R      1.1.1.0/24 [120/2] via 10.10.11.50, eth-0-9, 00:01:50
R      2.2.2.0/24 [120/2] via 10.10.11.50, eth-0-9, 00:01:50
R      3.3.3.0/24 [120/2] via 10.10.11.50, eth-0-9, 00:01:50
C      10.10.11.0/24 is directly connected, eth-0-9
C      10.10.11.10/32 is in local loopback, eth-0-9
```

step 2 Enter the configure mode

The following commands operate on Switch2:

```
Switch# configure terminal
```

step 3 Configuring prefix list

```
Switch(config)# ip prefix-list 1 deny 1.1.1.0/24
Switch(config)# ip prefix-list 1 permit any
```

step 4 Apply prefix list

```
Switch(config)# router rip
Switch(config-router)# distribute-list prefix 1 out
```

step 5 Exit the configure mode

```
Switch(config-router)# end
```

step 6 Validation

Display the routes on Switch1:

```
Switch# show ip route
Codes: K - kernel, C - connected, S - static, R - RIP, B - BGP
       O - OSPF, IA - OSPF inter area
       N1 - OSPF NSSA external type 1, N2 - OSPF NSSA external type 2
       E1 - OSPF external type 1, E2 - OSPF external type 2
       i - IS-IS, L1 - IS-IS level-1, L2 - IS-IS level-2, ia - IS-IS inter area
       [*] - [AD/Metric]
       * - candidate default

R      2.2.2.0/24 [120/2] via 10.10.11.50, eth-0-9, 00:00:08
R      3.3.3.0/24 [120/2] via 10.10.11.50, eth-0-9, 00:00:08
C      10.10.11.0/24 is directly connected, eth-0-9
C      10.10.11.10/32 is in local loopback, eth-0-9
```

Configuring RIPv2 authentication (single key)

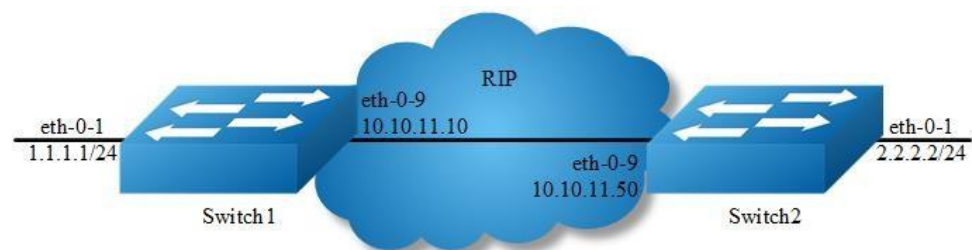

Figure 5-9 rip authentication

RIPv2 supports 2 authentication methods: plaintext and MD5 encryption.

The following example shows how to enable plaintext authentication.

To using this feature, the following steps are required:

- Specify an interface and set the authentication string
- Specify the authentication mode as "text"

step 1 Enter the configure mode

```
Switch# configure terminal
```

step 2 Enter the interface configure mode, set the attributes and ip address

Switch1:

```
Switch(config)# interface eth-0-1
Switch(config-if)# no switchport
```

```
Switch(config-if)# no shutdown
Switch(config-if)# ip address 1.1.1.1/24
Switch(config-if)# exit

Switch(config-if)# interface eth-0-9
Switch(config-if)# no switchport
Switch(config-if)# no shutdown
Switch(config-if)# ip address 10.10.11.10/24
Switch(config-if)# exit
```

Switch2:

```
Switch(config)# interface eth-0-1
Switch(config-if)# no switchport
Switch(config-if)# no shutdown
Switch(config-if)# ip address 2.2.2.2/24
Switch(config-if)# exit

Switch(config-if)# interface eth-0-9
Switch(config-if)# no switchport
Switch(config-if)# no shutdown
Switch(config-if)# ip address 10.10.11.50/24
Switch(config-if)# exit
```

step 3 Enable RIP routing process and set the parameters

```
Switch(config)# router rip
Switch(config-router)# network 10.10.11.0/24
Switch(config-router)# redistribute connected
Switch(config-router)# exit
```

step 4 Specify the authentication string and mode

```
Switch(config)# interface eth-0-9
Switch(config-if)# ip rip authentication string Auth1
Switch(config-if)# ip rip authentication mode text
```

step 5 Exit the configure mode

```
Switch(config-if)# end
```

step 6 Validation

Use the following command to display the database of rip:

```
Switch# show ip rip database

Codes: R - RIP, Rc - RIP connected, Rs - RIP static, K - Kernel,
       C - Connected, S - Static, O - OSPF, I - IS-IS, B - BGP

Network          Next Hop          Metric From      If              Time
```



```
R 2.2.2.0/24          10.10.11.50          2 10.10.11.50      eth-0-9  00:02:52
Rc 10.10.11.0/24
```

Use the following command to display the protocol state of rip process:

```
Switch# show ip protocols rip
Routing protocol is "rip"
  Sending updates every 30 seconds with +/-5 seconds, next due in 23 seconds
  Timeout after 180 seconds, Garbage collect after 120 seconds
  Outgoing update filter list for all interface is not set
  Incoming update filter list for all interface is not set
  Default redistribution metric is 1
  Redistributing:
    connected metric default
  Default version control: send version 2, receive version 2
  Interface          Send          Recv          Key-chain
  eth-0-9            2             2
  Routing for Networks:
    10.10.11.0/24
  Routing Information Sources:
  Gateway            Distance    Last Update   Bad Packets   Bad Routes
  10.10.11.50        120        00:00:45     1             0
  Number of routes (including connected): 2
  Distance: (default is 120)
```

```
Switch# show ip rip interface
eth-0-9 is up, line protocol is up
  Routing Protocol: RIP
  Receive RIP packets
  Send RIP packets
  Passive interface: Disabled
  Split horizon: Enabled with Poisoned Reversed
  IP interface address:
    10.10.11.10/24
```

Use the following command to display the interface of rip:

```
Switch# show ip route
Codes: K - kernel, C - connected, S - static, R - RIP, B - BGP
       O - OSPF, IA - OSPF inter area
       N1 - OSPF NSSA external type 1, N2 - OSPF NSSA external type 2
       E1 - OSPF external type 1, E2 - OSPF external type 2
       i - IS-IS, L1 - IS-IS level-1, L2 - IS-IS level-2, ia - IS-IS inter area
       Dc - DHCP Client
       [*] - [AD/Metric]
       * - candidate default

R      2.2.2.0/24 [120/2] via 10.10.11.50, eth-0-9, 00:02:28
C      10.10.11.0/24 is directly connected, eth-0-9
C      10.10.11.10/32 is in local loopback, eth-0-9
```

Configuring RIPv2 MD5 authentication (multiple keys)

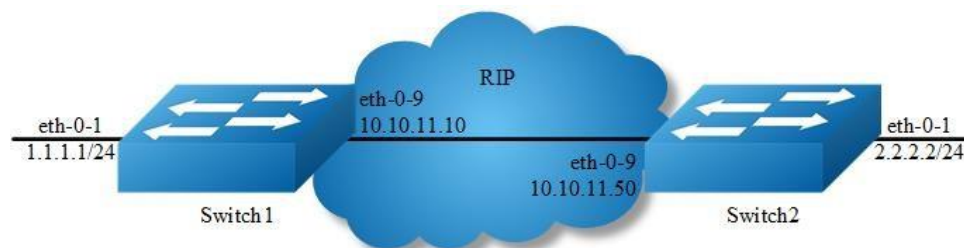

Figure 5-10 rip authentication

This example illustrates the md5 authentication of the routing information exchange process for RIPv2 using multiple keys. Switch1 and B are running RIPv2 and exchange routing updates. To configure authentication on Switch1, define a key chain, specify keys in the key chain and then define the authentication string or passwords to be used by the keys. Then set the time period during which it is valid to receive or send the authentication key by specifying the accept and send lifetimes.[optional].After defining the key string, specify the key chain (or the set of keys) that will be used for authentication on the interface and the authentication mode to be used. Configure Switch1 and B to have the same key ID and key string as Switch1 for the time that updates need to be exchanged.

In md5 authentication, both the key ID and key string are matched for authentication. R1 will receive only packets that match both the key ID and the key string in the specified key chain (within the accept lifetime) on that interface In the following example, Switch2 has the same key ID and key string as Switch1. For additional security, the accept lifetime and send lifetime are configured such that every fifth day the key ID and key string changes. To maintain continuity, the accept lifetimes should be configured to overlap; however, the send lifetime should not be overlapping.

step 1 Enter the configure mode

```
Switch# configure terminal
```

step 2 Enter the interface configure mode, set the attributes and ip address

Switch1:

```
Switch(config)# interface eth-0-1
Switch(config-if)# no switchport
```

```
Switch(config-if) # no shutdown
Switch(config-if) # ip address 1.1.1.1/24
Switch(config-if) # exit

Switch(config-if) # interface eth-0-9
Switch(config-if) # no switchport
Switch(config-if) # no shutdown
Switch(config-if) # ip address 10.10.11.10/24
Switch(config-if) # exit
```

Switch2:

```
Switch(config) # interface eth-0-1
Switch(config-if) # no switchport
Switch(config-if) # no shutdown
Switch(config-if) # ip address 2.2.2.2/24
Switch(config-if) # exit

Switch(config-if) # interface eth-0-9
Switch(config-if) # no switchport
Switch(config-if) # no shutdown
Switch(config-if) # ip address 10.10.11.50/24
Switch(config-if) # exit
```

step 3 Enable RIP routing process and set the parameters

```
Switch(config) # router rip
Switch(config-router) # network 10.10.11.0/24
Switch(config-router) # redistribute connected
Switch(config-router) # exit
```

step 4 Create a key chain , and set the key string and lifetime

```
Switch(config) # key chain SUN
Switch(config-keychain) # key 1
Switch(config-keychain-key) # key-string key1
Switch(config-keychain-key) # accept-lifetime 12:00:00 Mar 2 2012 14:00:00 Mar 7
2012
Switch(config-keychain-key) # send-lifetime 12:00:00 Mar 2 2012 12:00:00 Mar 7 2012
Switch(config-keychain-key) # exit
```

Another key (optional):

```
Switch(config-keychain) # key 2
Switch(config-keychain-key) # key-string Earth
Switch(config-keychain-key) # accept-lifetime 12:00:00 Mar 7 2012 14:00:00 Mar 12
2012
Switch(config-keychain-key) # send-lifetime 12:00:00 Mar 7 2012 12:00:00 Mar 12 2012
Switch(config-keychain-key) # exit
```

Exit the keychain configure mode:

```
Switch(config-keychain) # exit
```

step 5 Specify the authentication string and mode

```
Switch(config)# interface eth-0-9
Switch(config-if)# ip rip authentication key-chain SUN
Switch(config-if)# ip rip authentication mode md5
```

step 6 Exit the configure mode

```
Switch(config-if)# end
```

step 7 Validation

Use the following command to display the database of rip:

```
Switch# show ip rip database

Codes: R - RIP, Rc - RIP connected, Rs - RIP static, K - Kernel,
       C - Connected, S - Static, O - OSPF, I - IS-IS, B - BGP

Network          Next Hop          Metric From      If              Time
R 2.2.2.0/24      10.10.11.50      2 10.10.11.50    eth-0-9         00:01:10
Rc 10.10.11.0/24                1                eth-0-9
```

Use the following command to display the protocol state of rip process:

```
Switch# show ip protocols rip
Routing protocol is "rip"
  Sending updates every 30 seconds with +/-5 seconds, next due in 17 seconds
  Timeout after 180 seconds, Garbage collect after 120 seconds
  Outgoing update filter list for all interface is not set
  Incoming update filter list for all interface is not set
  Default redistribution metric is 1
  Redistributing:
    connected metric default
  Default version control: send version 2, receive version 2
  Interface      Send      Recv      Key-chain
  eth-0-9        2         2         SUN
  Routing for Networks:
    10.10.11.0/24
  Routing Information Sources:
    Gateway      Distance  Last Update  Bad Packets  Bad Routes
  Number of routes (including connected): 2
  Distance: (default is 120)
```

Use the following command to display the interface of rip:

```
Switch# show ip rip interface
eth-0-9 is up, line protocol is up
  Routing Protocol: RIP
  Receive RIP packets
  Send RIP packets
  Passive interface: Disabled
  Split horizon: Enabled with Poisoned Reversed
```

```
IP interface address:
10.10.11.10/24
```

Use the following command to display routes on the device:

```
Switch# show ip route
Codes: K - kernel, C - connected, S - static, R - RIP, B - BGP
       O - OSPF, IA - OSPF inter area
       N1 - OSPF NSSA external type 1, N2 - OSPF NSSA external type 2
       E1 - OSPF external type 1, E2 - OSPF external type 2
       i - IS-IS, L1 - IS-IS level-1, L2 - IS-IS level-2, ia - IS-IS inter area
       Dc - DHCP Client
       [*] - [AD/Metric]
       * - candidate default

C       1.1.1.0 /24 is directly connected, eth-0-1
C       1.1.1.1 /32 is in local loopback, eth-0-1
R       2.2.2.0/24 [120/2] via 10.10.11.50, eth-0-9, 00:02:27
C       10.10.11.0/24 is directly connected, eth-0-9
C       10.10.11.10/32 is in local loopback, eth-0-9
```

Use the following command to display key chain:

```
Switch# show key chain
key chain SUN:
  key 1 -- text "key1"
    accept-lifetime <12:00:00 Mar 02 2012> - <14:00:00 Mar 07 2012>
    send-lifetime <12:00:00 Mar 02 2012> - < 12:00:00 Mar 07 2012>
  key 2 -- text "Earth"
    accept-lifetime <12:00:00 Mar 07 2012> - <14:00:00 Mar 12 2012>
    send-lifetime <12:00:00 Mar 07 2012> - < 12:00:00 Mar 12 2012>
Switch#
```

5.2.3 Application cases

N/A

5.3 Configuring OSPF

5.3.1 Overview

Function Introduction

OSPF is an Interior Gateway Protocol (IGP) designed expressly for IP networks, supporting IP subnet ting and tagging of externally derived routing information. OSPF also allows packet authentication and uses IP multicast when sending and receiving packets.

The implementation conforms to the OSPF Version 2 specifications with these key features:

- Definition of stub areas is supported: Routes learned through any IP routing protocol can be redistributed into another IP routing protocol. At the intradomain level, this means that OSPF can import routes learned through RIP. OSPF routes can also be exported into RIP.
- Plain text and MD5 authentication among neighboring routers within an area is supported: Configurable routing interface parameters include interface output cost, retransmission interval, interface transmit delay, router priority, router dead and hello intervals, and authentication key.

OSPF typically requires coordination among many internal routers, area border routers (ABRs) connected to multiple areas, and autonomous system boundary routers (ASBRs). The minimum configuration would use all default parameter values, no authentication, and interfaces assigned to areas. If you customize your environment, you must ensure coordinated configuration of all routers.

Principle Description

Reference to RFC 2328

5.3.2 Configuration

Basic OSPF Parameters Configuration

step 1 Enter the configure mode

```
Switch# configure terminal
```

step 2 Configure the Routing process and associate the network with a specified OSPF area

```
Switch(config)# router ospf 100  
Switch(config-router)# network 10.10.10.0/24 area 0  
Switch(config-router)# quit
```

Note:use the following command to delete the routing process

```
Switch(config)# no router ospf 100
```

step 3 Exit the configure mode

```
Switch(config)# end
```

step 4 Validation

```
Switch# show ip protocols
Routing Protocol is "ospf 100"
  Redistributing:
  Routing for Networks:
    10.10.10.0/24
  Distance: (default is 110)
```

Enabling OSPF on an Interface**Figure 5-11 ospf**

This example shows the minimum configuration required for enabling OSPF on an interface. Switch1 and 2 are two routers in Area 0 connecting to network 10.10.10.0/24.



NOTE Configure one interface so that it belongs to only one area. However, you can configure different interfaces on a router to belong to different areas.

step 1 Enter the configure mode

```
Switch# configure terminal
```

step 2 Enter the interface configure mode, set the attributes and ip address

Configure on Switch1:

```
Switch(config)# interface eth-0-9
Switch(config-if)# no switchport
Switch(config-if)# no shutdown
Switch(config-if)# ip address 10.10.10.10/24
Switch(config-if)# exit
```

Configure on Switch2:

```
Switch(config)# interface eth-0-9
Switch(config-if)# no switchport
Switch(config-if)# no shutdown
Switch(config-if)# ip address 10.10.10.11/24
Switch(config-if)# exit
```

step 3 Configure the Routing process and associate the network with a specified OSPF area**Configure on Switch1:**

```
Switch(config)# router ospf 100
Switch(config-router)# network 10.10.10.0/24 area 0
```

Configure on Switch2:

```
Switch(config)# router ospf 200
Switch(config-router)# network 10.10.10.0/24 area 0
```

Note: To using OSPF among two devices which are directly connected, the area IDs must be same. The ospf process IDs can be same or different.

step 4 Exit the configure mode

```
Switch(config-router)# end
```

step 5 Validation

Use the following command to display the database of ospf:

```
Switch# show ip ospf database

          OSPF Router with ID (10.10.10.10) (Process ID 100)

          Router Link States (Area 0)

Link ID        ADV Router      Age  Seq#           CkSum  Link count
10.10.10.10    10.10.10.10    26  0x80000006    0x1499  1
10.10.10.11    10.10.10.11    27  0x80000003    0x1895  1

          Net Link States (Area 0)

Link ID        ADV Router      Age  Seq#           CkSum
10.10.10.10    10.10.10.10    26  0x80000001    0xdfd8
```

Use the following command to display the interface of ospf:

```
Switch# show ip ospf interface
eth-0-9 is up, line protocol is up
```



```

Internet Address 10.10.10.10/24, Area 0, MTU 1500
Process ID 100, Router ID 10.10.10.10, Network Type BROADCAST, Cost: 1
Transmit Delay is 1 sec, State DR, Priority 1, TE Metric 1
Designated Router (ID) 10.10.10.10, Interface Address 10.10.10.10
Backup Designated Router (ID) 10.10.10.11, Interface Address 10.10.10.11
Timer intervals configured, Hello 10, Dead 40, Wait 40, Retransmit 5
  Hello due in 00:00:06
Neighbor Count is 1, Adjacent neighbor count is 1
Crypt Sequence Number is 1527047183
Hello received 25 sent 576, DD received 4 sent 4
LS-Req received 1 sent 1, LS-Upd received 3 sent 3
LS-Ack received 2 sent 2, Discarded 0

```

Use the following command to display the neighbor of ospf:

Switch1:

```

Switch# show ip ospf neighbor

OSPF process 100:
Neighbor ID      Pri   State           Dead Time   Address      Interface
10.10.10.11     1    Full/Backup     00:00:33   10.10.10.11 eth-0-9

```

Switch2:

```

Switch# show ip ospf neighbor

OSPF process 200:
Neighbor ID      Pri   State           Dead Time   Address      Interface
10.10.10.10     1    Full/DR         00:00:33   10.10.10.10 eth-0-9

```

Use the following command to display the ospf routes:

```

Switch# show ip ospf route

OSPF process 100:
Codes: C - connected, D - Discard, O - OSPF, IA - OSPF inter area
       N1 - OSPF NSSA external type 1, N2 - OSPF NSSA external type 2
       E1 - OSPF external type 1, E2 - OSPF external type 2

C 10.10.10.0/24 [1] is directly connected, eth-0-9, Area 0

```

Configuring Priority

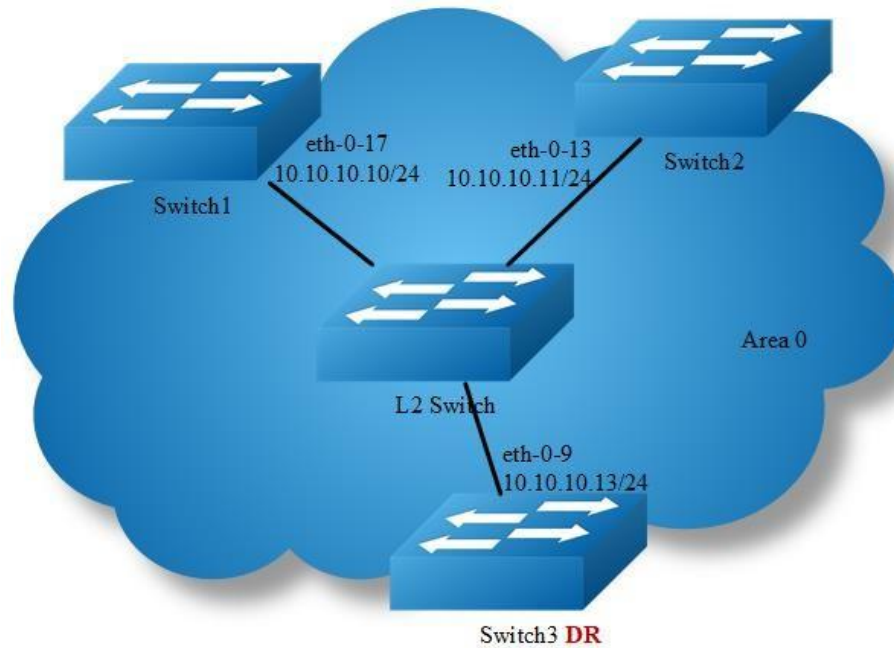

Figure 5-12 ospf priority

This example shows the configuration for setting the priority for an interface. You can set a high priority for a router to make it the Designated Router (DR). Router Switch3 is configured to have a priority of 10, which is higher than the default priority (default priority is 1) of Switch1 and 2; making it the DR.

step 1 Enter the configure mode

```
Switch# configure terminal
```

step 2 Enter the interface configure mode, set the attributes and ip address

Configure on Switch1:

```
Switch(config)# interface eth-0-17
Switch(config-if)# no switchport
Switch(config-if)# no shutdown
Switch(config-if)# ip address 10.10.10.10/24
Switch(config-if)# quit
```

Configure on Switch2:

```
Switch(config)# interface eth-0-13
Switch(config-if)# no switchport
Switch(config-if)# no shutdown
```

```
Switch(config-if)# ip address 10.10.10.11/24
Switch(config-if)# quit
```

Configure on Switch3:

```
Switch(config)# interface eth-0-9
Switch(config-if)# no switchport
Switch(config-if)# no shutdown
Switch(config-if)# ip address 10.10.10.13/24
Switch(config-if)# quit
```

Configure on L2 Switch:

```
Switch(config)# interface eth-0-9
Switch(config-if)# no shutdown
Switch(config-if)# quit
Switch(config)# interface eth-0-13
Switch(config-if)# no shutdown
Switch(config-if)# quit
Switch(config)# interface eth-0-17
Switch(config-if)# no shutdown
Switch(config-if)# quit
```

step 3 Specify the router priority

Configure on Switch3:

```
Switch(config)# interface eth-0-9
Switch(config-if)# ip ospf priority 10
Switch(config-if)# quit
```

step 4 Configure the Routing process and associate the network with a specified OSPF area

```
Switch(config)# router ospf 100
Switch(config-router)# network 10.10.10.0/24 area 0
Switch(config-if)# quit
```

step 5 Exit the configure mode

```
Switch(config)# end
```

step 6 Validation

Use the following command to display the neighbor of ospf:

Switch1:

```
Switch# show ip ospf neighbor

OSPF process 100:
```

Neighbor ID	Pri	State	Dead Time	Address	Interface
10.10.10.11	1	Full/Backup	00:00:31	10.10.10.11	eth-0-17
10.10.10.13	10	Full/DR	00:00:38	10.10.10.13	eth-0-17

Switch2:

```
Switch# show ip ospf neighbor

OSPF process 100:
Neighbor ID      Pri   State           Dead Time   Address      Interface
10.10.10.10     1     Full/DROther    00:00:39   10.10.10.10 eth-0-13
10.10.10.13     10    Full/DR         00:00:32   10.10.10.13 eth-0-13
```

Switch3:

```
Switch# show ip ospf neighbor

OSPF process 100:
Neighbor ID      Pri   State           Dead Time   Address      Interface
10.10.10.10     1     Full/DROther    00:00:37   10.10.10.10 eth-0-9
10.10.10.11     1     Full/Backup     00:00:32   10.10.10.11 eth-0-9
```

Use the following command to display the interface of ospf:

Switch1:

```
Switch# show ip ospf interface
eth-0-17 is up, line protocol is up
  Internet Address 10.10.10.10/24, Area 0, MTU 1500
  Process ID 100, Router ID 10.10.10.10, Network Type BROADCAST, Cost: 1
  Transmit Delay is 1 sec, State DROther, Priority 1, TE Metric 1
  Designated Router (ID) 10.10.10.13, Interface Address 10.10.10.13
  Backup Designated Router (ID) 10.10.10.11, Interface Address 10.10.10.11
  Timer intervals configured, Hello 10, Dead 40, Wait 40, Retransmit 5
  Hello due in 00:00:10
  Neighbor Count is 2, Adjacent neighbor count is 2
  Crypt Sequence Number is 1527056133
  Hello received 106 sent 54, DD received 8 sent 9
  LS-Req received 2 sent 3, LS-Upd received 8 sent 5
  LS-Ack received 9 sent 5, Discarded 3
```

Switch2:

```
Switch# show ip ospf interface
eth-0-13 is up, line protocol is up
  Internet Address 10.10.10.11/24, Area 0, MTU 1500
  Process ID 100, Router ID 10.10.10.11, Network Type BROADCAST, Cost: 1
  Transmit Delay is 1 sec, State Backup, Priority 1, TE Metric 1
  Designated Router (ID) 10.10.10.13, Interface Address 10.10.10.13
  Backup Designated Router (ID) 10.10.10.11, Interface Address 10.10.10.11
  Timer intervals configured, Hello 10, Dead 40, Wait 40, Retransmit 5
  Hello due in 00:00:10
  Neighbor Count is 2, Adjacent neighbor count is 2
  Crypt Sequence Number is 1527056130
  Hello received 110 sent 56, DD received 8 sent 7
```

```
LS-Req received 3 sent 2, LS-Upd received 12 sent 6
LS-Ack received 11 sent 8, Discarded 0
```

Switch3:

```
Switch# show ip ospf interface
eth-0-9 is up, line protocol is up
  Internet Address 10.10.10.13/24, Area 0, MTU 1500
  Process ID 100, Router ID 10.10.10.13, Network Type BROADCAST, Cost: 1
  Transmit Delay is 1 sec, State DR, Priority 10, TE Metric 1
  Designated Router (ID) 10.10.10.13, Interface Address 10.10.10.13
  Backup Designated Router (ID) 10.10.10.11, Interface Address 10.10.10.11
  Timer intervals configured, Hello 10, Dead 40, Wait 40, Retransmit 5
    Hello due in 00:00:01
  Neighbor Count is 2, Adjacent neighbor count is 2
  Crypt Sequence Number is 1527056127
  Hello received 32 sent 16, DD received 9 sent 9
  LS-Req received 2 sent 2, LS-Upd received 11 sent 8
  LS-Ack received 10 sent 8, Discarded 0
```

1.3.6 Configuring OSPF Area Parameters

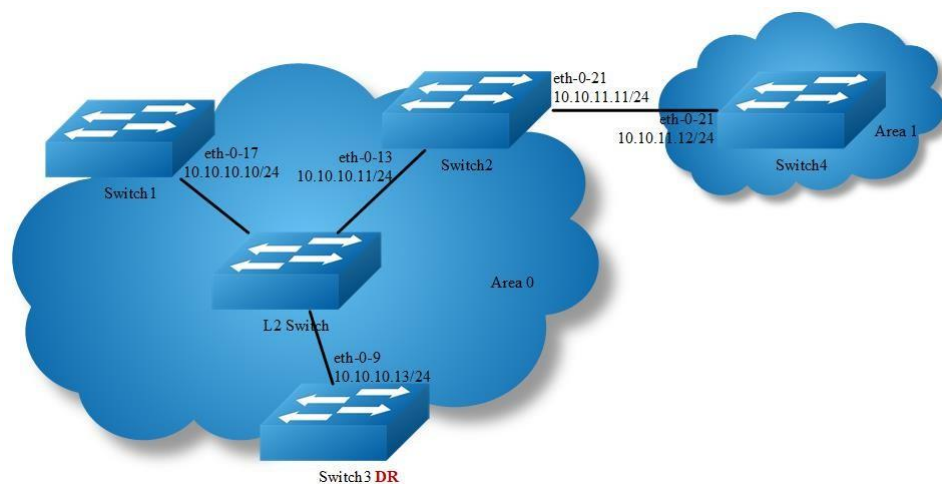

Figure 5-13 ospf area

You can optionally configure several OSPF area parameters. These parameters include authentication for password-based protection against unauthorized access to an area and stub areas. Stub areas are areas into which information on external routes is not sent. Instead, the area border router (ABR) generates a default external route into the stub area for destinations outside the autonomous system (AS).

Route summarization is the consolidation of advertised addresses into a single summary route to be advertised by other areas. If network numbers are contiguous, you can use the area range router configuration command to configure the ABR to advertise a summary route that covers all networks in the range.

step 1 Enter the configure mode

```
Switch# configure terminal
```

step 2 Enter the interface configure mode, set the attributes and ip address

Configure on Switch1:

```
Switch(config)# interface eth-0-17
Switch(config-if)# no switchport
Switch(config-if)# no shutdown
Switch(config-if)# ip address 10.10.10.10/24
Switch(config-if)# quit
```

Configure on Switch2:

```
Switch(config)# interface eth-0-13
Switch(config-if)# no switchport
Switch(config-if)# no shutdown
Switch(config-if)# ip address 10.10.10.11/24
Switch(config-if)# quit
```

```
Switch(config)# interface eth-0-21
Switch(config-if)# no switchport
Switch(config-if)# no shutdown
Switch(config-if)# ip address 10.10.11.11/24
Switch(config-if)# quit
```

Configure on Switch3:

```
Switch(config)# interface eth-0-9
Switch(config-if)# no switchport
Switch(config-if)# no shutdown
Switch(config-if)# ip address 10.10.10.13/24
Switch(config-if)# quit
```

Configure on Switch4:

```
Switch(config)# interface eth-0-21
Switch(config-if)# no switchport
Switch(config-if)# no shutdown
Switch(config-if)# ip address 10.10.11.12/24
Switch(config-if)# quit
```

Configure on L2 Switch:

```
Switch(config)# interface eth-0-9
Switch(config-if)# no shutdown
Switch(config-if)# quit
Switch(config)# interface eth-0-13
Switch(config-if)# no shutdown
Switch(config-if)# quit
Switch(config)# interface eth-0-17
```

```
Switch(config-if) # no shutdown
Switch(config-if) # quit
```

step 3 Set the ospf priority on the interface

Configure on Switch3:

```
Switch(config) # interface eth-0-9
Switch(config-if) # ip ospf priority 10
Switch(config-if) # quit
```

step 4 Configure the Routing process and associate the network with a specified OSPF area

Configure on Switch1:

```
Switch(config) # router ospf 100
Switch(config-router) # network 10.10.10.0/24 area 0
Switch(config-router) # quit
```

Configure on Switch2:

```
Switch(config) # router ospf 100
Switch(config-router) # network 10.10.10.0/24 area 0
Switch(config-router) # network 10.10.11.0/24 area 1
Switch(config-router) # area 0 range 10.10.10.0/24
Switch(config-router) # area 1 stub no-summary
Switch(config-router) # quit
```

Configure on Switch3:

```
Switch(config) # router ospf 100
Switch(config-router) # network 10.10.10.0/24 area 0
Switch(config-router) # quit
```

Configure on Switch4:

```
Switch(config) # router ospf 200
Switch(config-router) # network 10.10.11.0/24 area 1
Switch(config-router) # area 1 stub no-summary
Switch(config-router) # quit
```

step 5 Exit the configure mode

```
Switch(config) # end
```

step 6 Validation

Use the following command to display the ospf routes:

Switch1:

```
Switch# show ip route
Codes: K - kernel, C - connected, S - static, R - RIP, B - BGP
       O - OSPF, IA - OSPF inter area
       N1 - OSPF NSSA external type 1, N2 - OSPF NSSA external type 2
       E1 - OSPF external type 1, E2 - OSPF external type 2
       i - IS-IS, L1 - IS-IS level-1, L2 - IS-IS level-2, ia - IS-IS inter area
       Dc - DHCP Client
       [*] - [AD/Metric]
       * - candidate default

C       10.10.10.0/24 is directly connected, eth-0-17
C       10.10.10.10/32 is in local loopback, eth-0-17
O IA    10.10.11.0/24 [110/2] via 10.10.10.11, eth-0-17, 00:00:04
```

Switch2:

```
Switch# show ip route
Codes: K - kernel, C - connected, S - static, R - RIP, B - BGP
       O - OSPF, IA - OSPF inter area
       N1 - OSPF NSSA external type 1, N2 - OSPF NSSA external type 2
       E1 - OSPF external type 1, E2 - OSPF external type 2
       i - IS-IS, L1 - IS-IS level-1, L2 - IS-IS level-2, ia - IS-IS inter area
       Dc - DHCP Client
       [*] - [AD/Metric]
       * - candidate default

C       10.10.10.0/24 is directly connected, eth-0-13
C       10.10.10.11/32 is in local loopback, eth-0-13
C       10.10.11.0/24 is directly connected, eth-0-21
C       10.10.11.11/32 is in local loopback, eth-0-21
```

Switch3:

```
Switch# show ip route
Codes: K - kernel, C - connected, S - static, R - RIP, B - BGP
       O - OSPF, IA - OSPF inter area
       N1 - OSPF NSSA external type 1, N2 - OSPF NSSA external type 2
       E1 - OSPF external type 1, E2 - OSPF external type 2
       i - IS-IS, L1 - IS-IS level-1, L2 - IS-IS level-2, ia - IS-IS inter area
       Dc - DHCP Client
       [*] - [AD/Metric]
       * - candidate default

C       10.10.10.0/24 is directly connected, eth-0-9
C       10.10.10.13/32 is in local loopback, eth-0-9
O IA    10.10.11.0/24 [110/2] via 10.10.10.11, eth-0-9, 00:06:29
```

Switch4:

```
Switch# show ip route
Codes: K - kernel, C - connected, S - static, R - RIP, B - BGP
       O - OSPF, IA - OSPF inter area
       N1 - OSPF NSSA external type 1, N2 - OSPF NSSA external type 2
       E1 - OSPF external type 1, E2 - OSPF external type 2
       i - IS-IS, L1 - IS-IS level-1, L2 - IS-IS level-2, ia - IS-IS inter area
```



```

Dc - DHCP Client
[*] - [AD/Metric]
* - candidate default
Gateway of last resort is 10.10.11.11 to network 0.0.0.0
O*IA   0.0.0.0/0 [110/2] via 10.10.11.11, eth-0-21, 00:12:46
C      10.10.10.0/24 is directly connected, eth-0-21
C      10.10.10.12/32 is in local loopback, eth-0-21

```

Redistributing Routes into OSPF

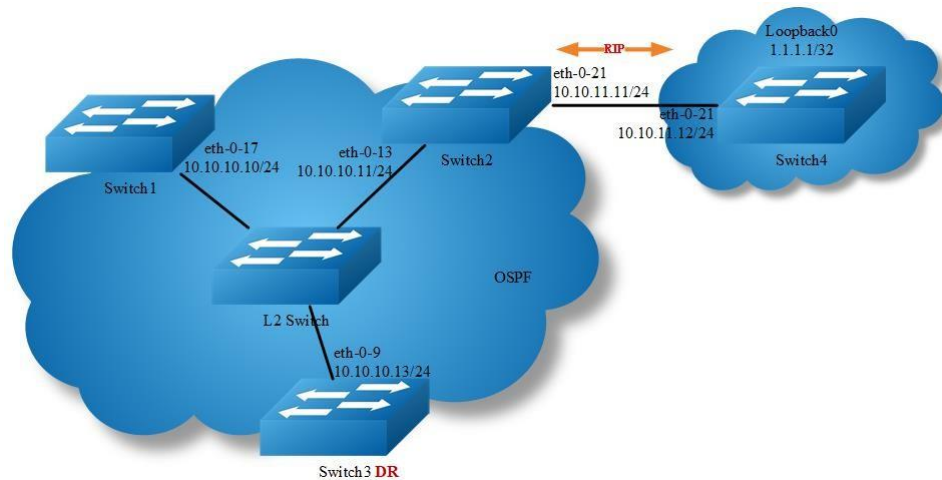

Figure 5-14 ospf redistribute

In this example the configuration causes RIP routes to be imported into the OSPF routing table and advertised as Type 5 External LSAs into Area 0.

step 1 Enter the configure mode

```
Switch# configure terminal
```

step 2 Enter the interface configure mode, set the attributes and ip address

Configure on Switch1:

```
Switch(config)# interface eth-0-17
Switch(config-if)# no switchport
Switch(config-if)# no shutdown
Switch(config-if)# ip address 10.10.10.10/24
Switch(config-if)# quit
```

Configure on Switch2:

```
Switch(config)# interface eth-0-13
Switch(config-if)# no switchport
Switch(config-if)# no shutdown
Switch(config-if)# ip address 10.10.10.11/24
```

```
Switch(config-if)# quit

Switch(config)# interface eth-0-21
Switch(config-if)# no switchport
Switch(config-if)# no shutdown
Switch(config-if)# ip address 10.10.11.11/24
Switch(config-if)# quit
```

Configure on Switch3:

```
Switch(config)# interface eth-0-9
Switch(config-if)# no switchport
Switch(config-if)# no shutdown
Switch(config-if)# ip address 10.10.10.13/24
Switch(config-if)# quit
```

Configure on Switch4:

```
Switch(config)# interface eth-0-21
Switch(config-if)# no switchport
Switch(config-if)# no shutdown
Switch(config-if)# ip address 10.10.11.12/24
Switch(config-if)# quit

Switch(config)# interface loopback 0
Switch(config-if)# ip address 1.1.1.1/32
Switch(config-if)# quit
```

Configure on L2 Switch:

```
Switch(config)# interface eth-0-9
Switch(config-if)# no shutdown
Switch(config-if)# quit
Switch(config)# interface eth-0-13
Switch(config-if)# no shutdown
Switch(config-if)# quit
Switch(config)# interface eth-0-17
Switch(config-if)# no shutdown
Switch(config-if)# quit
```

step 3 Set the ospf priority on the interface

Configure on Switch3:

```
Switch(config)# interface eth-0-9
Switch(config-if)# ip ospf priority 10
Switch(config-if)# quit
```

step 4 Configure the Routing process and associate the network with a specified OSPF area

Configure on Switch1:

```
Switch(config)# router ospf 100
Switch(config-router)# network 10.10.10.0/24 area 0
Switch(config-router)# quit
```

Configure on Switch2:

```
Switch(config)# router ospf 100
Switch(config-router)# network 10.10.10.0/24 area 0
Switch(config-router)# redistribute connected
Switch(config-router)# redistribute rip
Switch(config-router)# quit
```

Configure on Switch3:

```
Switch(config)# router ospf 100
Switch(config-router)# network 10.10.10.0/24 area 0
Switch(config-router)# quit
```

step 5 Enable RIP routing process and associate networks

Configure on Switch2:

```
Switch(config)# router rip
Switch(config-router)# network 10.10.11.0/24
Switch(config-router)# redistribute connected
Switch(config-router)# quit
```

Configure on Switch4:

```
Switch(config)# router rip
Switch(config-router)# network 10.10.11.0/24
Switch(config-router)# network 1.1.1.1/32
Switch(config-router)# redistribute connected
Switch(config-router)# quit
```

step 6 Exit the configure mode

```
Switch(config)# end
```

step 6 Validation

Use the following command to display the ospf routes:

Switch1:

```
Switch# show ip route
Codes: K - kernel, C - connected, S - static, R - RIP, B - BGP
       O - OSPF, IA - OSPF inter area
       N1 - OSPF NSSA external type 1, N2 - OSPF NSSA external type 2
       E1 - OSPF external type 1, E2 - OSPF external type 2
       i - IS-IS, L1 - IS-IS level-1, L2 - IS-IS level-2, ia - IS-IS inter area
       Dc - DHCP Client
```

```

[*] - [AD/Metric]
* - candidate default

O E2    1.1.1.1/32 [110/20] via 10.10.10.11, eth-0-17, 00:01:54
C       10.10.10.0/24 is directly connected, eth-0-17
C       10.10.10.10/32 is in local loopback, eth-0-17
O E2    10.10.11.0/24 [110/20] via 10.10.10.11, eth-0-17, 00:03:49

```

Switch2:

```

Switch# show ip route
Codes: K - kernel, C - connected, S - static, R - RIP, B - BGP
O - OSPF, IA - OSPF inter area
N1 - OSPF NSSA external type 1, N2 - OSPF NSSA external type 2
E1 - OSPF external type 1, E2 - OSPF external type 2
i - IS-IS, L1 - IS-IS level-1, L2 - IS-IS level-2, ia - IS-IS inter area
Dc - DHCP Client
[*] - [AD/Metric]
* - candidate default

R       1.1.1.1/32 [120/2] via 10.10.11.12, eth-0-21, 00:02:27
C       10.10.10.0/24 is directly connected, eth-0-13
C       10.10.10.11/32 is in local loopback, eth-0-13
C       10.10.11.0/24 is directly connected, eth-0-21
C       10.10.11.11/32 is in local loopback, eth-0-21

```

Switch3:

```

Switch# show ip route
Codes: K - kernel, C - connected, S - static, R - RIP, B - BGP
O - OSPF, IA - OSPF inter area
N1 - OSPF NSSA external type 1, N2 - OSPF NSSA external type 2
E1 - OSPF external type 1, E2 - OSPF external type 2
i - IS-IS, L1 - IS-IS level-1, L2 - IS-IS level-2, ia - IS-IS inter area
Dc - DHCP Client
[*] - [AD/Metric]
* - candidate default

O E2    1.1.1.1/32 [110/20] via 10.10.10.11, eth-0-9, 00:03:01
C       10.10.10.0/24 is directly connected, eth-0-9
C       10.10.10.13/32 is in local loopback, eth-0-9
O E2    10.10.11.0/24 [110/20] via 10.10.10.11, eth-0-9, 00:04:57

```

Switch4:

```

Switch# show ip route
Codes: K - kernel, C - connected, S - static, R - RIP, B - BGP
O - OSPF, IA - OSPF inter area
N1 - OSPF NSSA external type 1, N2 - OSPF NSSA external type 2
E1 - OSPF external type 1, E2 - OSPF external type 2
i - IS-IS, L1 - IS-IS level-1, L2 - IS-IS level-2, ia - IS-IS inter area
Dc - DHCP Client
[*] - [AD/Metric]
* - candidate default

```

```
C    1.1.1.1/32 is directly connected, loopback0
R    10.10.10.0/24 [120/2] via 10.10.11.11, eth-0-21, 00:17:36
C    10.10.11.0/24 is directly connected, eth-0-21
C    10.10.11.12/32 is in local loopback, eth-0-21
```

Use the following command to display the database of ospf:

Switch1:

```
Switch# show ip ospf database external

          OSPF Router with ID (10.10.10.10) (Process ID 100)

          AS External Link States

LS age: 317
Options: 0x2 (*|-|-|-|-|E|-)
LS Type: AS-external-LSA
Link State ID: 1.1.1.1 (External Network Number)
Advertising Router: 10.10.10.11
LS Seq Number: 80000001
Checksum: 0x4a47
Length: 36
Network Mask: /32
    Metric Type: 2 (Larger than any link state path)
    TOS: 0
    Metric: 20
    Forward Address: 0.0.0.0
    External Route Tag: 0

LS age: 438
Options: 0x2 (*|-|-|-|-|E|-)
LS Type: AS-external-LSA
Link State ID: 10.10.11.0 (External Network Number)
Advertising Router: 10.10.10.11
LS Seq Number: 80000001
Checksum: 0x0472
Length: 36
Network Mask: /24
    Metric Type: 2 (Larger than any link state path)
    TOS: 0
    Metric: 20
    Forward Address: 0.0.0.0
    External Route Tag: 0
```

Switch2:

```
Switch# show ip ospf database external

          OSPF Router with ID (10.10.10.11) (Process ID 100)

          AS External Link States

LS age: 367
Options: 0x2 (*|-|-|-|-|E|-)
```

```

LS Type: AS-external-LSA
Link State ID: 1.1.1.1 (External Network Number)
Advertising Router: 10.10.10.11
LS Seq Number: 80000001
Checksum: 0x4a47
Length: 36
Network Mask: /32
    Metric Type: 2 (Larger than any link state path)
    TOS: 0
    Metric: 20
    Forward Address: 0.0.0.0
    External Route Tag: 0

LS age: 487
Options: 0x2 (*|-|-|-|-|E|-)
LS Type: AS-external-LSA
Link State ID: 10.10.11.0 (External Network Number)
Advertising Router: 10.10.10.11
LS Seq Number: 80000001
Checksum: 0x0472
Length: 36
Network Mask: /24
    Metric Type: 2 (Larger than any link state path)
    TOS: 0
    Metric: 20
    Forward Address: 0.0.0.0
    External Route Tag: 0

```

Switch3:

```

Switch# show ip ospf database external

        OSPF Router with ID (10.10.10.13) (Process ID 100)

        AS External Link States

LS age: 396
Options: 0x2 (*|-|-|-|-|E|-)
LS Type: AS-external-LSA
Link State ID: 1.1.1.1 (External Network Number)
Advertising Router: 10.10.10.11
LS Seq Number: 80000001
Checksum: 0x4a47
Length: 36
Network Mask: /32
    Metric Type: 2 (Larger than any link state path)
    TOS: 0
    Metric: 20
    Forward Address: 0.0.0.0
    External Route Tag: 0

LS age: 517
Options: 0x2 (*|-|-|-|-|E|-)
LS Type: AS-external-LSA
Link State ID: 10.10.11.0 (External Network Number)

```

```

Advertising Router: 10.10.10.11
LS Seq Number: 80000001
Checksum: 0x0472
Length: 36
Network Mask: /24
    Metric Type: 2 (Larger than any link state path)
    TOS: 0
    Metric: 20
    Forward Address: 0.0.0.0
    External Route Tag: 0

```

OSPF Cost

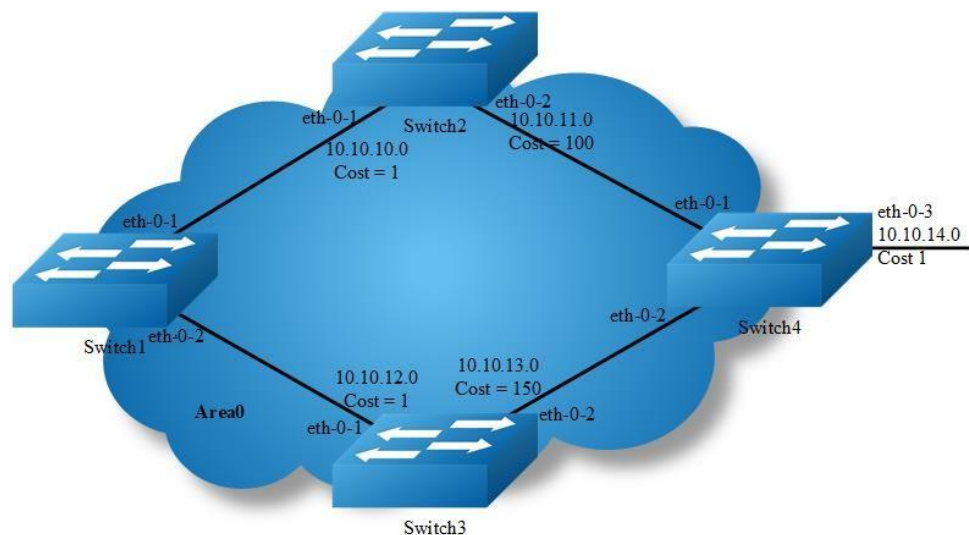

Figure 5-15 ospf cost

You can make a route the preferred route by changing its cost. In this example, cost has been configured to make Switch2 the next hop for Switch1.

The default cost on each interface is 1(1000M speed). Interface eth2 on Switch2 has a cost of 100 and interface eth2 on Switch3 has a cost of 150. The total cost to reach(Switch4 network 10.10.14.0) through Switch2 and Switch3:

Switch2: $1+1+100 = 102$

Switch3: $1+1+150 = 152$

Therefore, Switch1 chooses Switch2 as its next hop for destination Switch4

step 1 Enter the configure mode

```
Switch# configure terminal
```

step 2 Enter the interface configure mode, set the attributes and ip address. Set the ospf cost under the interface configure mode

Configure on Switch1:

```
Switch(config)# interface eth-0-1
Switch(config-if)# no switchport
Switch(config-if)# ip address 10.10.10.1/24
Switch(config-if)# exit
Switch(config)# interface eth-0-2
Switch(config-if)# no switchport
Switch(config-if)# ip address 10.10.12.1/24
Switch(config-if)# exit
```

Configure on Switch2:

```
Switch(config)# interface eth-0-1
Switch(config-if)# no switchport
Switch(config-if)# ip address 10.10.10.2/24
Switch(config-if)# exit
Switch(config)# interface eth-0-2
Switch(config-if)# no switchport
Switch(config-if)# ip address 10.10.11.2/24
Switch(config-if)# ip ospf cost 100
Switch(config-if)# exit
```

Configure on Switch3:

```
Switch(config)# interface eth-0-1
Switch(config-if)# no switchport
Switch(config-if)# ip address 10.10.12.2/24
Switch(config-if)# exit
Switch(config)# interface eth-0-2
Switch(config-if)# no switchport
Switch(config-if)# ip address 10.10.13.2/24
Switch(config-if)# ip ospf cost 150
Switch(config-if)# exit
```

Configure on Switch4:

```
Switch(config)# interface eth-0-1
Switch(config-if)# no switchport
Switch(config-if)# ip address 10.10.11.1/24
Switch(config-if)# exit
Switch(config)# interface eth-0-2
Switch(config-if)# no switchport
Switch(config-if)# ip address 10.10.13.1/24
Switch(config-if)# exit
Switch(config)# interface eth-0-3
Switch(config-if)# no switchport
Switch(config-if)# ip address 10.10.14.1/24
Switch(config-if)# exit
```

step 3 Configure the Routing process and associate the network with a specified OSPF area

Configure on Switch1:

```
Switch(config)# router ospf 100
Switch(config-router)# network 10.10.10.0/24 area 0
Switch(config-router)# network 10.10.12.0/24 area 0
Switch(config-router)# exit
```

Configure on Switch2:

```
Switch(config)# router ospf 100
Switch(config-router)# network 10.10.10.0/24 area 0
Switch(config-router)# network 10.10.11.0/24 area 0
Switch(config-router)# exit
```

Configure on Switch3:

```
Switch(config)# router ospf 100
Switch(config-router)# network 10.10.12.0/24 area 0
Switch(config-router)# network 10.10.13.0/24 area 0
Switch(config-router)# exit
```

Configure on Switch4:

```
Switch(config)# router ospf 100
Switch(config-router)# network 10.10.11.0/24 area 0
Switch(config-router)# network 10.10.13.0/24 area 0
Switch(config-router)# network 10.10.14.0/24 area 0
Switch(config-router)# exit
```

step 4 Exit the configure mode

```
Switch(config)# end
```

step 5 Validation

Use the following command to display the ospf routes:

Switch1:

```
Switch# show ip ospf route
OSPF process 0:
Codes: C - connected, D - Discard, O - OSPF, IA - OSPF inter area
       N1 - OSPF NSSA external type 1, N2 - OSPF NSSA external type 2
       E1 - OSPF external type 1, E2 - OSPF external type 2
C 10.10.10.0/24 [1] is directly connected, eth-0-1, Area 0
O 10.10.11.0/24 [101] via 10.10.10.2, eth-0-1, Area 0
C 10.10.12.0/24 [1] is directly connected, eth-0-2, Area 0
O 10.10.13.0/24 [102] via 10.10.10.2, eth-0-1, Area 0
O 10.10.14.0/24 [102] via 10.10.10.2, eth-0-1, Area 0
```

Switch2:

```
Switch# show ip ospf route
OSPF process 100:
Codes: C - connected, D - Discard, O - OSPF, IA - OSPF inter area
       N1 - OSPF NSSA external type 1, N2 - OSPF NSSA external type 2
       E1 - OSPF external type 1, E2 - OSPF external type 2
C 10.10.10.0/24 [10] is directly connected, eth-0-1, Area 0
C 10.10.11.0/24 [100] is directly connected, eth-0-2, Area 0
O 10.10.12.0/24 [11] via 10.10.10.1, eth-0-1, Area 0
O 10.10.13.0/24 [101] via 10.10.11.1, eth-0-2, Area 0
O 10.10.14.0/24 [101] via 10.10.11.1, eth-0-2, Area 0
```

Switch3:

```
Switch# show ip ospf route
OSPF process 100:
Codes: C - connected, D - Discard, O - OSPF, IA - OSPF inter area
       N1 - OSPF NSSA external type 1, N2 - OSPF NSSA external type 2
       E1 - OSPF external type 1, E2 - OSPF external type 2
O 10.10.10.0/24 [1] via 10.10.12.1, eth-0-1, Area 0
O 10.10.11.0/24 [101] via 10.10.12.1, eth-0-1, Area 0
C 10.10.12.0/24 [1] is directly connected, eth-0-1, Area 0
O 10.10.13.0/24 [102] via 10.10.12.1, eth-0-1, Area 0
O 10.10.14.0/24 [102] via 10.10.12.1, eth-0-1, Area 0
```

Switch4:

```
Switch# show ip route
Codes: K - kernel, C - connected, S - static, R - RIP, B - BGP
       O - OSPF, IA - OSPF inter area
       N1 - OSPF NSSA external type 1, N2 - OSPF NSSA external type 2
       E1 - OSPF external type 1, E2 - OSPF external type 2
       i - IS-IS, L1 - IS-IS level-1, L2 - IS-IS level-2, ia - IS-IS inter area
       [*] - [AD/Metric]
       * - candidate default
O 10.10.10.0/24 [110/1] via 10.10.11.2, eth-0-1, 00:06:27
C 10.10.11.0/24 is directly connected, eth-0-1
O 10.10.12.0/24 [110/1] via 10.10.13.2, eth-0-2, 00:06:17
C 10.10.13.0/24 is directly connected, eth-0-2
C 10.10.14.0/24 is directly connected, eth-0-3
```

Configuring OSPF authentications

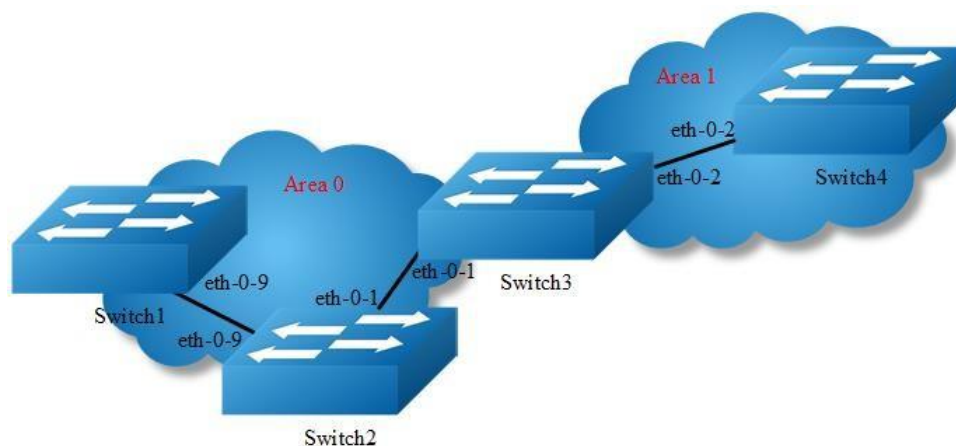

Figure 5-16 ospf authentication

In our implementation there are three types of OSPF authentications--Null authentication (Type 0), Simple Text (Type 1) authentication and MD5 (Type 2) authentication. With null authentication, routing exchanges over the network are not authenticated. In Simple Text authentication, the authentication type is the same for all routers that communicate using OSPF in a network. For MD5 authentication, you configure a key and a key-id on each router. The router generates a message digest on the basis of the key, key ID and the OSPF packet and adds it to the OSPF packet.

The Authentication type can be configured on a per-interface basis or a per-area basis. Additionally, Interface and Area authentication can be used together. Area authentication is used for an area and interface authentication is used for a specific interface in the area. If the Interface authentication type is different from Area authentication type, Interface authentication type overrides the Area authentication type. If the Authentication type is not specified for an interface, the Authentication type for the area is used. The authentication command descriptions contain details of each type of authentication. Refer to the OSPF Command Reference for OSPF authentication commands.

In the example below, Switch1 and B are configured for both the interface and area authentications. The authentication type of interface eth-0-9 on Switch1 and interface eth-0-9 on Switch2 is null authentication mode The authentication type of interface eth-0-1 on Switch2 and interface eth-0-1 on Switch3 is simple authentication mode The authentication type of interface eth-0-2 on Switch3 and

interface eth-0-2 on Switch4 is MD5 authentication mode in area1,if you define area 1 authentication type first, you needn't define interface authentication type, only define authentication key value.

step 1 Enter the configure mode

```
Switch# configure terminal
```

step 2 Enter the interface configure mode, set the attributes and ip address. Set the ospf authentication under the interface configure mode

Configure on Switch1:

```
Switch(config)#interface eth-0-9
Switch(config-if)#no switchport
Switch(config-if)#ip address 9.9.9.1/24
Switch(config-if)#ip ospf authentication
Switch(config-if)#ip ospf authentication null
Switch(config-if)# exit
```

Configure on Switch2:

```
Switch(config)#interface eth-0-1
Switch(config-if)#no switchport
Switch(config-if)#ip address 1.1.1.1/24
Switch(config-if)#ip ospf authentication
Switch(config-if)#ip ospf authentication-key test
Switch(config-if)# exit

Switch(config)#interface eth-0-9
Switch(config-if)#no switchport
Switch(config-if)#ip address 9.9.9.2/24
Switch(config-if)#ip ospf authentication
Switch(config-if)#ip ospf authentication null
Switch(config-if)# exit
```

Configure on Switch3:

```
Switch(config)#interface eth-0-2
Switch(config-if)#no switchport
Switch(config-if)#ip address 2.2.2.1/24
Switch(config-if)# ip ospf message-digest-key 2 md5 ospf
Switch(config-if)# exit

Switch(config)#interface eth-0-1
Switch(config-if)#no switchport
Switch(config-if)#ip address 1.1.1.2/24
Switch(config-if)#ip ospf authentication
Switch(config-if)# ip ospf authentication-key test
Switch(config-if)# exit
```

Configure on Switch4:

```
Switch(config)#interface eth-0-2
Switch(config-if)#no switchport
Switch(config-if)#ip address 2.2.2.2/24
Switch(config-if)# ip ospf message-digest-key 2 md5 ospf
Switch(config-if)# exit
```

step 3 Configure the Routing process and associate the network with a specified OSPF area

Configure on Switch1:

```
Switch(config)# router ospf
Switch(config-router)# network 9.9.9.0/24 area 0
Switch(config-router)# exit
```

Configure on Switch2:

```
Switch(config)# router ospf
Switch(config-router)# network 9.9.9.0/24 area 0
Switch(config-router)# network 1.1.1.0/24 area 0
Switch(config-router)# exit
```

Configure on Switch3:

```
Switch(config)# router ospf
Switch(config-router)# area 1 authentication message-digest
Switch(config-router)# network 2.2.2.0/24 area 1
Switch(config-router)# network 1.1.1.0/24 area 0
Switch(config-router)# exit
```

Configure on Switch4:

```
Switch(config)# router ospf
Switch(config-router)# area 1 authentication message-digest
Switch(config-router)# network 2.2.2.0/24 area 1
Switch(config-router)# exit
```

step 4 Exit the configure mode

```
Switch(config)# end
```

step 5 Validation

Use the following command to display the neighbor of ospf:

Switch1:

```
Switch# show ip ospf neighbor
OSPF process 0:
Neighbor ID      Pri   State           Dead Time   Address        Interface
9.9.9.2          1    Full/DR         00:00:38   9.9.9.2        eth-0-9
```

Switch2:

```
Switch# show ip ospf neighbor
OSPF process 0:
Neighbor ID      Pri   State           Dead Time   Address      Interface
2.2.2.1          1    Full/Backup     00:00:35   1.1.1.2     eth-0-1
1.1.1.1          1    Full/Backup     00:00:38   9.9.9.1     eth-0-9
```

Switch3:

```
Switch# show ip ospf neighbor
OSPF process 0:
Neighbor ID      Pri   State           Dead Time   Address      Interface
9.9.9.2          1    Full/DR         00:00:35   1.1.1.1     eth-0-1
2.2.2.2          1    Full/DR         00:00:38   2.2.2.2     eth-0-2
```

Switch4:

```
Switch# show ip ospf neighbor
OSPF process 0:
Neighbor ID      Pri   State           Dead Time   Address      Interface
2.2.2.1          1    Full/Backup     00:00:35   2.2.2.1     eth-0-2
```

Use the following command to display the interface of ospf:

Switch3:

```
Switch# show ip ospf interface
eth-0-1 is up, line protocol is up
  Internet Address 1.1.1.2/24, Area 0, MTU 1500
  Process ID 0, Router ID 2.2.2.1, Network Type BROADCAST, Cost: 1
  Transmit Delay is 1 sec, State Backup, Priority 1, TE Metric 1
  Designated Router (ID) 9.9.9.2, Interface Address 1.1.1.1
  Backup Designated Router (ID) 2.2.2.1, Interface Address 1.1.1.2
  Timer intervals configured, Hello 10, Dead 40, Wait 40, Retransmit 5
    Hello due in 00:00:01
  Neighbor Count is 1, Adjacent neighbor count is 1
  Crypt Sequence Number is 1301244696
  Hello received 385 sent 384, DD received 3 sent 5
  LS-Req received 1 sent 1, LS-Upd received 11 sent 14
  LS-Ack received 12 sent 10, Discarded 1
  Simple password authentication enabled
```

Use the following command to display the protocol state of ospf process:

Switch3:

```
Switch# show ip ospf
Routing Process "ospf 0" with ID 2.2.2.1
Process uptime is 1 hour 7 minutes
Process bound to VRF default
Conforms to RFC2328, and RFC1583 Compatibility flag is disabled
Supports only single TOS(TOS0) routes
Supports opaque LSA
This router is an ABR, ABR Type is Alternative Cisco (RFC3509)
```

```
SPF schedule delay 5 secs, Hold time between two SPFs 10 secs
Refresh timer 10 secs
Number of incoming current DD exchange neighbors 0/5
Number of outgoing current DD exchange neighbors 0/5
Number of external LSA 0. Checksum 0x000000
Number of opaque AS LSA 0. Checksum 0x000000
Number of non-default external LSA 0
External LSA database is unlimited.
Number of LSA originated 17
Number of LSA received 57
Number of areas attached to this router: 2
  Area 0 (BACKBONE)
    Number of interfaces in this area is 1(1)
    Number of fully adjacent neighbors in this area is 1
    Area has no authentication
    SPF algorithm last executed 01:06:56.340 ago
    SPF algorithm executed 16 times
    Number of LSA 6. Checksum 0x034b09
  Area 1
    Number of interfaces in this area is 1(1)
    Number of fully adjacent neighbors in this area is 1
    Number of fully adjacent virtual neighbors through this area is 0
    Area has message digest authentication
    SPF algorithm last executed 00:03:29.430 ago
    SPF algorithm executed 17 times
    Number of LSA 5. Checksum 0x0230e3
```

5.3.3 Application cases

N/A

Configuring OSPF authentications password encryption

When we configure the OSPF authentication, the authentication-key is simple words.

Thus, the authentication-key is shown as simple words in system. In order to increase the safety of our system, the OSPF authentication-key is shown as encryption words.

Additionally, the system now supports configuring OSPF authentication with encryption words.

Simple Password

step 1 Enter the configure mode

```
Switch# configure terminal
```

step 2 Enter the interface configure mode, set the attributes and ip address. Set the ospf authentication under the interface configure mode and simple password

```
Switch(config)#interface eth-0-9
Switch(config-if)#no switchport
Switch(config-if)#ip address 9.9.9.1/24
Switch(config-if)#ip ospf authentication
Switch(config-if)#ip ospf authentication-key test
Switch(config-if)# exit
```

step 3 Enter the configure mode, translate to encryption password and show it

```
Switch(config)# service password-encryption
Switch(config)# show running-config
!
service password-encryption
!
interface eth-0-9
no switchport
ip address 9.9.9.1/24
ip ospf authentication-key 8 af0443346357baf8
!
```

step 4 Disable the function of showing encryption password, delete the old authentication-key and set new one, then show the password

```
Switch(config)#no service password-encryption
Switch(config)#interface eth-0-9
Switch(config-if)#no ip ospf authentication-key
Switch(config-if)#ip ospf authentication-key test123
Switch(config-if)# exit
Switch(config)# show running-config
!
no service password-encryption
!
interface eth-0-9
no switchport
ip address 9.9.9.1/24
ip ospf authentication-key test123
!
```

step 5 Configuring OSPF encryption password

```
Switch(config)#interface eth-0-9
Switch(config-if)#no ip ospf authentication-key
Switch(config-if)#ip ospf authentication-key 8 af0443346357baf8
Switch(config-if)# exit
Switch(config)# show running-config
!
no service password-encryption
!
interface eth-0-9
no switchport
ip address 9.9.9.1/24
```



```
ip ospf authentication-key test123
!
```

MD5 Password

step 1 Enter the configure mode

```
Switch# configure terminal
```

step 2 Enter the interface configure mode, set the attributes and ip address. Set the ospf authentication under the interface configure mode and simple password

```
Switch(config)#interface eth-0-9
Switch(config-if)#no switchport
Switch(config-if)#ip address 9.9.9.1/24
Switch(config-if)#ip ospf authentication message-digest
Switch(config-if)#ip ospf message-digest-key 1 md5 ospf
Switch(config-if)# exit
```

step 3 Enter the configure mode, translate to encryption password and show it

```
Switch(config)# service password-encryption
Switch(config)# show running-config
!
service password-encryption
!
interface eth-0-9
no switchport
ip address 9.9.9.1/24
ip ospf authentication message-digest
ip ospf message-digest-key 1 md5 8 1f0276567f2db31f
!
```

step 4 Disable the function of showing encryption password, delete the old authentication-key and set new one, then show the password

```
Switch(config)#no service password-encryption
Switch(config)#interface eth-0-9
Switch(config-if)#no ip ospf message-digest-key 1
Switch(config-if)#ip ospf message-digest-key 1 md5 ospf123
Switch(config-if)# exit
Switch(config)# show running-config
!
no service password-encryption
!
interface eth-0-9
no switchport
ip address 9.9.9.1/24
ip ospf authentication message-digest
ip ospf message-digest-key 1 md5 ospf123
!
```

step 5 Configuring OSPF encryption password

```
Switch(config)#interface eth-0-9
Switch(config-if)#no ip ospf message-digest-key 1
Switch(config-if)#ip ospf message-digest-key 1 md5 8 1f0276567f2db31f
Switch(config-if)# exit
Switch(config)# show running-config
!
no service password-encryption
!
interface eth-0-9
no switchport
ip address 9.9.9.1/24
ip ospf authentication message-digest
ip ospf message-digest-key 1 md5 8 1f0276567f2db31f
!
```

5.4 Configuring Prefix-list

5.4.1 Overview

Function Introduction

Routing Policy is the technology for modifying route information to change traffic route. Prefix list is a kind of route policies that used to control and modify routing information. A prefix list is identified by list name and contains one or more ordered entries which are processed sequentially. Each entry provides a matched range for network prefix and has a unique sequence number in the list. In the matching process, switch will check entries orderly. If a entry matches conditions, this process would finish.

Principle Description

N/A

5.4.2 Configuration

Basic Configuration

step 1 Enter the configure mode

```
Switch# configure terminal
```

step 2 Create a prefix-list

Note: Create a prefix-list. If the sequence of the rule is not specified, system should automatically assign an sequence number for it. Support different actions such as permit and deny. Support to add description string for a prefix-list.

```
Switch(config)# ip prefix-list test seq 1 deny 35.0.0.0/8 le 16
Switch(config)# ip prefix-list test permit any
Switch(config)# ip prefix-list test description this prefix list is fot test
Switch(config)# ip prefix-list test permit 36.0.0.0/24
```

step 3 Exit the configure mode

```
Switch(config)# end
```

step 4 Validation

Use the following command to display the prefix-list:

```
Switch# show ip prefix-list detail
Prefix-list list number: 1
Prefix-list entry number: 3
Prefix-list with the last deletion/insertion: test
ip prefix-list test:
  Description: this prefix list is fot test
  count: 3, range entries: 0, sequences: 1 - 10
    seq 1 deny 35.0.0.0/8 le 16 (hit count: 0, refcount: 0)
    seq 5 permit any (hit count: 0, refcount: 0)
    seq 10 permit 36.0.0.0/24 (hit count: 0, refcount: 0)
```

Used by rip

step 1 Enter the configure mode

```
Switch# configure terminal
```

step 2 Create a prefix-list

```
Switch(config)# ip prefix-list aa seq 11 deny 35.0.0.0/8 le 16
Switch(config)# ip prefix-list aa permit any
```

step 3 Apply the prefix-list under the router rip configure mode

```
Switch(config)# router rip
Switch(config-router)# distribute-list prefix aa out
Switch(config-router)# exit
```

step 5 Exit the configure mode

```
Switch(config)# end
```

step 6 Validation

Use the following command to display the prefix-list:

```
Switch# show ip prefix-list
ip prefix-list aa: 2 entries
    seq 11 deny 35.0.0.0/8 le 16
    seq 15 permit any
```

Use the following command to display the configuration of the device:

```
Switch# show running-config
Building configuration...
...
ip prefix-list aa seq 11 deny 35.0.0.0/8 le 16
ip prefix-list aa seq 15 permit any
...
router rip
    distribute-list prefix aa out
```

Used by Route-map

step 1 Enter the configure mode

```
Switch# configure terminal
```

step 2 Create a prefix-list

```
Switch(config)# ip prefix-list aa seq 11 deny 3.3.3.0/8 le 24
Switch(config)# ip prefix-list aa permit any
```

step 3 create a route map to match the prefix-list

```
Switch(config)# route-map abc permit
Switch(config-route-map)# match ip address prefix-list aa
Switch(config-route-map)# set local-preference 200
Switch(config-route-map)# exit

Switch(config)# route-map abc permit 20
Switch(config-route-map)# exit
```

step 4 Apply the route under the router bgp configure mode

```
Switch(config)# router bgp 1
Switch(config-router)# neighbor 1.1.1.2 remote-as 1
```

```
Switch(config-router)# neighbor 1.1.1.2 route-map abc out
Switch(config-router)# network 2.2.2.2/32
Switch(config-router)# network 3.3.3.3/32
```

step 5 Exit the configure mode

```
Switch(config-router)# end
```

step 6 Validation

Use the following command to display the route map:

```
Switch # show route-map
route-map abc, permit, sequence 10
  Match clauses:
    ip address prefix-list aa
  Set clauses:
    local-preference 200
route-map abc, permit, sequence 20
  Match clauses:
Set clauses:
```

Use the following command to display the configuration of the device:

```
Switch # show running-config
Building configuration...
...
ip prefix-list aa seq 11 deny 3.3.3.0/8 le 24
ip prefix-list aa seq 15 permit any
!
!
route-map abc permit 10
  match ip address prefix-list aa
  set local-preference 200
!
route-map abc permit 20
...
router bgp 1
  neighbor 1.1.1.2 remote-as 1
  !
  address-family ipv4
    no synchronization
    network 2.2.2.2 mask 255.255.255.255
    network 3.3.3.3 mask 255.255.255.255
    neighbor 1.1.1.2 activate
    neighbor 1.1.1.2 route-map abc out
    exit-address-family
  !
  address-family vpv4 unicast
    no synchronization
    exit-address-family
```

5.4.3 Application cases

N/A

5.5 Configuring Route-map

5.5.1 Overview

Function Introduction

Route-map is used to control and modify routing information. The route-map command allows redistribution of routes. It has a list of match and set commands associated with it. The match commands specify the conditions under which redistribution is allowed, and the set commands specify the particular redistribution actions to be performed if the criteria enforced by match commands are met. Route maps are used for detailed control over route distribution between routing processes. Route maps also allow policy routing, and might route packets to a different route than the obvious shortest path.

If the permit parameter is specified, and the match criteria are met, the route is redistributed as specified by set actions. If the match criteria are not met, the next route map with the same tag is tested. If the deny parameter is specified, and the match criteria are met, the route is not redistributed, and any other route maps with the same map tag are not examined. Routes are checked from line to line looking for a match. If there is no match and the bottom of the route map is reached, then the router denies the route from being redistributed. There is always an implicit deny at the end of a route map.

Specify the sequence parameter to indicate the position a new route map is to have in the list of route maps already configured with the same name.

Principle Description

N/A

5.5.2 Configuration

Configuring Route-map for OSPF

step 1 Enter the configure mode

```
Switch# configure terminal
```

step 2 Create route map and set the rule and action



NOTE

The name of route-map is up to 20 characters, in this example the name is "abc". Two actions "permit" and "deny" are supported; the default action is "permit". The valid range for sequence number is 1-65535. If the sequence number is not specified when creating first rule of the route-map, system assigns number 10 by default.

```
Switch(config)# route-map abc permit
Switch(config-route-map)# match metric 20
Switch(config-route-map)# set tag 2
Switch(config-route-map)# exit
```

```
Switch(config)# route-map abc permit 20
Switch(config-route-map)# exit
```

step 3 Enter the router ospf configure mode, redistribute rip routes and apply the route map

```
Switch(config)# router ospf 100
Switch(config-router)# redistribute rip route-map abc
Switch(config-router)# exit
```

step 4 Exit the configure mode

```
Switch(config)# end
```

step 5 Validation

```
Switch# show route-map
route-map abc, permit, sequence 10
  Match clauses:
    metric 20
  Set clauses:
    tag 2
route-map abc, permit, sequence 20
```

```
Match clauses:  
Set clauses:
```

Configuring Route-map for BGP

step 1 Enter the configure mode

```
Switch# configure terminal
```

step 2 Create ip access list

```
Switch(config)# ip access-list acl1  
Switch(config-ip-acl)# permit any 3.3.3.0 0.0.0.255 any  
Switch(config-ip-acl)# exit
```

step 3 Create route map to match the access list and set the rule and action

```
Switch(config)# route-map abc permit  
Switch(config-route-map)# match ip address acl1  
Switch(config-route-map)# set local-preference 200  
Switch(config-route-map)# exit  
  
Switch(config)# route-map abc permit 20  
Switch(config-route-map)# exit
```

step 4 Enter the router bgp configure mode, and apply the route map

```
Switch(config)# router bgp 1  
Switch(config-router)# neighbor 1.1.1.2 remote-as 1  
Switch(config-router)# neighbor 1.1.1.2 route-map abc out  
Switch(config-router)# network 2.2.2.2/32  
Switch(config-router)# network 3.3.3.3/32  
Switch(config-router)# exit
```

step 5 Exit the configure mode

```
Switch(config)# end
```

step 6 Validation

```
DUT1# show route-map  
route-map abc, permit, sequence 10  
  Match clauses:  
    ip address acl1  
  Set clauses:  
    local-preference 200  
route-map abc, permit, sequence 20  
  Match clauses:
```



```
Set clauses:
DUT2# show ip bgp
BGP table version is 6, local router ID is 1.1.1.2
Status codes: s suppressed, d damped, h history, * valid, > best, i - internal,
               S Stale
Origin codes: i - IGP, e - EGP, ? - incomplete
   Network          Next Hop          Metric LocPrf Weight Path
*>i2.2.2.2/32      1.1.1.1            0     100     0 i
*>i3.3.3.3/32      1.1.1.1            0     200     0 i
```

5.5.3 Application cases

N/A

5.6 Configuring Policy-Based Routing

5.6.1 Overview

Function Introduction

Policy-Based Routing(PBR) provide freedom to implement packet forwarding and routing, according to the defined policies in a way that goes beyond traditional routing protocol concerns. By using policy-based routing, customers can implement policies that selectively cause packets to take different paths.

Principle Description

N/A

5.6.2 Configuration

PBR Configuration

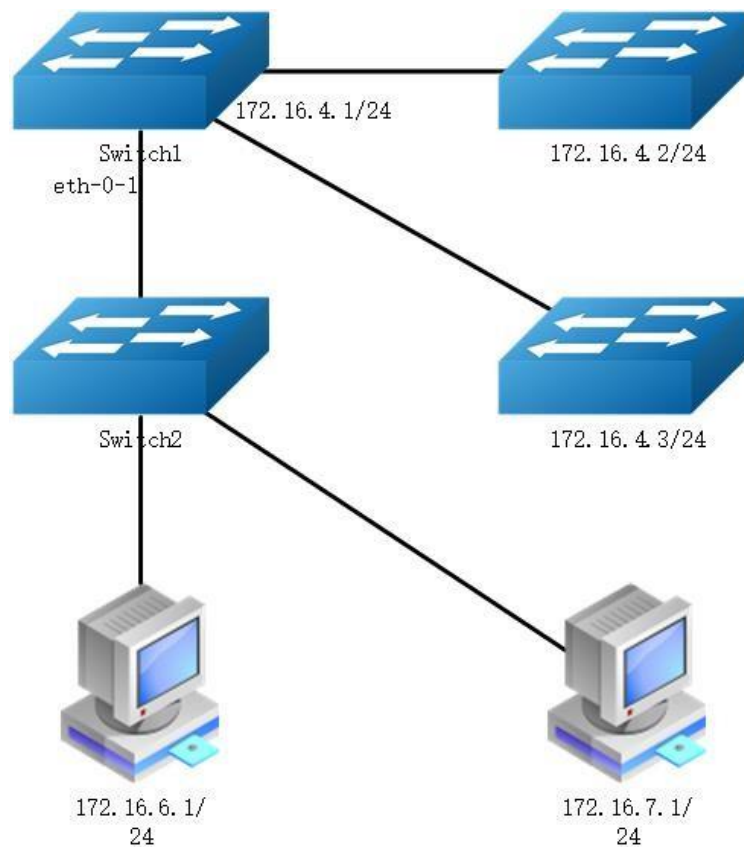

Figure 5-17 pbr

The figure above is a typical topology: After Enabling PBR on interface eth-0-1 of Switch1, packets from 172.16.6.1 should be forwarded to 172.16.4.2, and other packets should be forwarded according to the original routes.

Configure on Switch1:

step 1 Enter the configure mode

```
Switch# configure terminal
```

step 2 Create an ip access list to match source ip address

```
Switch(config)# ip access-list acl1
Switch(config-ip-acl)# 10 permit any 172.16.6.0 0.0.0.255 any
Switch(config-ip-acl)# exit
```

step 3 Create a route map, to match the ip access list and set the nexthop ip

```
Switch(config)# route-map rmap permit 10
Switch(config-route-map)# match ip address acl1
Switch(config-route-map)# set ip next-hop 172.16.4.2
Switch(config-route-map)# exit
```

step 4 Enter the interface configure mode, set the attributes and ip address, and apply the route map

```
Switch(config)# interface eth-0-1
Switch(config-if)# no switchport
Switch(config-if)# ip address 172.16.5.2/24
Switch(config-if)# no shutdown
Switch(config-if)# ip policy route-map rmap
Switch(config-if)# exit
```

step 5 Create a static route with the nexthop ip 172.16.4.3 (optional)

To forwarding the packets which not hit the PBR, we can use a static route. Dynamic protocols such as RIP/OSPF are can also meet this requirement.

```
Switch(config)# ip route 0.0.0.0/0 172.16.4.3
```

step 6 Exit the configure mode

```
Switch(config)# end
```

step 7 Validation

```
Switch# show ip policy route-map
Route-map                interface
rmap                     eth-0-1
```

Configure PBR and BFD linkage

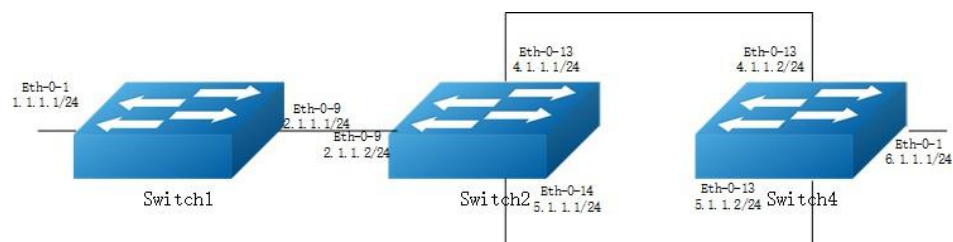

Figure 5-18 pbr

The figure above is a typical topology: Switch2 will forward packet to eth-0-13 according PBR routes, when Switch4 eth-0-13 shutdown, bfd session statuses will be down, then track 1 will be down, and the PBR next-hop 4.1.1.2 will be invalid, packet will forward to eth-0-14.

step 1 Configure on Switch1:

```
Switch1# configure terminal
Switch1(config)# interface eth-0-1
Switch1(config-if)# no shutdown
Switch1(config-if)# no switchport
Switch1(config-if)# ip address 1.1.1.1/24
Switch1(config-if)# interface eth-0-9
Switch1(config-if)# no shutdown
Switch1(config-if)# no switchport
Switch1(config-if)# ip address 2.1.1.1/24
Switch1(config-if)# quit
Switch1(config)# ip route 5.1.1.0/24 2.1.1.2
Switch1(config)# ip route 6.1.1.0/24 2.1.1.2
```

step 2 Configure on Switch2:

```
Switch2# configure terminal
Switch2(config)# ip access-list acl1
Switch2(config-ip-acl)# 10 permit any host 2.1.1.1 any
Switch2(config-ip-acl)# quit
Switch2(config)# route-map rmap permit 10
Switch2(config-route-map)# match ip address acl1
Switch2(config-route-map)# set ip next-hop 4.1.1.2 track 1
Switch2(config-route-map)# quit
Switch2(config)# interface eth-0-9
Switch2(config-if)# no shutdown
Switch2(config-if)# no switchport
Switch2(config-if)# ip address 2.1.1.2/24
Switch2(config-if)# ip policy route-map rmap
Switch2(config-if)# interface eth-0-13
Switch2(config-if)# no shutdown
Switch2(config-if)# no switchport
Switch2(config-if)# ip address 4.1.1.1/24
Switch2(config-if)# interface eth-0-14
Switch2(config-if)# no shutdown
Switch2(config-if)# no switchport
Switch2(config-if)# ip address 5.1.1.1/24
Switch2(config-if)# quit
Switch2(config)# track 1 bfd source interface eth-0-13 destination 4.1.1.2
Switch2(config-track)# quit
Switch2(config)# ip route 1.1.1.0/24 2.1.1.1
Switch2(config)# ip route 6.1.1.0/24 5.1.1.2
```

step 3 Configure on Switch4:

```
Switch4# configure terminal
Switch4(config)# interface eth-0-1
Switch4(config-if)# no shutdown
Switch4(config-if)# no switchport
Switch4(config-if)# ip address 6.1.1.1/24
Switch4(config-if)# interface eth-0-13
Switch4(config-if)# no shutdown
Switch4(config-if)# no switchport
Switch4(config-if)# ip address 4.1.1.2/24
Switch4(config-if)# interface eth-0-14
Switch4(config-if)# no shutdown
Switch4(config-if)# no switchport
Switch4(config-if)# ip address 5.1.1.2/24
Switch4(config-if)# quit
Switch4(config)# track 1 bfd source interface eth-0-13 destination 4.1.1.1
Switch4(config-track)# quit
Switch4(config)# ip route 1.1.1.0/24 5.1.1.1
Switch4(config)# ip route 2.1.1.0/24 5.1.1.1
```

step 3 ping 6.1.1.1 Switch2 will forward packet to eth-0-13

```
Switch1# ping 6.1.1.1
PING 6.1.1.1 (6.1.1.1) 56(84) bytes of data.
64 bytes from 6.1.1.1: icmp_seq=1 ttl=63 time=417 ms
64 bytes from 6.1.1.1: icmp_seq=2 ttl=63 time=428 ms
64 bytes from 6.1.1.1: icmp_seq=3 ttl=63 time=441 ms
64 bytes from 6.1.1.1: icmp_seq=4 ttl=63 time=469 ms
64 bytes from 6.1.1.1: icmp_seq=5 ttl=63 time=461 ms

--- 6.1.1.1 ping statistics ---
5 packets transmitted, 5 received, 0% packet loss, time 6810ms
rtt min/avg/max/mdev = 417.834/443.810/469.720/19.470 ms
```

step 4 shutdown eth-0-13 of Switch4

```
Switch4# configure terminal
Switch4(config)# interface eth-0-13
Switch4(config-if)# shutdown
```

step 5 Validation

```
Switch2# show track
Track 1
  Type           : BFD state
  Source interface : eth-0-13
  Destination IP  : 4.1.1.2
  BFD Local discr : 8192
  rmap           : pref 10 track 1
  State          : down
```

```

Switch2# show bfd session
Abbreviation:
LD: Local Discriminator.  RD: Remote Discriminator
S: Single hop session.    M: Multi hop session.
SD: Static Discriminator. DD: Dynamic Discriminator
SBFD: Seamless BFD
A: Admin down.    D:Down.    I:Init.    U:Up.
=====
LD          RD          TYPE ST  UP-Time  Remote-Addr  Sbfd-Type VRF
-----
8192       0           S-DD D   00:00:00  4.1.1.2     None      default

Number of Sessions:    1
Switch2 will forward packet to eth-0-14
Switch# ping 6.1.1.1
PING 6.1.1.1 (6.1.1.1) 56(84) bytes of data.
64 bytes from 6.1.1.1: icmp_seq=1 ttl=63 time=414 ms
64 bytes from 6.1.1.1: icmp_seq=2 ttl=63 time=432 ms
64 bytes from 6.1.1.1: icmp_seq=3 ttl=63 time=424 ms
64 bytes from 6.1.1.1: icmp_seq=4 ttl=63 time=525 ms
64 bytes from 6.1.1.1: icmp_seq=5 ttl=63 time=437 ms

--- 6.1.1.1 ping statistics ---
5 packets transmitted, 5 received, 0% packet loss, time 6563ms
rtt min/avg/max/mdev = 414.720/446.816/525.276/39.949 ms

```

5.6.3 Application cases

N/A

5.7 Configuring BGP

5.7.1 Overview

Function Introduction

The Border Gateway Protocol (BGP) is an inter-Autonomous System routing protocol.

The primary function of a BGP speaking system is to exchange network reachability information with other BGP systems. This network reachability information includes information on the list of Autonomous Systems (ASes) that reachability information traverses. This information is sufficient for constructing a graph of AS connectivity for this reachability, from which routing loops may be pruned and, at the AS level, some policy decisions may be enforced.

BGP-4 provides a set of mechanisms for supporting Classless Inter-Domain Routing (CIDR) [RFC1518, RFC1519]. These mechanisms include support for advertising a set of destinations as an IP prefix and eliminating the concept of network "class" within BGP. BGP-4 also introduces mechanisms that allow aggregation of routes, including aggregation of AS paths.

Routing information exchanged via BGP supports only the destination-based forwarding paradigm, which assumes that a router forwards a packet based solely on the destination address carried in the IP header of the packet. This, in turn, reflects the set of policy decisions that can (and cannot) be enforced using BGP. BGP can support only those policies conforming to the destination-based forwarding paradigm.

Principle Description

For more BGP information please reference [RFC 1771, RFC 4271].

5.7.2 Configuration

Configure EBGP

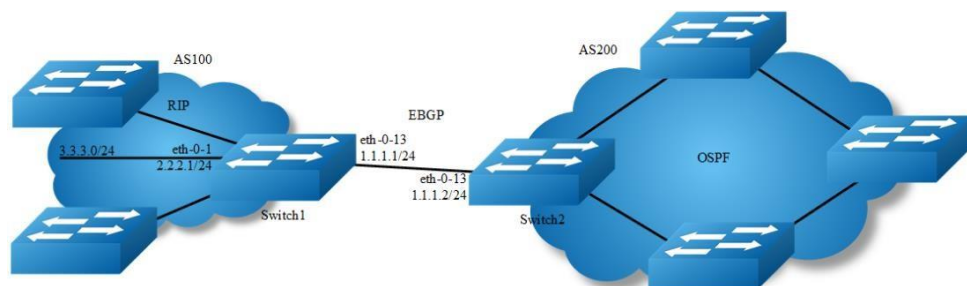

Figure 5-19 EBGP

step 1 Enter the configure mode

```
Switch# configure terminal
```

step 2 Enter the interface configure mode and set the attributes

Switch1:

```
Switch(config)# interface eth-0-13
Switch(config-if)# no shutdown
Switch(config-if)# no switchport
Switch(config-if)# ip address 1.1.1.1/24
```

```
Switch(config-if)# exit

Switch(config)# interface eth-0-1
Switch(config-if)# no shutdown
Switch(config-if)# no switchport
Switch(config-if)# ip address 2.2.2.1/24
Switch(config-if)# exit
```

Switch2:

```
Switch(config)# interface eth-0-13
Switch(config-if)# no shutdown
Switch(config-if)# no switchport
Switch(config-if)# ip address 1.1.1.2/24
Switch(config-if)# exit
```

step 3 Configure a static route

Switch1:

```
Switch(config)# ip route 3.3.3.0/24 2.2.2.2
```

step 4 Configure the Routing process and set the router id, set the neighbor, associate the network, and set the redistribute attributes

Switch1:

```
Switch(config)# router bgp 100
Switch(config-router)# bgp router-id 10.10.10.10
Switch(config-router)# neighbor 1.1.1.2 remote-as 200
Switch(config-router)# neighbor 1.1.1.2 ebgp-multihop
Switch(config-router)# network 4.0.0.0/8
Switch(config-router)# redistribute static
Switch(config-router)# redistribute connected
Switch(config-router)# exit
```

Switch2:

```
Switch(config)# router bgp 200
Switch(config-router)# bgp router-id 11.11.11.11
Switch(config-router)# neighbor 1.1.1.1 remote-as 100
Switch(config-router)# neighbor 1.1.1.1 ebgp-multihop
Switch(config-router)# redistribute connected
Switch(config-router)# exit
```

step 5 Exit the configure mode

```
Switch(config)# end
```

step 6 Validation

Switch1:

```
Switch# show ip bgp neighbors
BGP neighbor is 1.1.1.2, remote AS 200, local AS 100, external link
  BGP version 4, remote router ID 0.0.0.0
  BGP state = Active
  Last read 00:26:00, hold time is 180, keepalive interval is 60 seconds
  Received 0 messages, 0 notifications, 0 in queue
  Sent 0 messages, 0 notifications, 0 in queue
  Route refresh request: received 0, sent 0
  Minimum time between advertisement runs is 30 seconds
For address family: IPv4 Unicast
  BGP table version 1, neighbor version 0
  Index 1, Offset 0, Mask 0x2
  0 accepted prefixes
  0 announced prefixes
Connections established 0; dropped 0
  External BGP neighbor may be up to 255 hops away.
Next connect timer due in 87 seconds
```

Switch2:

```
SwitchB# show ip bgp neighbors
BGP neighbor is 1.1.1.1, remote AS 100, local AS 200, external link
  BGP version 4, remote router ID 0.0.0.0
  BGP state = Active
  Last read 00:21:39, hold time is 180, keepalive interval is 60 seconds
  Received 0 messages, 0 notifications, 0 in queue
  Sent 0 messages, 0 notifications, 0 in queue
  Route refresh request: received 0, sent 0
  Minimum time between advertisement runs is 30 seconds
For address family: IPv4 Unicast
  BGP table version 1, neighbor version 0
  Index 1, Offset 0, Mask 0x2
  0 accepted prefixes
  0 announced prefixes
Connections established 0; dropped 0
  External BGP neighbor may be up to 255 hops away.
Next connect timer due in 97 seconds
```

Configure IBGP

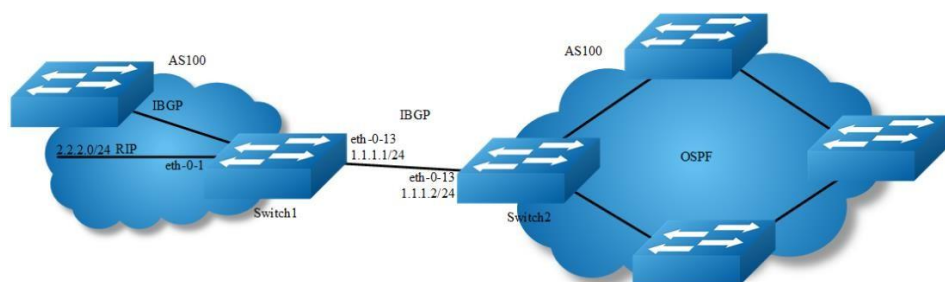

Figure 5-20 IBGP**step 1 Enter the configure mode**

```
Switch# configure terminal
```

step 2 Enter the interface configure mode and set the attributes**Switch1:**

```
Switch(config)# interface eth-0-1
Switch(config-if)# no shutdown
Switch(config-if)# no switchport
Switch(config-if)# ip address 2.2.2.1/24
Switch(config-if)# exit

Switch(config)# interface eth-0-13
Switch(config-if)# no shutdown
Switch(config-if)# no switchport
Switch(config-if)# ip address 1.1.1.1/24
Switch(config-if)# exit

Switch(config)# interface loopback 0
Switch(config-if)# ip address 10.10.10.10/32
Switch(config-if)# exit
```

Switch2:

```
Switch(config)# interface eth-0-13
Switch(config-if)# no shutdown
Switch(config-if)# no switchport
Switch(config-if)# ip address 1.1.1.2/24
Switch(config-if)# exit

Switch(config)# interface loopback 0
Switch(config-if)# ip address 11.11.11.11/32
Switch(config-if)# exit
```

step 3 Configure a static route**Switch1:**

```
Switch (config)# ip route 11.11.11.11/32 1.1.1.2
```

Switch2:

```
Switch (config)# ip route 10.10.10.10/32 1.1.1.1
```

step 4 Configure the Routing process and set the router id, set the neighbor, associate the network, and set the redistribute attributes

Switch1:

```
Switch(config)# router bgp 100
Switch(config-router)# bgp router-id 10.10.10.10
Switch(config-router)# neighbor 11.11.11.11 remote-as 100
Switch(config-router)# neighbor 11.11.11.11 update-source loopback 0
Switch(config-router)# network 4.0.0.0/8
Switch(config-router)# redistribute static
Switch(config-router)# redistribute connected
Switch(config-router)# exit
```

Switch2:

```
Switch(config)# router bgp 100
Switch(config-router)# bgp router-id 11.11.11.11
Switch(config-router)# neighbor 10.10.10.10 remote-as 100
Switch(config-router)# neighbor 10.10.10.10 update-source loopback 0
Switch(config-router)# redistribute connected
Switch(config-router)# exit
```

step 5 Exit the configure mode

```
Switch(config)# end
```

step 6 Validation

Switch1:

```
Switch# show ip bgp neighbors
BGP neighbor is 11.11.11.11, remote AS 100, local AS 100, internal link
  BGP version 4, remote router ID 0.0.0.0
  BGP state = Active
  Last read 00:02:32, hold time is 180, keepalive interval is 60 seconds
  Received 0 messages, 0 notifications, 0 in queue
  Sent 0 messages, 0 notifications, 0 in queue
  Route refresh request: received 0, sent 0
  Minimum time between advertisement runs is 5 seconds
  Update source is loopback0
For address family: IPv4 Unicast
  BGP table version 1, neighbor version 0
  Index 1, Offset 0, Mask 0x2
  0 accepted prefixes
  0 announced prefixes
Connections established 0; dropped 0
Next connect timer due in 62 seconds
```

Switch2:

```
Switch# show ip bgp neighbors
BGP neighbor is 10.10.10.10, remote AS 100, local AS 100, internal link
  BGP version 4, remote router ID 0.0.0.0
  BGP state = Active
  Last read 00:01:58, hold time is 180, keepalive interval is 60 seconds
  Received 0 messages, 0 notifications, 0 in queue
  Sent 0 messages, 0 notifications, 0 in queue
  Route refresh request: received 0, sent 0
  Minimum time between advertisement runs is 5 seconds
  Update source is loopback0
For address family: IPv4 Unicast
  BGP table version 1, neighbor version 0
  Index 1, Offset 0, Mask 0x2
  0 accepted prefixes
  0 announced prefixes
Connections established 0; dropped 0
Next connect timer due in 17 seconds
```

5.7.3 Application cases

N/A

5.8 Configuring ISIS

5.8.1 Overview

Function Introduction

Intermediate System to Intermediate System (ISIS) is a link state routing protocol that uses the shortest path first (SPF) algorithm for routing algorithms. It is actually very similar to OSPF. It also uses Hello protocol to find neighboring nodes and uses a propagation protocol to send link information. ISIS can operate on different subnets, including broadcast LANs, WANs and point-to-point links.

Principle Description

NET

The Network Entity Title (NET) indicates the network layer information of the IS itself, excluding the transport layer information (SEL = 0). It can be regarded as a special kind of NSAP, that is, an NSAP address whose SEL is 0. Therefore, NET is the same length as NSAP, with a maximum of 20 bytes and a minimum of 8 bytes. Generally, a

router can be configured with a NET. When an area needs to be re-divided, for example, multiple areas are combined, or an area is divided into multiple areas. In this case, multiple NETs can be configured during reconfiguration. Still can guarantee the correctness of the route. As a router default can be configured up to three regional addresses, so up to only three NET configuration. When configuring multiple NETs, you must ensure that their System IDs are the same. For example, NET is: ab.cdef.1234.5678.9abc.00, where Area is ab.cdef, System ID is 1234.5678.9abc, and SEL is 00.

ISIS area

1. Two-level structure In order to support large-scale routing networks, IS-IS adopts a two-level hierarchical structure in the routing domain. A large routing domain is divided into one or more Areas. Routes in the area are managed by Level-1 routers and inter-area routes are managed by Level-2 routers.
 - Level-1 and Level-2
 - Level-1 router The Level-1 router is responsible for the intra-area routing. It only establishes the neighbor relationship with the Level-1 and Level-1-2 routers in the same area and maintains a Level-1 LSDB. The Level-1 router contains the routing information of the area. The packet is forwarded to the nearest Level-1-2 router.
 - Level-2 router The Level-2 router is responsible for inter-area routing. It can establish the neighbor relationship with Level-2 and Level-1-2 routers in the same area or other areas and maintains a Level-2 LSDB. The LSDB contains inter-area routing information. All Level-2 routers and Level-1-2 routers form the backbone network in the routing domain and are responsible for communication between different areas. The Level-2 routers in the routing domain must be physically contiguous to ensure continuity of the backbone network. Only Level-2 routers can exchange data packets or routing information with routers outside the routing domain.
 - Level-1-2 router Routers belonging to Level-1 and Level-2 are called Level-1-2 routers. They can establish Level-1 neighbor relationships with Level-1 and Level-1-2 routers in the same area or with Level-1 routers in the same area or with other areas. Level-2 and Level-1-2 routers form a Level-2 neighbor relationship. Level-1 routers must pass through Level-1-2 routers to connect to

other areas. The Level-1-2 router maintains two LSDBs. The Level-1 LSDB is used for intra-area routing. The Level-2 LSDB is used for inter-area routing.

3. The route type of the interface For a router of type Level-1-2, you may need to set up Level-1 adjacency with only one peer and establish only Level-2 adjacency with the other peer. You can set the routing layer type of the corresponding interface to limit the adjacencies that can be established on the interface. For example, Level-1 interfaces can only establish Level-1 adjacencies. Level-2 interfaces can only establish Level-2 adjacencies. For Level-1-2 routers, you can also save bandwidth by preventing Level-1 Hello packets from being sent to the Level-2 backbone network by configuring some interfaces as Level-2.
4. Route infiltration (Route Leaking) Generally, an IS-IS area is also called a Level-1 area. Routes in the area are managed by Level-1 routers. All Level-2 routers form a Level-2 area. Therefore, an IS-IS routing domain can contain multiple Level-1 areas but only one Level-2 area.

5.8.2 Configuration

Basic ISIS Parameters Configuration

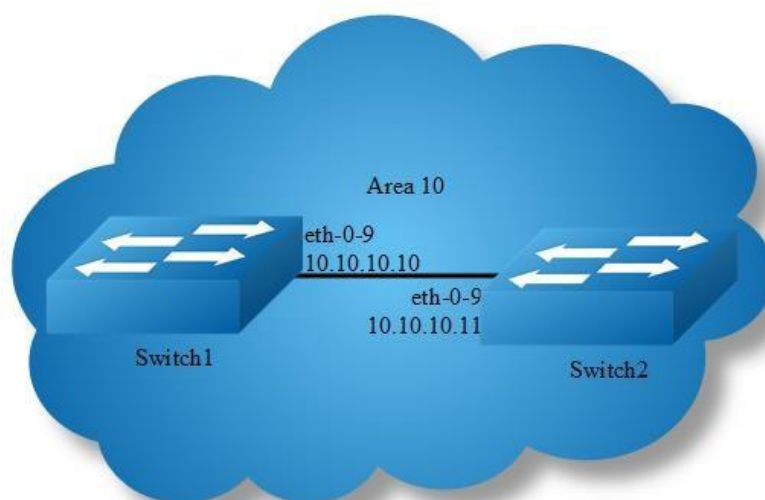

Figure 5-21 RIPng

step 1 Enter the configure mode

```
Switch# configure terminal
```

step 2 Configure the Routing process and set the net

configuration for Switch1:

```
Switch(config)# router isis
Switch(config-router)# net 10.0000.0000.0001.00
Switch(config-router)# exit
```

configuration for Switch2:

```
Switch(config)# router isis
Switch(config-router)# net 10.0000.0000.0002.00
Switch(config-router)# exit
```

step 3 Enable ipv4 isis on the interface

configuration for Switch1:

```
Switch(config)# interface eth-0-9
Switch(config-if)# no switchport
Switch(config-if)# ip address 10.10.10.10/24
Switch(config-if)# ip router isis
Switch(config)# interface loopback 0
Switch(config-if)# ip address 1.1.1.1/32
Switch(config-if)# ip router isis
```

configuration for Switch2:

```
Switch(config)# interface eth-0-9
Switch(config-if)# no switchport
Switch(config-if)# ip address 10.10.10.11/24
Switch(config-if)# ip router isis
Switch(config)# interface loopback 0
Switch(config-if)# ip address 2.2.2.2/32
Switch(config-if)# ip router isis
```

step 4 Validation

Display the result on Switch1:

```
Switch# show clns neighbors

Area (null):
System Id      Interface  SNPA                State  Holdtime  Type Protocol
0000.0000.0002 eth-0-9    4a98.a825.3d00     Up     21        L1   IS-IS
                                     Up     21        L2   IS-IS

Switch# show isis database verbose
Area (null):
IS-IS Level-1 Link State Database:
LSPID          LSP Seq Num  LSP Checksum  LSP Holdtime  ATT/P/OL
0000.0000.0001.00-00* 0x00000004   0x3244        1082          0/0/0
  Area Address: 10
```

```

NLPID:          IPV4
IP Address:     10.10.10.10
Metric:        10          IS 0000.0000.0001.01
Metric:        10          IP 10.10.10.0 255.255.255.0
Metric:        10          IP 1.1.1.1 255.255.255.255
0000.0000.0001.01-00* 0x00000001 0x21B9          895          0/0/0
Metric:        0          IS 0000.0000.0001.00
Metric:        0          IS 0000.0000.0002.00
0000.0000.0002.00-00 0x00000004 0xFA75          1076         0/0/0
Area Address:  10
NLPID:          IPV4
IP Address:     10.10.10.11
Metric:        10          IS 0000.0000.0001.01
Metric:        10          IP 10.10.10.0 255.255.255.0
Metric:        10          IP 2.2.2.2 255.255.255.255

IS-IS Level-2 Link State Database:
LSPID          LSP Seq Num  LSP Checksum  LSP Holdtime  ATT/P/OL
0000.0000.0001.00-00* 0x00000005  0xFCCE        1109          0/0/0
Area Address:  10
NLPID:          IPV4
IP Address:     10.10.10.10
Metric:        10          IS 0000.0000.0001.01
Metric:        10          IP 10.10.10.0 255.255.255.0
Metric:        20          IP 2.2.2.2 255.255.255.255
Metric:        10          IP 1.1.1.1 255.255.255.255
0000.0000.0001.01-00* 0x00000001  0x21B9        895          0/0/0
Metric:        0          IS 0000.0000.0001.00
Metric:        0          IS 0000.0000.0002.00
0000.0000.0002.00-00 0x00000005  0x7B4E        1107          0/0/0
Area Address:  10
NLPID:          IPV4
IP Address:     10.10.10.11
Metric:        10          IS 0000.0000.0001.01
Metric:        10          IP 10.10.10.0 255.255.255.0
Metric:        10          IP 2.2.2.2 255.255.255.255
Metric:        20          IP 1.1.1.1 255.255.255.255

Switch# show ip isis route

Codes: C - connected, E - external, L1 - IS-IS level-1, L2 - IS-IS level-2
       ia - IS-IS inter area, D - discard, e - external metric

Area (null):
  Destination      Metric      Next-Hop      Interface      Tag
C   1.1.1.1/32     10          --            loopback0      0
L1  2.2.2.2/32     20          10.10.10.11  eth-0-9        0
C   10.10.10.0/24  10          --            eth-0-9        0

```

Display the result on Switch2:

```

Switch# show clns neighbors

Area (null):
System Id      Interface  SNPA          State  Holdtime  Type Protocol
0000.0000.0001 eth-0-9    a821.1873.ae00 Up      9         L1   IS-IS

```



```

Up          9          L2    IS-IS

Switch# show isis database verbose
Area (null):
IS-IS Level-1 Link State Database:
LSPID          LSP Seq Num  LSP Checksum  LSP Holdtime  ATT/P/OL
0000.0000.0001.00-00  0x00000004  0x3244        934            0/0/0
  Area Address: 10
  NLPID:        IPV4
  IP Address:   10.10.10.10
  Metric:      10      IS 0000.0000.0001.01
  Metric:      10      IP 10.10.10.0 255.255.255.0
  Metric:      10      IP 1.1.1.1 255.255.255.255
0000.0000.0001.01-00  0x00000001  0x21B9        745            0/0/0
  Metric:      0      IS 0000.0000.0001.00
  Metric:      0      IS 0000.0000.0002.00
0000.0000.0002.00-00* 0x00000004  0xFA75        930            0/0/0
  Area Address: 10
  NLPID:        IPV4
  IP Address:   10.10.10.11
  Metric:      10      IS 0000.0000.0001.01
  Metric:      10      IP 10.10.10.0 255.255.255.0
  Metric:      10      IP 2.2.2.2 255.255.255.255

IS-IS Level-2 Link State Database:
LSPID          LSP Seq Num  LSP Checksum  LSP Holdtime  ATT/P/OL
0000.0000.0001.00-00  0x00000005  0xFCCE        961            0/0/0
  Area Address: 10
  NLPID:        IPV4
  IP Address:   10.10.10.10
  Metric:      10      IS 0000.0000.0001.01
  Metric:      10      IP 10.10.10.0 255.255.255.0
  Metric:      20      IP 2.2.2.2 255.255.255.255
  Metric:      10      IP 1.1.1.1 255.255.255.255
0000.0000.0001.01-00  0x00000001  0x21B9        747            0/0/0
  Metric:      0      IS 0000.0000.0001.00
  Metric:      0      IS 0000.0000.0002.00
0000.0000.0002.00-00* 0x00000005  0x7B4E        960            0/0/0
  Area Address: 10
  NLPID:        IPV4
  IP Address:   10.10.10.11
  Metric:      10      IS 0000.0000.0001.01
  Metric:      10      IP 10.10.10.0 255.255.255.0
  Metric:      10      IP 2.2.2.2 255.255.255.255
  Metric:      20      IP 1.1.1.1 255.255.255.255

Switch# show ip isis route

Codes: C - connected, E - external, L1 - IS-IS level-1, L2 - IS-IS level-2
       ia - IS-IS inter area, D - discard, e - external metric

Area (null):
  Destination      Metric      Next-Hop      Interface      Tag
L1  1.1.1.1/32     20          10.10.10.10  eth-0-9        0
C   2.2.2.2/32     10          --            loopback0      0

```

```
C 10.10.10.0/24 10 -- eth-0-9 0
```

5.8.3 Application cases

N/A

6 Multicast Configuration Guide

6.1 Configuring IP Multicast-Routing

6.1.1 Overview

Function Introduction

Multicast protocols allow a group or channel to be accessed over different networks by multiple stations (clients) for the receipt and transmit of multicast data.

Distribution of stock quotes, video transmissions such as news services and remote classrooms, and video conferencing are all examples of applications that use multicast routing.

- Internet Group Management Protocol (IGMP) is used among hosts on a LAN and the routers (and multilayer switches) on that LAN to track the multicast groups of which hosts are members.
- Protocol-Independent Multicast (PIM) protocol is used among routers and multilayer switches to track which multicast packets to forward to each other and to their directly connected LANs. PIM has two modes: Sparse-mode and Dense-mode.

Principle Description

N/A

6.1.2 Configuration

Configuring multicast route limit

step 1 Enter the configure mode

```
Switch# configure terminal
```

step 2 set the limit of the multicast route

```
Switch(config)# ip multicast route-limit 1000
```

step 3 Exit the configure mode

```
Switch(config)# end
```

step 4 Validation

```
Switch# show ip mroute route-limit
Max Multicast Route Limit Number: 1000
Multicast Route Limit Warning Threshold: 1000
Multicast Hardware Route Limit: 1023
Current Multicast Route Entry Number: 0
```

6.1.3 Application cases

N/A

6.2 Configuring IGMP

6.2.1 Overview

Function Introduction

To participate in IP multicasting, multicast hosts, routers, and multilayer switches must have the IGMP operating. This protocol defines the querier and host roles:

- A querier is a network device that sends query messages to discover which network devices are members of a given multicast group.
- A host is a receiver that sends report messages (in response to query messages) to inform a querier of a host membership.
- A set of queries and hosts that receive multicast data streams from the same source is called a multicast group. Queriers and hosts use IGMP messages to join and leave multicast groups. -- Any host, regardless of whether it is a member of a group, can send to a group. However, only the members of a group receive the message. Membership in a multicast group is dynamic; hosts can join and leave at any time. There is no restriction on the location or number of members in a multicast group.

A host can be a member of more than one multicast group at a time. How active a multicast group is and what members it has can vary from group to group and from time to time. A multicast group can be active for a long time, or it can be very short-lived. Membership in a group can constantly change. A group that has members can have no activity.

IGMP packets are sent using these IP multicast group addresses:

- IGMP general queries are destined to the address 224.0.0.1 (all systems on a subnet).
- IGMP group-specific queries are destined to the group IP address for which the switch is querying.
- IGMP group membership reports are destined to the group IP address for which the switch is reporting.
- IGMP Version 2 (IGMPv2) leave messages are destined to the address 224.0.0.2 (all-multicast-routers on a subnet). In some old host IP stacks, leave messages might be destined to the group IP address rather than to the all-routers address.

Principle Description

Reference to RFC 1112, RFC 2236, RFC 3376

6.2.2 Configuration

There is no explicit command to enable IGMP, which is always combined with PIM-SM. When PIM-SM is enabled on an interface, IGMP will be enabled automatically on this interface, vice versa. But notice, before IGMP can work, IP Multicast-routing must be enabled globally firstly. We support build IGMP group record by learning IGMP packets or configuring static IGMP group by administrator.

step 1 Enter the configure mode

```
Switch# configure terminal
```

step 2 Enable ip multicast-routing globally

```
Switch(config)# ip multicast-routing
```

step 3 Enter the interface configure mode , set the attributes and ip address

```
Switch(config)# interface eth-0-1
Switch(config-if)# no switchport
Switch(config-if)# ip address 10.10.10.10/24
Switch(config-if)# exit

Switch(config)# interface eth-0-2
Switch(config-if)# no switchport
Switch(config-if)# ip address 10.10.11.10/24
Switch(config-if)# exit
```

step 4 Enable pim-sm on the interface

```
Switch(config)# interface eth-0-1
Switch(config-if)# ip pim sparse-mode
Switch(config-if)# exit

Switch(config)# interface eth-0-2
Switch(config-if)# ip pim sparse-mode
Switch(config-if)# exit
```

step 5 Set the attributes for igmp

```
Switch(config)# interface eth-0-1
Switch(config-if)# ip igmp version 2
Switch(config-if)# ip igmp query-interval 120
Switch(config-if)# ip igmp query-max-response-time 12
Switch(config-if)# ip igmp robustness-variable 3
Switch(config-if)# ip igmp last-member-query-count 3
Switch(config-if)# ip igmp last-member-query-interval 2000
Switch(config-if)# exit
```

step 6 Set the maximum igmp group count(optional)

The maximum igmp group count is limited globally or per-interface.

```
Switch(config)# ip igmp limit 2000

Switch(config)# interface eth-0-1
Switch(config-if)# ip igmp limit 1000
```

step 7 Set a static igmp group

```
Switch(config-if)# ip igmp static-group 228.1.1.1
Switch(config-if)# exit
```

step 8 Set igmp proxy(optional)

```
Switch(config)# interface eth-0-1
Switch(config-if)# ip igmp proxy-service
Switch(config-if)# exit

Switch(config)# interface eth-0-2
Switch(config-if)# ip igmp mroute-proxy eth-0-1
Switch(config-if)# exit
```

step 9 Exit the configure mode

```
Switch(config)# end
```

step 10 Validation

Use the following command to display the information of igmp interfaces:

```
Switch# show ip igmp interface
Interface eth-0-1 (Index 1)
  IGMP Inactive, Version 2 (default) proxy-service
  IGMP host version 2
  IGMP global limit is 2000
  IGMP global limit states count is currently 0
  IGMP interface limit is 1000
  IGMP interface has 0 group-record states
  IGMP activity: 0 joins, 0 leaves
  IGMP query interval is 120 seconds
  IGMP querier timeout is 366 seconds
  IGMP max query response time is 12 seconds
  Last member query response interval is 2000 milliseconds
  Group Membership interval is 372 seconds
  Last memeber query count is 3
  Robustness Variable is 3
Interface eth-0-2 (Index 2)
  IGMP Inactive, Version 2 (default)
  IGMP mroute-proxy interface is eth-0-1
  IGMP global limit is 2000
  IGMP global limit states count is currently 0
  IGMP interface limit is 16384
  IGMP interface has 0 group-record states
  IGMP activity: 0 joins, 0 leaves
  IGMP query interval is 125 seconds
  IGMP querier timeout is 255 seconds
  IGMP max query response time is 10 seconds
  Last member query response interval is 1000 milliseconds
  Group Membership interval is 260 seconds
  Last memeber query count is 2
  Robustness Variable is 2
```

Use the following command to display the information of groups:

```
Switch# show ip igmp groups
IGMP Connected Group Membership
Group Address      Interface      Uptime    Expires Last Reporter
228.1.1.1          eth-0-1       00:00:05 stopped -
```

6.2.3 Application cases

N/A

6.3 Configuring PIM-SM

6.3.1 Overview

Function Introduction

The Protocol Independent Multicasting-Sparse Mode (PIM-SM) is a multicast routing protocol designed to operate efficiently across Wide Area Networks (WANs) with sparsely distributed groups. It helps network nodes that are geographically dispersed to conserve bandwidth, and reduces traffic by simultaneously delivering a single stream of information to multiple locations.

PIM-SM uses the IP multicast model of receiver-initiated membership, supporting both shared and shortest-path trees, and uses soft-state mechanisms to adapt to changing network conditions. It relies on a topology-gathering protocol to populate a multicast routing table with routes.

Principle Description

The PIM-SM module is based on the following IETF standard: RFC 4601

Terminology:

- **Rendezvous Point (RP):** A Rendezvous Point (RP) router is configured as the root of the non-source-specific distribution tree for a multicast group. Join messages from receivers for a group are sent towards the RP. Data from senders is sent to the RP so that receivers can discover who the senders are, and receive traffic destined for the group.
- **Multicast Routing Information Base (MRIB):** The MRIB is a multicast topology table derived from the unicast routing table. In PIM-SM, the MRIB is used to

decide where to send Join/Prune messages. It also provides routing metrics for destination addresses. These metrics are used when sending and processing Assert messages.

- **Reverse Path Forwarding:** Reverse Path Forwarding (RPF) is a concept of an optimized form of flooding, where the router accepts a packet from SourceA through Interface IF1 only if IF1 is the interface the router would use in order to reach SourceA. It determines whether the interface is correct by consulting its unicast routing tables. The packet that arrives through interface IF1 is forwarded because the routing table lists this interface as the shortest path to the network. The router's unicast routing table determines the shortest path for the multicast packets. Because a router accepts a packet from only one neighbor, it floods the packet only once, meaning that (assuming point-to-point links) each packet is transmitted over each link once in each direction.
- **Tree Information Base (TIB):** The TIB is the collection of state at a PIM router storing the state of all multicast distribution trees at that router. It is created by receiving Join/Prune messages, Assert messages, and IGMP information from local hosts.
- **Upstream:** Towards to root of the tree. The root of the tree might be either the Source or the RP.
- **Downstream:** Away from the root of the tree. The root of tree might be either the Source or the RP.
- **Source-Based Trees:** In the Source-Based Trees concept, the forwarding paths are based on the shortest unicast path to the source. If the unicast routing metric is hop counts, the branches of the multicast Source-Based Trees are minimum hop. If the metric is delay, the branches are minimum delay. For every multicast source, there is a corresponding multicast tree that directly connects the source to all receivers. All traffic to the members of an associated group passes along the tree made for their source. Source-Based Trees have two entries with a list of outgoing interfaces-- the source address and the multicast group.
- **Shared Trees:** Shared trees or RP trees (RPT) rely on a central router called the Rendezvous Point (RP) that receives all traffic from the sources, and forwards that traffic to the receivers. All hosts might not be receivers. There is a single tree for each multicast group, regardless of the number of sources. Only the routers on the tree know about the group, and information is sent

only to interested receivers. With an RP, receivers have a place to join, even if no source exists. The shared tree is unidirectional, and information flows only from the RP to the receivers. If a host other than the RP has to send data on the tree, the data must first be tunneled to the RP, and then multicast to the members. This means that even if a receiver is also a source, it can only use the tree to receive packets from the RP, and not to send packets to the RP (unless the source is located between the RP and the receivers).

- **Bootstrap Router (BSR):** When a new multicast sender starts sending data packets, or a new receiver starts sending the Join message towards the RP for that multicast group, it needs to know the next-hop router towards the RP. The BSR provides group-to-RP mapping information to all the PIM routers in a domain, allowing them to map to the correct RP address.
- **Sending out Hello Messages:** PIM routers periodically send Hello messages to discover neighboring PIM routers. Hello messages are multicast using the address 224.0.0.13 (ALL-PIM-ROUTERS group). Routers do not send any acknowledgement that a Hello message was received. A hold time value determines the length of time for which the information is valid. In PIM-SM, a downstream receiver must join a group before traffic is forwarded on the interface.
- **Electing a Designated Router:** In a multi-access network with multiple routers connected, one of them is selected to act as a designated router (DR) for a given period of time. The DR is responsible for sending Join/Prune messages to the RP for local members.
- **Determining the RP:** PIM-SM uses a Bootstrap Router (BSR) to originate Bootstrap messages, and to disseminate RP information. The messages are multicast to the group on each link. If the BSR is not apparent, the routers flood the domain with advertisements. The router with the highest priority (if priorities are same, the higher IP address applies) is selected to be the RP. Routers receive and store Bootstrap messages originated by the BSR. When a DR gets a membership indication from IGMP for (or a data packet from) a directly connected host, for a group for which it has no entry, the DR maps the group address to one of the candidate RPs that can service that group. The DR then sends a Join/Prune message towards that RP. In a small domain, the RP can also be configured statically.

- **Joining the Shared Tree:** To join a multicast group, a host sends an IGMP message to its upstream router, after which the router can accept multicast traffic for that group. The router sends a Join message to its upstream PIM neighbor in the direction of the RP. When a router receives a Join message from a downstream router, it checks to see if a state exists for the group in its multicast routing table. If a state already exists, the Join message has reached the shared tree, and the interface from which the message was received is entered in the Outgoing Interface list. If no state exists, an entry is created, the interface is entered in the Outgoing Interface list, and the Join message is again sent towards the RP.
- **Registering with the RP:** A DR can begin receiving traffic from a source without having a Source or a Group state for that source. In this case, the DR has no information on how to get multicast traffic to the RP through a tree. When the source DR receives the initial multicast packet, it encapsulates it in a Register message, and unicasts it to the RP for that group. The RP decapsulates each Register message, and forwards the extracted data packet to downstream members on the RPT. Once the path is established from the source to the RP, the DR begins sending traffic to the RP as standard IP multicast packets, as well as encapsulated within Register messages. The RP temporarily receives packets twice. When the RP detects the normal multicast packets, it sends a Register-Stop message to the source DR, meaning it should stop sending register packets.
- **Sending Register-Stop Messages:** When the RP begins receiving traffic from the source, both as Register messages and as unencapsulated IP packets, it sends a Register-Stop message to the DR. This notifies the DR that the traffic is now being received as standard IP multicast packets on the SPT. When the DR receives this message, it stops encapsulating traffic in Register messages.
- **Pruning the Interface:** Routers attached to receivers send Prune messages to the RP to disassociate the source from the RP. When an RP receives a Prune message, it no longer forwards traffic from the source indicated in the Prune message. If all members of a multicast group are pruned, the IGMP state of the DR is deleted, and the interface is removed from the Source and Group lists of the group.
- **Forwarding Multicast Packets:** PIM-SM routers forward multicast traffic onto all interfaces that lead to receivers that have explicitly joined a multicast

group. Messages are sent to a group address in the local subnetwork, and have a Time to Live (TTL) of 1. The router performs an RPF check, and forwards the packet. Traffic that arrives on the correct interface is sent onto all outgoing interfaces that lead to downstream receivers if the downstream router has sent a join to this router, or is a member of this group.

6.3.2 Configuration

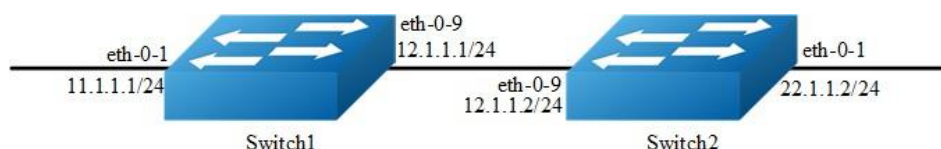

Figure 6-1 Pim sm

PIM-SM is a soft-state protocol. The main requirement is to enable PIM-SM on desired interfaces, and configure the RP information correctly, through static or dynamic methods. All multicast group states are maintained dynamically as the result of IGMP Report/Leave and PIM Join/Prune messages.

This section provides PIM-SM configuration examples for two relevant scenarios. The following graphic displays the network topology used in these examples:

Configuring General PIM Sparse-mode (static RP)

In this example, using the above topology, Switch1 is the Rendezvous Point (RP), and all routers are statically configured with RP information. While configuring the RP, make sure that:

Every router includes the `ip pim rp-address 11.1.1.1` statement, even if it does not have any source or group member attached to it.

There is only one RP address for a group scope in the PIM domain.

All interfaces running PIM-SM must have sparse-mode enabled.

Here is a sample configuration:

step 1 Enter the configure mode

```
Switch# configure terminal
```

step 2 Enter the interface configure mode , set the attributes and ip address, and enable pim-sm

Configuring on Switch1:

```
Switch(config)# interface eth-0-1
Switch(config-if)# no shutdown
Switch(config-if)# no switchport
Switch(config-if)# ip address 11.1.1.1/24
Switch(config-if)# ip pim sparse-mode
Switch(config-if)# exit

Switch(config)# interface eth-0-9
Switch(config-if)# no shutdown
Switch(config-if)# no switchport
Switch(config-if)# ip address 12.1.1.1/24
Switch(config-if)# ip pim sparse-mode
Switch(config-if)# exit
```

Configuring on Switch2:

```
Switch(config)# interface eth-0-1
Switch(config-if)# no shutdown
Switch(config-if)# no switchport
Switch(config-if)# ip address 22.1.1.2/24
Switch(config-if)# ip pim sparse-mode
Switch(config-if)# exit

Switch(config)# interface eth-0-9
Switch(config-if)# no shutdown
Switch(config-if)# no switchport
Switch(config-if)# ip address 12.1.1.2/24
Switch(config-if)# ip pim sparse-mode
Switch(config-if)# exit
```

step 3 Add static routes

Configuring on Switch1:

```
Switch(config)# ip route 22.1.1.0/24 12.1.1.2
```

Configuring on Switch2:

```
Switch(config)# ip route 11.1.1.0/24 12.1.1.1
```

step 4 Configure the static rp address

```
Switch(config)# ip pim rp-address 11.1.1.1
```

step 5 Exit the configure mode

```
Switch(config)# end
```

step 6 Validation

Use the following command to show ip pim sparse-mode rp mapping. 11.1.1.1 is the RP for all multicast groups 224.0.0.0/4 which is statically configured.

```
Switch# show ip pim sparse-mode rp mapping
PIM group-to-RP mappings
Group(s): 224.0.0.0/4, Static
  RP: 11.1.1.1
  Uptime: 00:08:21
```

Use the following command to show the interface information:

```
Switch# show ip pim sparse-mode interface
```

Address	Interface	VIFindex	Ver/ Mode	Nbr Count	DR Prior	DR	HoldTime
11.1.1.1	eth-0-1	2	v2/S	0	1	11.1.1.1	105
12.1.1.1	eth-0-9	0	v2/S	1	1	12.1.1.2	105

Use the following command to show the pim sparse-mode multicast routes: Switch1

:

```
Switch# show ip pim sparse-mode mroute detail
IP Multicast Routing Table
(*,*,RP) Entries: 0
(*,G) Entries: 1
(S,G) Entries: 0
(S,G,rpt) Entries: 0
FCR Entries: 0
(*, 224.1.1.1) Uptime: 00:01:32
  RP: 11.1.1.1, RPF nbr: None, RPF idx: None
  Upstream:
    State: JOINED, SPT Switch: Enabled, JT: off
    Macro state: Join Desired,
  Downstream:
    eth-0-9:
      State: JOINED, ET Expiry: 179 secs, PPT: off
      Assert State: NO INFO, AT: off
      Winner: 0.0.0.0, Metric: 4294967295, Pref: 4294967295, RPT bit: on
      Macro state: Could Assert, Assert Track
  Join Olist:
    eth-0-9
```

Switch2:

```
Switch# show ip pim sparse-mode mroute detail
IP Multicast Routing Table
(*,*,RP) Entries: 0
```

```

(*,G) Entries: 1
(S,G) Entries: 0
(S,G,rpt) Entries: 0
FCR Entries: 0
(*, 224.1.1.1) Uptime: 00:00:43
  RP: 11.1.1.1, RPF nbr: 12.1.1.1, RPF idx: eth-0-9
  Upstream:
    State: JOINED, SPT Switch: Enabled, JT Expiry: 18 secs
    Macro state: Join Desired,
  Downstream:
    eth-0-1:
      State: NO INFO, ET: off, PPT: off
      Assert State: NO INFO, AT: off
      Winner: 0.0.0.0, Metric: 4294967295, Pref: 4294967295, RPT bit: on
      Macro state: Could Assert, Assert Track
  Local Olist:
    eth-0-1

```

Configuring General PIM Sparse-mode (dynamic RP)

A static configuration of RP works for a small, stable PIM domain; however, it is not practical for a large and not-suitable internet work. In such a network, if the RP fails, the network administrator might have to change the static configurations on all PIM routers. Another reason for choosing dynamic configuration is a higher routing traffic leading to a change in the RP.

We use the BSR mechanism to dynamically maintain the RP information. For configuring RP dynamically in the above scenario, Switch1 on eth-0-1 and Switch2 on eth-0-9 are configured as Candidate RP using the `ip pim rp-candidate` command. Switch2 on eth-0-9 is also configured as Candidate BSR. Since no other router has been configured as Candidate BSR, the Switch2 becomes the BSR router, and is responsible for sending group-to-RP mapping information to all other routers in this PIM domain.

step 1 Enter the configure mode

```
Switch# configure terminal
```

step 2 Enter the interface configure mode , set the attributes and ip address, and enable pim-sm

Configuring on Switch1:

```
Switch(config)# interface eth-0-1
Switch(config-if)# no shutdown
Switch(config-if)# no switchport
```

```
Switch(config-if)# ip address 11.1.1.1/24
Switch(config-if)# ip pim sparse-mode
Switch(config-if)# exit

Switch(config)# interface eth-0-9
Switch(config-if)# no shutdown
Switch(config-if)# no switchport
Switch(config-if)# ip address 12.1.1.1/24
Switch(config-if)# ip pim sparse-mode
Switch(config-if)# exit
```

Configuring on Switch2:

```
Switch(config)# interface eth-0-1
Switch(config-if)# no shutdown
Switch(config-if)# no switchport
Switch(config-if)# ip address 22.1.1.2/24
Switch(config-if)# ip pim sparse-mode
Switch(config-if)# exit

Switch(config)# interface eth-0-9
Switch(config-if)# no shutdown
Switch(config-if)# no switchport
Switch(config-if)# ip address 12.1.1.2/24
Switch(config-if)# ip pim sparse-mode
Switch(config-if)# exit
```

step 3 Add static routes

Configuring on Switch1:

```
Switch(config)# ip route 22.1.1.0/24 12.1.1.2
```

Configuring on Switch2:

```
Switch(config)# ip route 11.1.1.0/24 12.1.1.1
```

step 4 Configure the rp candidate

Configuring on Switch1:

```
Switch(config)# ip pim rp-candidate eth-0-1
```

Configuring on Switch2:

```
Switch(config)# ip pim rp-candidate eth-0-9
Switch(config)# ip pim bsr-candidate eth-0-9
```



NOTE The highest priority router is chosen as the RP. If two or more routers have the same priority, a hash function in the BSR mechanism is used to choose the RP, to make sure that all routers in the PIM-domain have the same RP for

the same group. Use the `ip pim rp-candidate IFNAME PRIORITY` command to change the default priority of any candidate RP.

step 5 Exit the configure mode

```
Switch(config)# end
```

step 6 Validation

Use the `show ip pim sparse-mode rp mapping` command to display the group-to-RP mapping details. The output displays information about RP candidates. There are two RP candidates for the group range 224.0.0.0/4. RP Candidate 11.1.1.1 has a default priority of 192, whereas, RP Candidate 12.1.1.2 has been configured to have a priority of 2. Since RP candidate 12.1.1.2 has a higher priority, it is selected as RP for the multicast group 224.0.0.0/24. Only permit filters would be cared in group list.

Switch2:

```
switch# show ip pim sparse-mode rp mapping
PIM group-to-RP mappings
This system is the bootstrap router (v2)
Group(s): 224.0.0.0/4
  RP: 12.1.1.2
    Info source: 12.1.1.2, via bootstrap, priority 2
    Uptime: 01:55:20, expires: 00:02:17
  RP: 11.1.1.1
    Info source: 11.1.1.1, via bootstrap, priority 192
    Uptime: 01:55:23, expires: 00:02:13
```

To display information about the RP router for a particular group, use the following command. This output displays that 12.1.1.2 has been chosen as the RP for the multicast group 224.1.1.1.

Switch2:

```
switch# show ip pim sparse-mode rp-hash 224.1.1.1
  RP: 12.1.1.2
    Info source: 12.1.1.2, via bootstrap
```

After RP information reaches all PIM routers in the domain, various state machines maintain all routing states as the result of Join/Prune from group membership. To display information on interface details and the multicast routing table, refer to the [Configuring RP Statically](#) section above.

Configuring Bootstrap Router

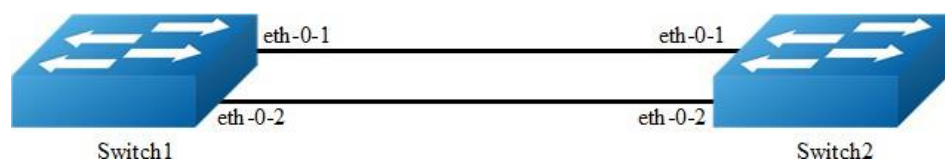

Figure 6-2 bsr

Every PIM multicast group needs to be associated with the IP address of a Rendezvous Point (RP). This address is used as the root of a group-specific distribution tree whose branches extend to all nodes in the domain that want to receive traffic sent to the group. For all senders to reach all receivers, all routers in the domain use the same mappings of group addresses to RP addresses. In order to determine the RP for a multicast group, a PIM router maintains a collection of group-to-RP mappings, called the RP-Set.

The Bootstrap Router (BSR) mechanism for the class of multicast routing protocols in the PIM domain use the concept of a Rendezvous Point as a means for receivers to discover the sources that send to a particular multicast group. The BSR mechanism is one way that a multicast router can learn the set of group-to-RP mappings required in order to function.

Some of the PIM routers within a PIM domain are configured as Candidate-RPs (C-RPs). A subset of the C-RPs will eventually be used as the actual RPs for the domain. An RP configured with a lower value in the priority field has higher a priority.

Some of the PIM routers in the domain are configured to be Candidate-BSRs (C-BSRs). One of these C-BSRs is elected to be the bootstrap router (BSR) for the domain, and all PIM routers in the domain learn the result of this election through BSM (Bootstrap messages). The C-BSR with highest value in priority field is Elected-BSR.

The C-RPs then reports their candidacy to the elected BSR, which chooses a subset of the C-RPs and distributes corresponding group-to-RP mappings to all the routers in the domain through Bootstrap messages.

step 1 Enter the configure mode

```
Switch# configure terminal
```

step 2 Configure the bsr candidate and rp candidate

Switch1:

```
Switch(config)# ip pim bsr-candidate eth-0-1
```

Switch2:

```
Switch(config)# ip pim bsr-candidate eth-0-1 10 25
Switch(config)# ip pim rp-candidate eth-0-1 priority 0
```

step 3 Configure the priority of rp candidate

```
Switch(config)# ip pim rp-candidate eth-0-1 priority 0
```

step 4 Configure the priority of dr and enable receive and send unicast bsm packets

```
Switch(config)# interface eth-0-1
Switch(config-if)# ip pim dr-priority 10
Switch(config-if)# ip pim unicast-bsm
```

step 5 Exit the configure mode

```
Switch(config-if)# end
```

step 6 Validation

Verify the C-BSR state on rtr1

```
Switch# show ip pim sparse-mode bsr-router
PIMv2 Bootstrap information
This system is the Bootstrap Router (BSR)
BSR address: 20.0.1.21
Uptime: 00:37:12, BSR Priority: 64, Hash mask length: 10
Next bootstrap message in 00:00:04
Role: Candidate BSR
State: Elected BSR
```

Verify the C-BSR state on rtr2

```
Switch# show ip pim sparse-mode bsr-router
PIMv2 Bootstrap information
BSR address: 20.0.1.21
Uptime: 00:02:39, BSR Priority: 64, Hash mask length: 10
Expires: 00:00:03
Role: Candidate BSR
State: Pending BSR
Switch# show ip pim sparse-mode bsr-router
PIMv2 Bootstrap information
```

```
BSR address: 20.0.1.21
Uptime: 00:40:20, BSR Priority: 64, Hash mask length: 10
Expires: 00:02:07
Role: Candidate BSR
State: Candidate BSR
```

Verify RP-set information on E-BSR

```
Switch# sh ip pim sparse-mode rp mapping
PIM Group-to-RP Mappings
This system is the Bootstrap Router (v2)
Group(s): 224.0.0.0/4
RP: 20.0.1.11
Info source: 20.0.1.11, via bootstrap, priority 0
Uptime: 00:00:30, expires: 00:02:04
```

Verify RP-set information on C-BSR

```
Switch# show ip pim sparse-mode rp mapping
PIM Group-to-RP Mappings
Group(s): 224.0.0.0/4
RP: 20.0.1.11
Info source: 20.0.1.21, via bootstrap, priority 0
Uptime: 00:00:12, expires: 00:02:18
```

Configuring PIM-SSM feature

The Source Specific Multicast feature is an extension of IP multicast where datagram traffic is forwarded to receivers from only those multicast sources to which the receivers have explicitly joined. For multicast groups configured for SSM, only source-specific multicast distribution trees (no shared trees) are created.

PIM-SSM is the routing protocol that supports the implementation of SSM and is derived from PIM sparse mode (PIM-SM).

PIM-SSM can work with PIM-SM on the multicast router. By default, PIM-SSM is disabled.

step 1 Enter the configure mode

```
Switch# configure terminal
```

step 2 Enable ssm

Enable by default range:

```
Switch(config)# ip pim ssm default
```

Enable pim-ssm on the switch and set the ssm group range as group range specified in an access list:

```
Switch(config)# ip pim ssm range ipacl
```

The 2 commands above are alternative. The final configuration should over write the previous one and take effect.

step 3 Exit the configure mode

```
Switch(config)# end
```

step 4 Validation

```
Switch# show running-config | include pim  
ip pim ssm range ipacl
```

6.3.3 Application cases

N/A

6.4 Configuring PIM-DM

6.4.1 Overview

Function Introduction

The Protocol Independent Multicasting-Dense Mode (PIM-DM) is a multicast routing protocol designed to operate efficiently across Wide Area Networks (WANs) with densely distributed groups. It helps network nodes that are geographically dispersed to conserve bandwidth, and reduces traffic by simultaneously delivering a single stream of information to multiple locations.

PIM-DM assumes that when a source starts sending, all down stream systems want to receive multicast datagrams. Initially, multicast datagrams are flooded to all areas of the network. PIM-DM uses RPF to prevent looping of multicast datagrams while flooding. If some areas of the network do not have group members, PIM-DM will prune off the forwarding branch by instantiating prune state.

Prune state has a finite lifetime. When that lifetime expires, data will again be forwarded down the previously pruned branch. Prune state is associated with an (S,G) pair. When a new member for a group G appears in a pruned area, a router can "graft"

toward the source S for the group, thereby turning the pruned branch back into a forwarding branch.

Principle Description

The PIM-DM module is based on the following IETF standard: RFC 3973

6.4.2 Configuration

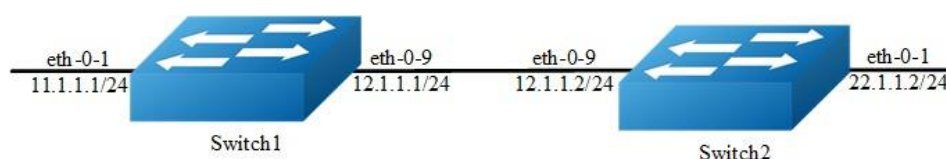

Figure 6-3 Pim dm

PIM-DM is a soft-state protocol. The main requirement is to enable PIM-DM on desired interfaces. All multicast group states are maintained dynamically as the result of IGMP Report/Leave and PIM messages.

This section provides PIM-DM configuration examples for two relevant scenarios. The following graphic displays the network topology used in these examples:

In this example, using the above topology, multicast data stream comes to eth-0-1 of Switch1, host is connected to eth-0-1 of Switch2.

step 1 Enter the configure mode

```
Switch# configure terminal
```

step 2 Enter the interface configure mode , set the attributes and ip address, and enable pim-dm

Configuring on Switch1:

```
Switch(config)# interface eth-0-1
Switch(config-if)# no shutdown
Switch(config-if)# no switchport
Switch(config-if)# ip address 11.1.1.1/24
Switch(config-if)# ip pim dense-mode
Switch(config-if)# exit

Switch(config)# interface eth-0-9
Switch(config-if)# no shutdown
Switch(config-if)# no switchport
```

```
Switch(config-if)# ip address 12.1.1.1/24
Switch(config-if)# ip pim dense-mode
Switch(config-if)# exit
```

Configuring on Switch2:

```
Switch# configure terminal
Switch(config)# interface eth-0-1
Switch(config-if)# no shutdown
Switch(config-if)# no switchport
Switch(config-if)# ip address 22.1.1.2/24
Switch(config-if)# ip pim dense-mode
Switch(config-if)# exit

Switch(config)# interface eth-0-9
Switch(config-if)# no shutdown
Switch(config-if)# no switchport
Switch(config-if)# ip address 12.1.1.2/24
Switch(config-if)# ip pim dense-mode
Switch(config-if)# exit
```

step 3 Add static routes

Configuring on Switch1:

```
Switch(config)# ip route 22.1.1.0/24 12.1.1.2
```

Configuring on Switch2:

```
Switch(config)# ip route 11.1.1.0/24 12.1.1.1
```

step 4 Exit the configure mode

```
Switch(config)# end
```

step 5 Validation

The "show ip pim dense-mode interface" command displays the interface details for Switch1.

```
Switch# show ip pim dense-mode interface
Address          Interface VIFIndex Ver/  Nbr
                Mode     Count
11.1.1.1         eth-0-1  0       v2/D  0
12.1.1.1         eth-0-9  1       v2/D  1
```

The "show ip pim dense-mode neighbor" command displays the neighbor details for Switch1.

```
Switch# show ip pim dense -mode neighbor
Neighbor-Address Interface          Uptime/Expires    Ver
12.1.1.2          eth-0-9            00:01:00/00:01:44 v2
```

The "show ip pim dense-mode mroute detail" command displays the IP multicast routing table.

Switch1:

```
Switch# show ip pim dense-mode mroute
PIM-DM Multicast Routing Table
(11.1.1.2, 225.1.1.1)
Source directly connected on eth-0-1
State-Refresh Originator State: Originator
Upstream IF: eth-0-1
  Upstream State: Forwarding
  Assert State: NoInfo
Downstream IF List:
  eth-0-9, in 'olist':
    Downstream State: NoInfo
    Assert State: NoInfo
```

Switch2:

```
Switch# show ip pim dense-mode mroute
PIM-DM Multicast Routing Table
(11.1.1.2, 225.1.1.1)
RPF Neighbor: none
Upstream IF: eth-0-9
  Upstream State: AckPending
  Assert State: NoInfo
Downstream IF List:
  eth-0-1, in 'olist':
    Downstream State: NoInfo
    Assert State: NoInfo
```

6.4.3 Application cases

N/A

6.5 Configuring IGMP Snooping

6.5.1 Overview

Function Introduction

Layer 2 switches can use IGMP snooping to constrain the flooding of multicast traffic by dynamically configuring Layer 2 interfaces so that multicast traffic is forwarded only to those interfaces associated with IP multicast devices. As the name implies, IGMP snooping requires the LAN switch to snoop on the IGMP transmissions between

the host and the router and to keep track of multicast groups and member ports. When the switch receives an IGMP report from a host for a particular multicast group, the switch adds the host port number to the forwarding table entry; when it receives an IGMP Leave Group message from a host, it removes the host port from the table entry. It also deletes entries per entry if it does not receive IGMP membership reports from the multicast clients. The multicast router sends out periodic general queries to all VLANs. All hosts interested in this multicast traffic send report and are added to the forwarding table entry. The switch forwards only one report per IP multicast group to the multicast router. It creates one entry per VLAN in the Layer 2 forwarding table for each MAC group from which it receives an IGMP report.

Layer 2 multicast groups learned through IGMP snooping are dynamic. If you specify group membership for a multicast group address statically, your setting supersedes any automatic manipulation by IGMP snooping. Multicast group membership lists can consist of both user-defined and IGMP snooping-learned settings

Limitations And Notice:

VRRP, RIP and OSPF used multicast IP address, so you need to avoid use such multicast IP addresses, which have same multicast MAC address with multicast IP address reserved by VRRP, RIP and OSPF.

VRRP used multicast group address 224.0.0.18, so when igmp snooping and VRRP are working, you need to avoid using multicast group address that matched same mac address with group address 224.0.0.18.

OSPF used multicast group address 224.0.0.5, so when igmp snooping and OSFP are working, you need to avoid using multicast group address that matched same mac address with group address 224.0.0.18.

RIP used multicast group address 224.0.0.9, so when igmp snooping and RIP are working, you need to avoid using multicast group address that matched same mac address with group address 224.0.0.9.

Principle Description

N/A

6.5.2 Configuration

Enable Globally Or Per Vlan

IGMP Snooping can be enabled globally or per vlan. If IGMP Snooping is disabled globally, it can't be active on any vlan even it is enabled on the vlan. If IGMP snooping is enabled globally, it can be disabled on a vlan. On the other hand, the global configuration can overwrite the per vlan configuration. By default, IGMP snooping is enabled globally and per vlan.

step 1 Enter the configure mode

```
Switch#configure terminal
```

step 2 Enable igmp snooping globally and per-vlan

```
Switch(config)# ip igmp snooping
Switch(config)# ip igmp snooping vlan 1
```

step 3 Exit the configure mode

```
Switch(config)# end
```

step 4 Validation

Use the following command to display igmp snooping of a vlan:

```
Switch # show ip igmp snooping vlan 1
Global Igmp Snooping Configuration
-----
Igmp Snooping                :Enabled
Igmp Snooping Fast-Leave      :Disabled
Igmp Snooping Version        2
Igmp Snooping Robustness Variable 2
Igmp Snooping Max-Member-Number 2048
Igmp Snooping Unknown Multicast Behavior :Flood
Igmp Snooping Report-Suppression :Enabled
Vlan 1
-----
Igmp Snooping                :Enabled
Igmp Snooping Fast-Leave      :Disabled
Igmp Snooping Report-Suppression :Enabled
Igmp Snooping Version        2
Igmp Snooping Robustness Variable 2
Igmp Snooping Max-Member-Number 2048
Igmp Snooping Unknown Multicast Behavior :Flood
```

```

Igmp Snooping Group Access-list      :N/A
Igmp Snooping Mrouter Port           :
Igmp Snooping Mrouter Port Aging Interval(sec) :255

```

Configuring Fast Leave

When IGMP Snooping fast leave is enabled, the igmp snooping group will be removed at once upon receiving a corresponding igmp report. Otherwise the switch will send out specified igmp specific query, if it doesn't get response in specified period, it will remove the group. By default, igmp snooping fast-leave is disabled globally and per vlan.

step 1 Enter the configure mode

```
Switch#configure terminal
```

step 2 Enable Fast Leave globally and per-vlan

```
Switch(config)#ip igmp snooping fast-leave
Switch(config)#ip igmp snooping vlan 1 fast-leave
```

step 3 Exit the configure mode

```
Switch(config)# end
```

step 4 Validation

```

Switch # show ip igmp snooping vlan 1
Global Igmp Snooping Configuration
-----
Igmp Snooping                :Enabled
Igmp Snooping Fast-Leave      :Enabled
Igmp Snooping Version        2
Igmp Snooping Robustness Variable 2
Igmp Snooping Max-Member-Number 2048
Igmp Snooping Unknown Multicast Behavior :Flood
Igmp Snooping Report-Suppression :Enabled
Vlan 1

Igmp Snooping                :Enabled
Igmp Snooping Fast-Leave      :Enabled
Igmp Snooping Report-Suppression :Enabled
Igmp Snooping Version        2
Igmp Snooping Robustness Variable 2
Igmp Snooping Max-Member-Number 2048
Igmp Snooping Unknown Multicast Behavior :Flood
Igmp Snooping Group Access-list :N/A

```

```
Igmp Snooping Mrouter Port :
Igmp Snooping Mrouter Port Aging Interval(sec) :255
```

Configuring Querier Parameters

In order for IGMP, and thus IGMP snooping, to function, a multicast router must exist on the network and generate IGMP queries. The tables created for snooping (holding the member ports for a each multicast group) are associated with the querier. Without a querier the tables are not created and snooping will not work.

step 1 Enter the configure mode

```
Switch#configure terminal
```

step 2 Set the global attributes of igmp snooping

```
Switch(config)# ip igmp snooping query-interval 100
Switch(config)# ip igmp snooping query-max-response-time 5
Switch(config)# ip igmp snooping last-member-query-interval 2000
Switch(config)# ip igmp snooping discard-unknown
```

step 3 Set the per-vlan attributes of igmp snooping

```
Switch(config)# ip igmp snooping vlan 1 querier address 10.10.10.1
Switch(config)# ip igmp snooping vlan 1 querier
Switch(config)# ip igmp snooping vlan 1 query-interval 200
Switch(config)# ip igmp snooping vlan 1 query-max-response-time 5
Switch(config)# ip igmp snooping vlan 1 querier-timeout 100
Switch(config)# ip igmp snooping vlan 1 last-member-query-interval 2000
Switch(config)# ip igmp snooping vlan 1 discard-unknown
```

step 4 Exit the configure mode

```
Switch(config)# end
```

step 5 Validation

```
Switch # show ip igmp snooping querier
Global Igmp Snooping Querier Configuration
-----
Version                               2
Last-Member-Query-Interval (msec) :2000
Last-Member-Query-Count                2
Max-Query-Response-Time (sec)         5
Query-Interval (sec)                   100
Global Source-Address                  :0.0.0.0
TCN Query Count                         2
TCN Query Interval (sec)                10
```

```

TCN Query Max Respose Time (sec) :5
Vlan 1: IGMP snooping querier status
-----
Elected querier is : 0.0.0.0
-----
Admin state :Enabled
Admin version 2
Operational state :Non-Querier
Querier operational address :10.10.10.1
Querier configure address :10.10.10.1
Last-Member-Query-Interval (msec) 2000
Last-Member-Query-Count 2
Max-Query-Response-Time (sec) 5
Query-Interval (sec) 200
Querier-Timeout (sec) 100

```

Configuring Mrouter Port

An IGMP Snooping mrouter port is a switch port which is assumed to connect a multicast router. The mrouter port is configured on the vlan or learnt dynamic. When IGMP general query packet or PIMv2 hello packet is received on port of specified VLAN, this port becomes mrouter port of this vlan. All the igmp queries received on this port will be flooded on the belonged vlan. All the igmp reports and leaves received on this vlan will be forwarded to the mrouter port, directly or aggregated, depending on the report-suppression configuration. In addition, all the multicast traffic on this vlan will be forwarded to this mrouter port.

step 1 Enter the configure mode

```
Switch#configure terminal
```

step 2 Enable igmp snooping report suppression globally

```
Switch(config)# ip igmp snooping report-suppression
```

step 3 Configure mrouter port, Enable igmp snooping report suppression, and set igmp snooping dynamic mrouter port aging interval for a vlan

```
Switch(config)# ip igmp snooping vlan 1 mrouter interface eth-0-1
Switch(config)# ip igmp snooping vlan 1 report-suppression
Switch(config)# ip igmp snooping vlan 1 mrouter-aging-interval 200
```

step 4 Exit the configure mode

```
Switch(config)# end
```

step 5 Validation

```
Switch# show ip igmp snooping vlan 1
Global Igmp Snooping Configuration
-----
Igmp Snooping                               :Enabled
Igmp Snooping Fast-Leave                     :Disabled
Igmp Snooping Version                       2
Igmp Snooping Robustness Variable           2
Igmp Snooping Max-Member-Number            2048
Igmp Snooping Unknown Multicast Behavior   :Flood
Igmp Snooping Report-Suppression           :Enabled
Vlan 1

Igmp Snooping                               :Enabled
Igmp Snooping Fast-Leave                     :Disabled
Igmp Snooping Report-Suppression           :Enabled
Igmp Snooping Version                       2
Igmp Snooping Robustness Variable           2
Igmp Snooping Max-Member-Number            2048
Igmp Snooping Unknown Multicast Behavior   :Flood
Igmp Snooping Group Access-list            :N/A
Igmp Snooping Mrouter Port                  :eth-0-1
Igmp Snooping Mrouter Port Aging Interval(sec) 200
```

Configuring Querier TCN

System supports to adapt the multicast router learning and updating after STP convergence by configuring the TCN querier count and querier interval.

step 1 Enter the configure mode

```
Switch#configure terminal
```

step 2 Configuring the TCN querier count and querier interval

```
Switch(config)# ip igmp snooping querier tcn query-count 5
Switch(config)# ip igmp snooping querier tcn query-interval 20
```

step 3 Exit the configure mode

```
Switch(config)# end
```

step 4 Validation

```
Switch # show ip igmp snooping querier
Global Igmp Snooping Querier Configuration
-----
Version                               :2
```

```

Last-Member-Query-Interval (msec) :1000
Max-Query-Response-Time (sec)      10
Query-Interval (sec)               125
Global Source-Address               :0.0.0.0
TCN Query Count                    5
TCN Query Interval (sec)           20
Vlan 1:  IGMP snooping querier status
-----
Elected querier is : 0.0.0.0
-----
Admin state                         :Disabled
Admin version                       2
Operational state                   :Non-Querier
Querier operational address          :0.0.0.0
Querier configure address            :N/A
Last-Member-Query-Interval (msec)  1000
Max-Query-Response-Time (sec)      10
Query-Interval (sec)               125
Querier-Timeout (sec)              255

```

Configuring Report Suppression

The switch uses IGMP report suppression to forward only one IGMP report per multicast router query to multicast devices. When IGMP router suppression is enabled (the default), the switch sends the first IGMP report from all hosts for a group to all the multicast routers. The switch does not send the remaining IGMP reports for the group to the multicast routers. This feature prevents duplicate reports from being sent to the multicast devices.

step 1 Enter the configure mode

```
Switch#configure terminal
```

step 2 Enable Report Suppression globally and per-vlan

```
Switch(config)# ip igmp snooping report-suppression
Switch(config)# ip igmp snooping vlan 1 report-suppression
```

step 3 Exit the configure mode

```
Switch(config)# end
```

step 4 Validation

```
Switch # show ip igmp snooping
Global Igmp Snooping Configuration
-----
Igmp Snooping                               :Enabled
```

```

Igmp Snooping Fast-Leave           :Disabled
Igmp Snooping Version             :2
Igmp Snooping Robustness Variable :2
Igmp Snooping Max-Member-Number   :2048
Igmp Snooping Unknown Multicast Behavior :Flood
Igmp Snooping Report-Suppression  :Enabled
Vlan 1
-----
Igmp Snooping                     :Enabled
Igmp Snooping Fast-Leave           :Disabled
Igmp Snooping Report-Suppression  :Enabled
Igmp Snooping Version             :2
Igmp Snooping Robustness Variable :2
Igmp Snooping Max-Member-Number   :2048
Igmp Snooping Unknown Multicast Behavior :Flood
Igmp Snooping Group Access-list   :N/A
Igmp Snooping Mrouter Port        :
Igmp Snooping Mrouter Port Aging Interval(sec) :255

```

Configuring Static group

The switch can build IGMP Snooping Group when receiving IGMP report packet on Layer 2 port of specified VLAN. We also support configure static IGMP Snooping Group by specifying IGMP group, Layer 2 port and VLAN.

step 1 Enter the configure mode

```
Switch#configure terminal
```

step 2 Configure static group

```
Switch(config)# ip igmp snooping vlan 1 static-group 229.1.1.1 interface eth-0-2
```

step 3 Exit the configure mode

```
Switch(config)# end
```

step 4 Validation

```
Switch# show ip igmp snooping groups
VLAN  Interface      Group-Address  Uptime    Expires-time
1      eth-0-2           229.1.1.1     00:01:08  stopped
```

6.5.3 Application cases

N/A

6.6 Configuring MVR

6.6.1 Overview

Function Introduction

Multicast VLAN Registration (MVR) is designed for applications using wide-scale deployment of multicast traffic across an Ethernet ring-based service provider network (for example, the broadcast of multiple television channels over a service-provider network). MVR allows a subscriber on a port to subscribe and unsubscribe to a multicast stream on the network-wide multicast VLAN. It allows the single multicast VLAN to be shared in the network while subscribers remain in separate VLANs. MVR provides the ability to continuously send multicast streams in the multicast VLAN, but to isolate the streams from the subscriber VLANs for bandwidth and security reasons.

MVR assumes that subscriber ports subscribe and unsubscribe (join and leave) these multicast streams by sending out IGMP join and leave messages. These messages can originate from an IGMP version-2-compatible host with an Ethernet connection. Although MVR operates on the underlying mechanism of IGMP snooping, the two features operation affect with each other. One can be enabled or disabled with affecting the behavior of the other feature. If IGMP snooping and MVR are both enabled, MVR reacts only to join and leave messages from multicast groups configured under MVR. The switch CPU identifies the MVR IP multicast streams and their associated MAC addresses in the switch forwarding table, intercepts the IGMP messages, and modifies the forwarding table to include or remove the subscriber as a receiver of the multicast stream, and the receivers must be in a different VLAN from the source. This forwarding behavior selectively allows traffic to cross between different VLANs.

Principle Description

Terminology:

terminology	Description
MVR	Multicast Vlan Registration.

Source vlan	The vlan for receiving multicast traffic for MVR.
Source port	The port in the source vlan for sending report or leave to upstream.
Receiver port	The port not in source vlan for receiving report or leave for downstream.

6.6.2 Configuration

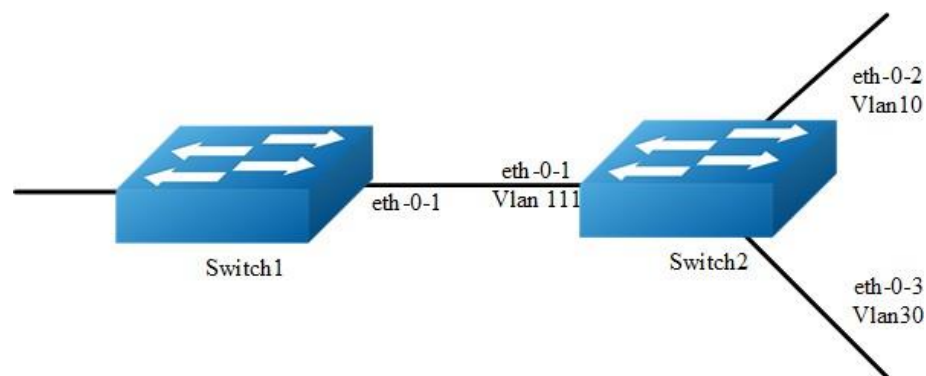

Figure 6-4 mvr

Enable IGMP&PIM-SM in the interface of eth-0-1 of Switch1.

Configure Switch2: eth-0-1 in vlan111, eth-0-2 in vlan10, and eth-0-3 vlan30.

Enable MVR in the Switch2, it is required that only one copy of multicast traffic from Switch1 is sent to Switch2, but HostA and HostC can both receive this multicast traffic.

step 1 Enter the configure mode

```
Switch# configure terminal
```

step 2 Enter the vlan configure mode and create vlan

Configure on switch1:

```
Switch(config)# vlan database
Switch(config-vlan)# vlan 111,10,30
Switch(config-vlan)# quit
```

step 3 Enter the interface configure mode , set the attributes and ip address, and enable pim-sm

Configure on switch1:

```
switch(config)# interface eth-0-1
switch(config-if)# no switchport
switch(config-if)# no shutdown
switch(config-if)# ip address 12.12.12.12/24
switch(config-if)# ip pim sparse-mode
switch(config-if)# exit
```

Configure on switch2:

```
Switch(config)# interface vlan 111
Switch(config-if)# exit
Switch(config)# interface vlan 10
Switch(config-if)# exit
Switch(config)# interface vlan 30
Switch(config-if)# exit
Switch(config)# interface eth-0-1
Switch(config-if)# switchport access vlan111
Switch(config)# interface eth-0-2
Switch(config-if)# switchport access vlan10
Switch(config)# interface eth-0-3
Switch(config-if)# switchport access vlan30
Switch(config-if)# exit
```

step 4 Enable MVR

Configure on switch2:

```
Switch(config)# no ip multicast-routing
Switch(config)# mvr
Switch(config)# mvr vlan 111
Switch(config)# mvr group 238.255.0.1 64
Switch(config)# mvr source-address 12.12.12.1
Switch(config)# interface eth-0-1
Switch(config-if)# mvr type source
Switch(config)# interface eth-0-2
Switch(config-if)# mvr type receiver vlan 10
Switch(config)# interface eth-0-3
Switch(config-if)# mvr type receiver vlan 30
Switch(config-if)# exit
```

step 5 Exit the configure mode

```
Switch(config)# end
```

step 6 Validation

Switch1

```
Switch# show ip igmp groups
IGMP Connected Group Membership
Group Address      Interface          Uptime    Expires    Last Reporter
238.255.0.1        eth-0-1           00:01:16 00:03:49 12.12.12.1
238.255.0.2        eth-0-1           00:01:16 00:03:49 12.12.12.1
238.255.0.3        eth-0-1           00:01:16 00:03:49 12.12.12.1
238.255.0.4        eth-0-1           00:01:16 00:03:49 12.12.12.1
238.255.0.5        eth-0-1           00:01:16 00:03:49 12.12.12.1
238.255.0.6        eth-0-1           00:01:16 00:03:49 12.12.12.1
238.255.0.7        eth-0-1           00:01:16 00:03:49 12.12.12.1
238.255.0.8        eth-0-1           00:01:16 00:03:49 12.12.12.1
238.255.0.9        eth-0-1           00:01:16 00:03:49 12.12.12.1
238.255.0.10       eth-0-1           00:01:16 00:03:49 12.12.12.1
.....
238.255.0.64       eth-0-1           00:01:16 00:03:49 12.12.12.1
```

Switch2

```
Switch# show mvr
MVR Running: TRUE
MVR Multicast VLAN: 111
MVR Source-address: 12.12.12.1
MVR Max Multicast Groups: 1024
MVR Hw Rt Limit: 508
MVR Current Multicast Groups: 255

Switch# show mvr groups
VLAN  Interface      Group-Address      Uptime    Expires-time
10    eth-0-2         238.255.0.1        00:03:23 00:02:03
10    eth-0-2         238.255.0.2        00:02:16 00:02:03
10    eth-0-2         238.255.0.3        00:02:16 00:02:03
10    eth-0-2         238.255.0.4        00:02:16 00:02:03
10    eth-0-2         238.255.0.5        00:02:16 00:02:03
10    eth-0-2         238.255.0.6        00:02:16 00:02:04
10    eth-0-2         238.255.0.7        00:02:16 00:02:04
10    eth-0-2         238.255.0.8        00:02:16 00:02:04
10    eth-0-2         238.255.0.9        00:02:16 00:02:04
10    eth-0-2         238.255.0.10       00:02:16 00:02:04
.....
10    eth-0-2         238.255.0.64       00:01:50 00:02:29
```

6.6.3 Application cases

N/A

7 Security Configuration Guide

7.1 Configuring Port Security

7.1.1 Overview

Function Introduction

Port security feature is used to limit the number of “secure” MAC addresses learnt on a particular interface. The interface will forward packets only with source MAC addresses that match these secure addresses. The secure MAC addresses can be created manually, or learnt automatically. After the number of secure MAC addresses reaches the limit for the number of secure MAC addresses, new MAC address can't be learnt or configured on the interface. If the interface then receives a packet with a source MAC address that is different with any of the secure addresses, it is considered as a security violation and should be discarded.

Port security feature also binds a MAC to a port so that the port does not forward packets with source addresses that are outside of defined addresses. If a MAC address configured or learnt on a secure port attempts to access another port, this is also considered as a security violation.

Two types of secure MAC addresses are supported:

- Static secure MAC addresses: These are manually configured by the interface configuration command "switchport port-security mac-address".
- Dynamic secure MAC addresses: These are dynamically learnt.

If a security violation occurs, the packets to be forwarded will be dropped. User can configure the action by command "switchport port-security violation". There are three actions can be chosen:

- errdisable: discard the packet and set the port to errdisable status. Please reference to Ethernet configuration guide, chapter errdisable.
- protect: discard only.

- restrict: discard and record the event in log.

Principle Description

N/A

7.1.2 Configuration

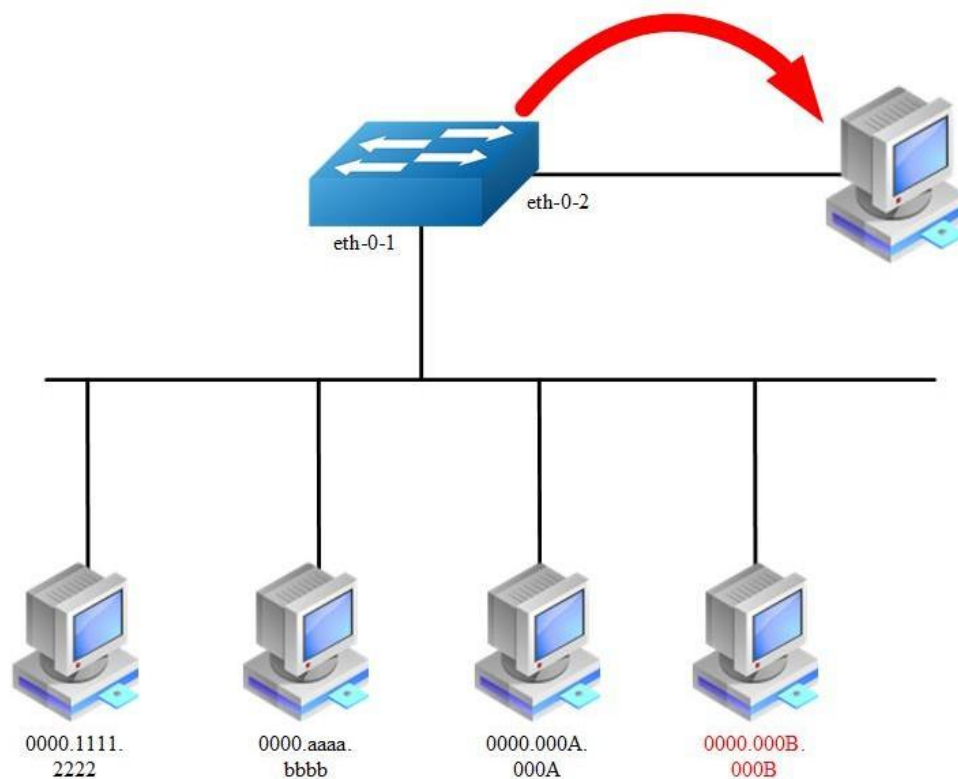

Figure 7-1 Port Security

According to the topology above, only receive three Mac entries and discard source mac 0000.000B.000B after the following configuration:

step 1 Enter the configure mode

```
Switch# configure terminal
```

step 2 Enter the interface configure mode , set the attributes, and enable pim-sm

```
Switch(config)# interface eth-0-1
Switch(config-if)# switchport
```

```
Switch(config-if)# switchport port-security
Switch(config-if)# switchport port-security maximum 2
Switch(config-if)# switchport port-security mac-address 0000.1111.2222 vlan 1
Switch(config-if)# switchport port-security violation restrict
Switch(config-if)# exit
```

step 3 Exit the configure mode

```
Switch(config)# end
```

step 4 Validation

```
Switch# show port-security
Secure Port  MaxSecureAddr  CurrentAddr  SecurityViolationMode
      (Count)          (DynamicCount)
-----
eth-0-1      2                2            restrict

Switch# show port-security address-table
Secure MAC address table
-----
Vlan    Mac Address          Type                Ports
----    -
1       0000.1111.2222      SecureConfigured   eth-0-1
1       0000.aaaa.bbbb      SecureLearned       eth-0-1
1       0000.000a.000a      SecureLearned       eth-0-1

Switch# show port-security interface eth-0-1
Port security                : enabled
Violation mode                : discard packet and log
Maximum dynamic MAC addresses : 2
Total MAC addresses           : 3
Static configured MAC addresses : 1
```

7.1.3 Application cases

N/A

7.2 Configuring Vlan Security

7.2.1 Overview

Function Introduction

Vlan security feature is used to limit the total number of MAC addresses learnt in a particular vlan. The MAC addresses can be added manually, or learnt automatically.

After the device reaches the limit for the number of MAC addresses on the vlan, if the vlan receives a packet with an unknown source MAC address, the configured action will take effect.

Two types of MAC addresses are supported:

- Static MAC addresses: These are manually configured by users.
- Dynamic MAC addresses: These are dynamically learnt.

User can set the action for unknown source MAC packets after the MAC address table count exceed max by using command line "vlan X mac-limit action". Three types of actions are supported:

- Discard: Packet with an unknown source MAC address from the vlan will be discarded and its source MAC address will not be learnt.
- Warn: Packet with an unknown source MAC address from the vlan will be discarded, its source MAC address will not be learnt, but warning log will be printed in syslog.
- Forward: Packets from the vlan will be forwarded without MAC learning or warning log.

MAC address learning feature can be enabled or disabled per-VLAN.

Principle Description

N/A

7.2.2 Configuration

Configuring vlan mac-limit

step 1 Enter the configure mode

```
Switch# configure terminal
```

step 2 Enter the vlan configure mode and create vlan, set the the maximum of MAC addresses and the action at exceeding

```
Switch# configure terminal
Switch(config)# vlan database
Switch(config)# vlan 2
```



```
Switch(config-vlan)# vlan 2 mac-limit maximum 100
Switch(config-vlan)# vlan 2 mac-limit action discard
Switch(config-vlan)# exit
```

step 3 Exit the configure mode

```
Switch(config)# end
```

step 4 Validation

```
Switch# show vlan-security
Vlan  learning-en  max-mac-count  cur-mac-count  action
-----
2     Enable       100            0              Discard
```

Configuring vlan mac learning

step 1 Enter the configure mode

```
Switch# configure terminal
```

step 2 Enter the vlan configure mode and create vlan, set the mac learning states

```
Switch(config)# vlan database
Switch(config)# vlan 2
Switch(config-vlan)# vlan 2 mac learning disable
Switch(config-vlan)# exit
```

step 3 Exit the configure mode

```
Switch(config)# end
```

step 4 Validation

```
Switch# show vlan-security
Vlan  learning-en  max-mac-count  cur-mac-count  action
-----
2     Disable       100            0              Discard
```

7.2.3 Application cases

N/A

7.3 Configuring Time-Range

7.3.1 Overview

Function Introduction

A time range is created that defines specific absolute times or periodic times of the day and week in order to implement time-based function, such as ACLs. The time range is identified by a name and then referenced by a function, which by itself has no relevance. Therefore, the time restriction is imposed on the function itself. The time range relies on the system clock.

Principle Description

N/A

7.3.2 Configuration

Create an absolute time range

step 1 Enter the configure mode

```
Switch# configure terminal
```

step 2 Create a time-range and set absolute time

```
Switch(config)# time-range test-absolute  
Switch(config-tm-range)# absolute start 1:1:2 jan 1 2012 end 1:1:3 jan 7 2012  
Switch(config-tm-range)# exit
```

step 3 Exit the configure mode

```
Switch(config)# end
```

step 4 Validation

```
DUT1# show time-range  
time-range test-absolute  
absolute start 01:01:02 Jan 01 2012 end 01:01:03 Jan 07 2012
```

Create a periodic time range

step 1 Enter the configure mode

```
Switch# configure terminal
```

step 2 Create a time-range and set periodic time

```
Switch(config)# time-range test-periodic  
Switch(config-tm-range)# periodic 1:1 mon to 1:1 wed  
Switch(config-tm-range)# exit
```

step 3 Exit the configure mode

```
Switch(config)# end
```

step 4 Validation

```
DUT1# show time-range  
time-range test-periodic  
    periodic 01:01 Mon to 01:01 Wed
```

7.3.3 Application cases

N/A

7.4 Configuring ACL

7.4.1 Overview

Function Introduction

Access control lists (ACLs) classify traffic with the same characteristics. The ACL can have multiple access control entries (ACEs), which are commands that match fields against the contents of the packet. ACLs can filter packets received on interface by many fields such as ip address, mac address and deny or permit the packets.

Principle Description

The following terms and concepts are used to describe ACL:

- **Access control entry (ACE):** Each ACE includes an action element (permit or deny) and a series of filter element based on criteria such as source address, destination address, protocol, and protocol-specific parameters.
- **MAC ACL:** MAC ACL can filter packet by mac-sa and mac-da, and the mac-address can be masked, or configured as host id, or configured as any to filter all MAC addresses. MAC ACL can also filter other L2 fields such as COS, VLAN-ID, INNER-COS, INNER-VLAN-ID, L2 type, L3 type.
- **IPv4 ACL:** IPv4 ACL can filter packet by ip-sa and ip-da, and ip-address can be masked, or configured as host id, or configured as any to filter all IPv4 address. IPv4 ACL can also filter other L3 fields such as DSCP, L4 protocol and L4 fields such as TCP port, UDP port, and so on.
- **Time Range:** Time range can define a period of time only between which the ACE can be valid if the ACE is associated to the time range.

7.4.2 Configuration

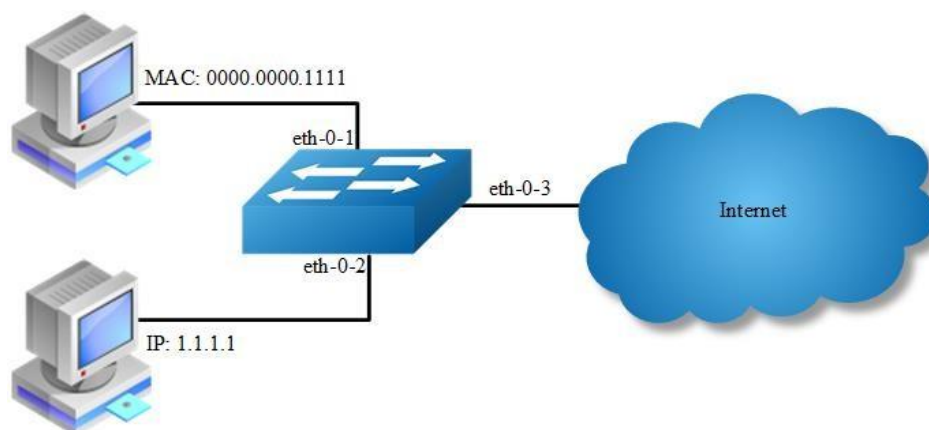

Figure 7-2 acl

In this example, use MAC ACL on interface eth-0-1, to permit packets with source mac 0000.0000.1111 and deny any other packets. Use IPv4 ACL on interface eth-0-2, to permit packets with source ip 1.1.1.1/24 and deny any other packets.

step 1 Enter the configure mode

```
Switch# configure terminal
```

step 2 Create access list

mac access list:

```
Switch(config)# mac access-list mac
Switch(config-mac-acl)# permit src-mac host 0000.0000.1111 dest-mac any
Switch(config-mac-acl)# deny src-mac any dest-mac any
Switch(config-mac-acl)# exit
```

ip access list:

```
Switch(config)# ip access-list ipv4
Switch(config-ip-acl)# permit any 1.1.1.1 0.0.0.255 any
Switch(config-ip-acl)# deny any any any
Switch(config-ip-acl)# exit
```

step 3 Create class-map, and bind the access list

```
Switch(config)# class-map cmap1
Switch(config-cmap)# match access-group mac
Switch(config-cmap)# exit

Switch(config)# class-map cmap2
Switch(config-cmap)# match access-group ipv4
Switch(config-cmap)# exit
```

step 4 Create policy-map and bind the class map

```
Switch(config)# policy-map pmap1
Switch(config-pmap)# class cmap1
Switch(config-pmap-c)# exit
Switch(config-pmap)# exit

Switch(config)# policy-map pmap2
Switch(config-pmap)# class cmap2
Switch(config-pmap-c)# exit
Switch(config-pmap)# exit
```

step 5 Apply the policy to the interface

```
Switch(config)# interface eth-0-1
Switch(config-if)# service-policy input pmap1
Switch(config-if)# exit

Switch(config-if)# interface eth-0-2
Switch(config-if)# service-policy input pmap2
Switch(config-if)# exit
```

step 6 Exit the configure mode

```
Switch(config)# end
```

step 7 Validation

The result of show running-config is as follows:

```
Switch# show running-config
mac access-list mac
  10 permit src-mac host 0000.0000.1111 dest-mac any
  20 deny src-mac any dest-mac any
!
ip access-list ipv4
  10 permit any 1.1.1.0 0.0.0.255 any
  20 deny any any any
!
class-map match-any cmap1
  match access-group mac
!
class-map match-any cmap2
  match access-group ipv4
!
policy-map pmap1
  class cmap1
!
policy-map pmap2
  class cmap2
!
interface eth-0-1
  service-policy input pmap1
!
interface eth-0-2
  service-policy input pmap2
!
```

7.4.3 Application cases

N/A

7.5 Configuring Extern ACL

7.5.1 Overview

Function Introduction

Extend IPv4 ACL combines MAC filters with IP filters in one access list. Different from MAC and IP ACL, extend ACL can access-control all packets (IP packets and non-IP packets). Extend ACL supported extend IPv4 ACL.

Principle Description

Following is a brief description of terms and concepts used to describe the extend ACL :

- **Extend IPv4 ACL:** Extend IPv4 ACL takes advantages of MAC ACL and IPv4 ACL, which combines MAC ACE with IPv4 ACE in an ACL to provide more powerful function of access-controlling traverse packets.
- **MAC ACE:** Filter packets by mac-sa and mac-da, and the mac-address can be masked, or configured as host id, or configured as any to filter all MAC addresses. Other L2 fields, such as COS, VLAN-ID, INNER-COS, INNER-VLAN-ID, L2 type, L3 type, can also be filtered by MAC ACE.
- **IPv4 ACE:** Filter packets by ip-sa and ip-da, and ip-address can be masked, or configured as host id, or configured as any to filter all IPv4 address. Other L3 fields such as DSCP, L4 protocol and L4 fields, such as TCP port, UDP port, can also be filtered by IPv4 ACE.

The MAC ACE and IPv4 ACE in an extend IPv4 ACL can be configured alternately in arbitrary order which is completely specified by user.

7.5.2 Configuration

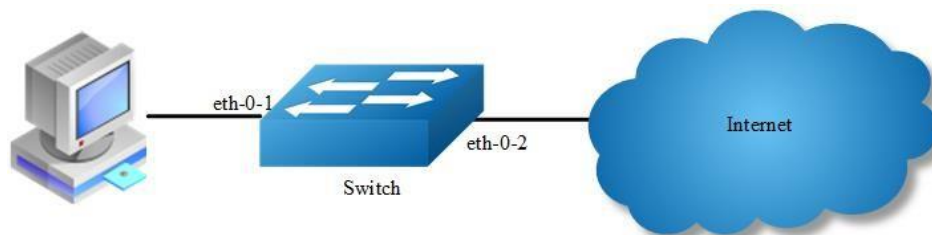

Figure 7-3 extern acl

In this example, use extend IPv4 ACL on interface eth-0-1, to permit packets with source mac 0000.0000.1111 and cos value of 2, permit all TCP packets, and deny any other packets.

step 1 Enter the configure mode

```
Switch# configure terminal
```

step 2 Create access list

```
Switch(config)# ip access-list ipxacl extend
Switch(config-ex-ip-acl)# permit src-mac host 0000.0000.1111 dest-mac any cos 2
Switch(config-ex-ip-acl)# permit tcp any any
Switch(config-ex-ip-acl)# deny src-mac any dest-mac any
Switch(config-ex-ip-acl)# end
```

step 3 Create class-map, and bind the access list

```
Switch(config)# class-map cmap
Switch(config-cmap)# match access-group ipxacl
Switch(config-cmap)# exit
```

step 4 Create policy-map and bind the class map

```
Switch(config)# policy-map pmap
Switch(config-pmap)# class cmap
Switch(config-pmap-c)# exit
Switch(config-pmap)# exit
```

step 5 Apply the policy to the interface

```
Switch(config)# interface eth-0-1
Switch(config-if)# service-policy input pmap
Switch(config-if)# exit
```

step 6 Exit the configure mode

```
Switch(config)# end
```

step 7 Validation

The result of show running-config is as follows:

```
Switch# show running-config
ip access-list ipxacl extend
  10 permit src-mac host 0000.0000.1111 dest-mac any cos 2
  20 permit tcp any any
  30 deny src-mac any dest-mac any
!
class-map match-any cmap
  match access-group ipxacl
!
policy-map pmap
  class cmap
!
interface eth-0-1
  service-policy input pmap
!
```



```
Switch# show access-list ip
ip access-list ipxACL extend
 10 permit src-mac host 0000.0000.1111 dest-mac any cos 2
 20 permit tcp any any
 30 deny src-mac any dest-mac any
```

7.5.3 Application cases

N/A

7.6 Configuring IPv6 ACL

7.6.1 Overview

Function Introduction

Access control lists for IPv6 (ACLv6) classify traffic with the same characteristics. The ACLv6 can have multiple access control entries (ACEs), which are commands that match fields against the contents of the packet. ACLv6 can filter packets received on interface by many fields such as ipv6 address and deny or permit the packets.

Principle Description

The following terms and concepts are used to describe ACLv6.

- **Access control entry (ACE):** Each ACE includes an action element (permit or deny) and a filter element based on criteria such as source address, destination address, protocol, and protocol-specific parameters.
- **IPv6 ACL:** IPv6 ACL can filter packet by ipv6-sa and ipv6-da, and ipv6-address can be masked, or configured as host id, or configured as any to filter all IPv6 address. IPv6 ACL can also filter other L3 fields such as L4 protocol and L4 fields such as TCP port, UDP port, and so on.
- **Time Range:** Time range can define a period of time only between which the ACE can be valid if the ACE is associated to the time range.

7.6.2 Configuration

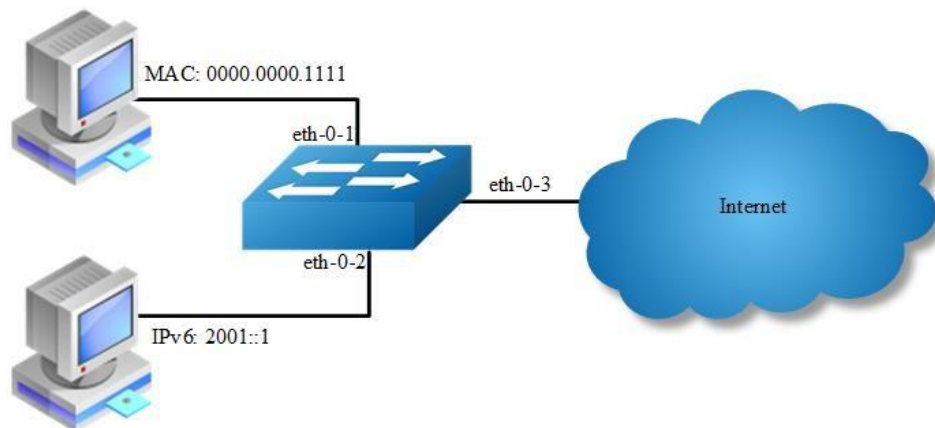

Figure 7-4 ipv6 acl

step 1 Enter the configure mode

```
Switch# configure terminal
```

step 2 Enable IPv6 globally

```
Switch(config)# ipv6 enable
```

step 3 Create access list

mac access list:

```
Switch(config)# mac access-list mac
Switch(config-mac-acl)# permit src-mac host 0000.0000.1111 dest-mac any
Switch(config-mac-acl)# deny src-mac any dest-mac any
Switch(config-mac-acl)# exit
```

ipv6 access list:

```
Switch(config)# ipv6 access-list ipv6
Switch(config-ipv6-acl)# permit any 2001::/64 any
Switch(config-ipv6-acl)# deny any any any
Switch(config-ipv6-acl)# exit
```

step 4 Create class-map, and bind the access list

```
Switch(config)# class-map cmap1
Switch(config-cmap)# match access-group mac
Switch(config-cmap)# exit

Switch(config)# class-map cmap2
```

```
Switch(config-cmap)# match access-group ipv6
Switch(config-cmap)# exit
```

step 5 Create policy-map and bind the class map

```
Switch(config)# policy-map pmap1
Switch(config-pmap)# class cmap1
Switch(config-pmap-c)# exit
Switch(config-pmap)# exit

Switch(config)# policy-map pmap2
Switch(config-pmap)# class cmap2
Switch(config-pmap-c)# exit
Switch(config-pmap)# exit
```

step 6 Apply the policy to the interface

```
Switch(config)# interface eth-0-1
Switch(config-if)# service-policy input pmap1
Switch(config-if)# exit

Switch(config-if)# interface eth-0-2
Switch(config-if)# service-policy input pmap2
Switch(config-if)# exit
```

step 7 Exit the configure mode

```
Switch(config)# end
```

step 8 Validation

If IPv6 is enabled globally, the IPv6 packet will not obey the MAC ACL rules:

```
Switch# show running-config
mac access-list mac
  10 permit src-mac host 0000.0000.1111 dest-mac any
  20 deny src-mac any dest-mac any
!
ipv6 access-list ipv6
  10 permit any 2001::/64 any
  20 deny any any any
!
class-map match-any cmap1
  match access-group mac
!
class-map match-any cmap2
  match access-group ipv4
!
policy-map pmap1
  class cmap1
!
policy-map pmap2
```

```
class cmap2
!
interface eth-0-1
  service-policy input pmap1
!
interface eth-0-2
  service-policy input pmap2
!
```

7.6.3 Application cases

N/A

7.7 Configuring Port-Group

7.7.1 Overview

Function Introduction

Port-group is designed to implement a port group based on ACL rules. Multiple interfaces can be added to the port group, supporting physical interfaces and aggregation interfaces. When the user applies ACL policy to the port group, there's only one rule and the action of ACL has an aggregate effect.

Principle Description

N/A

7.7.2 Configuration

Create a port group

step 1 Enter the configure mode

```
Switch# configure terminal
```

step 2 Create a port group and add member interfaces

```
Switch(config)# port-group port_group_1
Switch(config-port-group)# member interface eth-0-1
```

```
Switch(config-port-group)# member interface agg 1
Switch(config-port-group)# exit
```

step 3 Exit the configure mode

```
Switch(config)# end
```

step 4 Validation

```
DUT1# show running-config port-group
port-group port_group_1
  member interface eth-0-1
  member interface agg1
```

7.7.3 Application cases

N/A

7.8 Configuring Vlan-Group

7.8.1 Overview

Function Introduction

Vlan-group is designed to implement a vlan group based on ACL rules. Multiple vlan can be added to the vlan group. When the user applies ACL policy to the vlan group, there's only one rule and the action of ACL has a aggregate effect.

Principle Description

N/A

7.8.2 Configuration

Create a vlan group

step 1 Enter the configure mode

```
Switch# configure terminal
```

step 2 Create a vlan group and add member vlan

```
Switch(config)# vlan-group vlan_group_1
Switch(config-vlan-group)# member vlan 10
Switch(config-vlan-group)# member vlan 20
Switch(config-vlan-group)# exit
```

step 3 Exit the configure mode

```
Switch(config)# end
```

step 4 Validation

```
DUT1# show running-config vlan-group
vlan-group vlan_group_1
    member vlan 10
    member vlan 20
```

7.8.3 Application cases

N/A

7.9 Configuring COPP ACL

7.9.1 Overview

Function Introduction

COPP is mainly used to discard or limit the rate of the packets which is transmitted to cpu. It guarantees that cpu can deal with traffic normally. In the base of original exception, copp can make a careful control of the packets transmitted to cpu.

Principle Description

The following terms and concepts are used to describe ACL: - **Access control entry (ACE)**: Each ACE includes an action element (permit or deny) and a series of filter element based on criteria such as source address, destination address, protocol, and protocol-specific parameters. - **COPP ACL**:COPP ACL deals with packets according to their exceptions, the system can support the following exceptions: any,ipda, fwd-to-cpu, slow-protocol, bpdu, erps, eapol, smart-link, dhcp, rip,ospf, pim, bgp, vrrp, ldp, ptp, rsvp, icmp-redirect, mcast-rpf-fail,macsa-mismatch,vlan-security-discard,

post-security-discard, ip-option, udd, dot1x-mac-bypass, 12protocol-tunnel, arp, igmp, ssh, telnet, mlag. COPP only deals with the packets transmitted to cpu, it will not handle the forwarding packets. - **Time Range:** Time range can define a period of time only between which the ACE can be valid if the ACE is associated to the time range.

7.9.2 Configuration

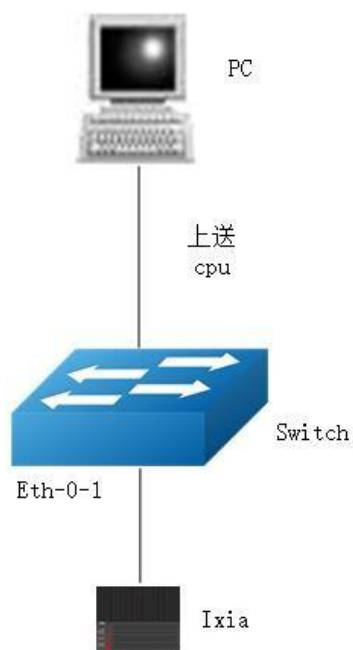

Figure 7-5 copp_acl

In this example, use COPP ACL on interface eth-0-1, to discard the packets with arp exception transmitted to cpu. In the first place, you can use ixia to create a packet, Destination Address:001E.0811.065D, Source Address:0000.0010.0000, the type of arp is arp-request, Sender Hardware Address:0000.0000.0000, Target Protocol Address:10.0.0.1, the rest configuration information is as follows.

step 1 Enter the configure mode

```
Switch# configure terminal
```

step 2 Create copp access list

copp access list:

```
Switch(config)# control-plane access-list test1
Switch(config-cp-acl)# deny exception arp arp-request
Switch(config-cp-acl)# exit
```

step 3 Create class-map, and bind the copp access list

```
Switch(config)# class-map type control-plane cmap1
Switch(config-cmap-cp)# match access-group test1
Switch(config-cmap-cp)# exit
```

step 4 Create policy-map and bind the class map

```
Switch(config)#policy-map type control-plane pmap1
Switch(config-pmap-cp)#class type control-plane cmap1
Switch(config-pmap-cp-c)#exit
Switch(config-pmap-cp)#exit
```

step 5 Apply the policy to the interface

```
Switch(config)#control-plane
Switch(config-control-plane)#service-policy type control-plane input pmap1
```

step 6 Exit the configure mode

```
Switch(config)# end
```

step 7 Validation

The result of show running-config is as follows:

```
Switch# show running-config
control-plane access-list test1
  10 deny exception arp arp-request
!
class-map type control-plane cmap1
  match access-group test1
!
policy-map type control-plane pmap1
  class type control-plane cmap1
!
control-plane
  service-policy type control-plane input pmap1
```

The result of show cpu traffic-statistics receive is as follows:

```
Switch# show cpu traffic-statistics receive

statistics rate time is 5 second(s)

reason          count (packets)      rate (pps)
```

arp	1029059	0
total	1029059	0

7.9.3 Application cases

N/A

7.10 Configuring dot1x

7.10.1 Overview

Function Introduction

IEEE 802 Local Area Networks are often deployed in environments that permit unauthorized devices to be physically attached to the LAN infrastructure, or Permit unauthorized users to attempt to access the LAN through equipment already attached.

Port-based network access control makes use of the physical access characteristics of IEEE 802 LAN infrastructures in order to provide a means of authenticating and authorizing devices attached to a LAN port that has point-to-point connection characteristics, and of preventing access to that port in cases in which the authentication and authorization process fails.

With 802.1X port-based authentication, the devices in the network have specific roles:

- Client: the device (PC) that requests access to the LAN and switch services and responds to requests from the switch. The client software with support the follow the 802.1X standard should run on the PC. For linux system, we recommend the application which named "xsupplicant".
- Authentication server: performs the actual authentication of the client. The authentication server validates the identity of the client and notifies the switch whether or not the client is authorized to access the LAN and switch services. Because the switch acts as the proxy, the authentication service is transparent to the client. In this release, the Remote Authentication Dial-In User Service (RADIUS) security system with Extensible Authentication Protocol (EAP) extensions is the only supported authentication server. RADIUS operates

in a client/server model in which secure authentication information is exchanged between the RADIUS server and one or more RADIUS clients.

- **Switch (edge switch or wireless access point):** controls the physical access to the network based on the authentication status of the client. The switch acts as an intermediary (proxy) between the client and the authentication server, requesting identity information from the client, verifying that information with the authentication server, and relaying a response to the client. The switch includes the RADIUS client, which is responsible for encapsulating and decapsulation the EAP frames and interacting with the authentication server. When the switch receives EAPOL frames and relays them to the authentication server, the Ethernet header is stripped and the remaining EAP frame is re-encapsulated in the RADIUS format. The EAP Frames are not modified or examined during encapsulation, and the authentication server must support EAP within the native frame format. When the switch receives frames from the authentication server, the server's frame header is removed, leaving the EAP frame, which is then encapsulated for Ethernet and sent to the client. We can enable dot1x on routed port and access port.

Principle Description

Reference to IEEE Std 802.1X- 2004

7.10.2 Configuration

Basic dot1x configuration

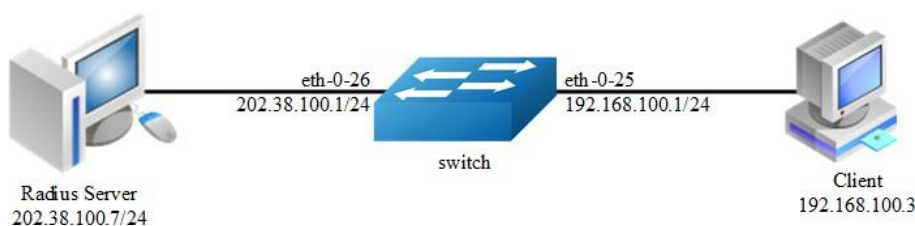

Figure 7-6 dot1x

step 1 Enter the configure mode

```
Switch# configure terminal
```

step 2 Enable dot1x globally

```
Switch(config)# dot1x system-auth-ctrl
```

step 3 Enter the interface configure mode, set the attributes of the interface and enable dot1x

```
Switch(config)# interface eth-0-25
Switch(config-if)# switchport mode access
Switch(config-if)# dot1x port-control auto
Switch(config-if)# no shutdown
Switch(config-if)# exit

Switch(config)# interface vlan 1
Switch(config-if)# ip address 192.168.100.1/24
Switch(config-if)# exit
```

step 4 Set the attributes of Layer 3 interface and set the Radius server

```
Switch(config)# interface eth-0-26
Switch(config-if)# no switchport
Switch(config-if)# ip address 202.38.100.1/24
Switch(config-if)# no shutdown
Switch(config-if)# exit

Switch(config)# radius-server host 202.38.100.7
Switch(config)# radius-server host 2001:1000::1
Switch(config)# radius-server key test
Switch(config)# exit
```

step 5 Exit the configure mode

```
Switch(config)# end
```

step 6 Validation

```
Switch# show dot1x
802.1X Port-Based Authentication Enabled
  RADIUS server address: 2001:1000::1:1812
  Next radius message ID: 0
  RADIUS server address: 202.38.100.7:1812
  Next radius message ID: 0
Switch# show dot1x interface eth-0-25
802.1X info for interface eth-0-25
  portEnabled           : true
  portControl           : Auto
  portMode              : Port based
  portStatus            : Authorized
  Mac Auth bypass      : disabled
  reAuthenticate        : disabled
```

```

reAuthPeriod          : 3600
Max user number       : 255
Current session number : 1
Accept user number    : 1
Reject user number     : 0
Guest VLAN            : N/A
Assign VLAN           : N/A
QuietPeriod           : 60
ReqMax                : 2
TxPeriod              : 30
SuppTimeout           : 30
ServerTimeout         : 30
CD: adminControlledDirections : in
CD: operControlledDirections  : in
CD: bridgeDetected           : false
=====
session 1: 1 - 0011.0100.0001
-----
user name : admin
abort:F fail:F start:F timeout:F success:T
PAE: state: Authenticated - portMode: Auto
PAE: reAuthCount: 0 - rxRespId: 0
BE: state: Idle - reqCount: 0 - idFromServer: 5

```

Enable dot1x on routed port

The example above describes how to enable dot1x on access port. This function can also enable on routed port. The following example shows how to change eth-0-25 to a routed port and enable dot1x.

```

Switch(config)# interface eth-0-25
Switch(config-if)# no switchport
Switch(config-if)# ip address 192.168.100.1/24
Switch(config-if)# dot1x port-control auto
Switch(config-if)# no shutdown
Switch(config-if)# exit

```

Using force mode

Dot1x port control mode can be force-authorized or force-unauthorized.

force-authorized:

```

Switch(config)# interface eth-0-25
Switch(config-if)# dot1x port-control force-authorized
Switch(config-if)# exit

```

force-unauthorized:

```
Switch(config)# interface eth-0-25
Switch(config-if)# dot1x port-control force-unauthorized
Switch(config-if)# exit
```

User can choose port control mode as force-authorized,force-unauthorized or auto. The final configuration should over write the previous one.

Enable dot1x accounting

Dot1x accounting can be used to keep track of network usage after user is authenticated. Dot1x accounting is disabled by default, you can enable it on globally configure mode.

Enable dot1x accounting:

```
Switch(config)# dot1x accounting-mode radius
```

Device sends accounting start request to server after user is authenticated when dot1x accounting is enabled, if no corresponding response is received, start-fail policy is needed :

- **online:** In order to avoid the impact of network failure on users, online policy can be configured to allow users to be online.
- **offline:** If dot1x accounting start fail, offline policy can be configured to reject users to be online.

```
Switch(config)# dot1x accounting start-fail online
```

User can configure realtime accounting to make device send realtime accounting request to server periodically. Server keeps accounting users only when received realtime accounting request, so that abnormal accounting can be avoided when server can not receive accounting stop packet from device.

Meanwhile, user can configure max times of realtime accounting with no response and the action when realtime accounting fails. By default, the max times of realtime accounting with no response is set to 3, and user is allowed to be online after realtime accounting failure.

```
Switch(config)# dot1x accounting realtime 60
Switch(config)# dot1x accounting interim-fail max-times 2 offline
```

dot1x optional parameter

Timer for Radius server: Set the wait time for re-activating RADIUS server; Set the maximum failed RADIUS requests sent to server; Set the timeout value for no response from RADIUS server.

```
Switch(config)# radius-server deadtime 10
Switch(config)# radius-server retransmit 5
Switch(config)# radius-server timeout 10
```

Interface attributes: Specify the number of reauthentication attempts before becoming unauthorized; Set the protocol version; Specify the quiet period in the HELD state; Enable reauthentication on a port; Specify the seconds between reauthorization attempts; Specify the authentication server response timeout; Specify the supplicant response timeout; Specify the Seconds between successive request ID attempts;

Enable dot1x handshake with client on a port; Specify the handshake period.

```
Switch(config)# interface eth-0-25
Switch(config-if)# dot1x max-req 5
Switch(config-if)# dot1x protocol-version 1
Switch(config-if)# dot1x quiet-period 120
Switch(config-if)# dot1x reauthentication
Switch(config-if)# dot1x timeout re-authperiod 1800
Switch(config-if)# dot1x timeout server-timeout 60
Switch(config-if)# dot1x timeout supp-timeout 60
Switch(config-if)# dot1x timeout tx-period 60
Switch(config-if)# dot1x handshake
Switch(config-if)# dot1x timeout handshake-period 1
Switch(config-if)# exit
```

7.10.3 Application cases

Radius server configuration (Using WinRadius for example)

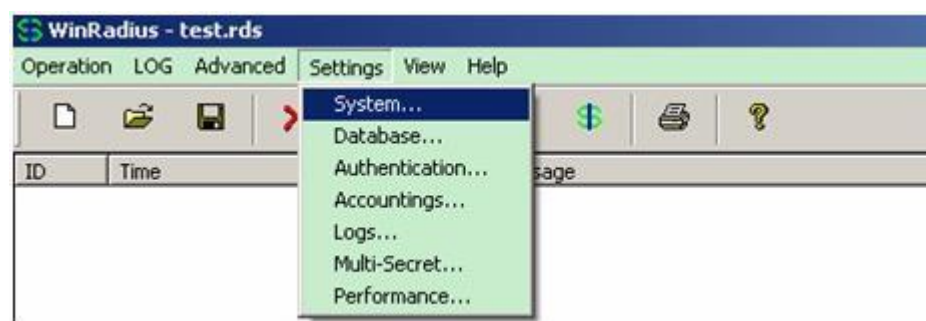
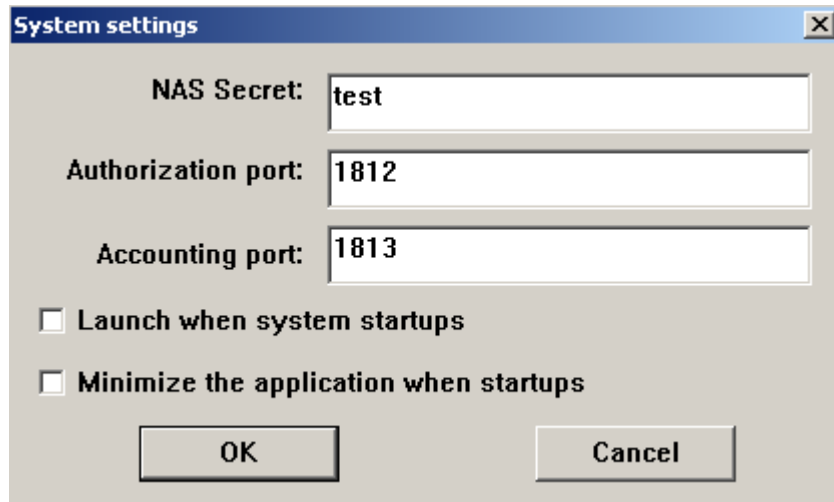

Figure 7-7 Select "Setting-> System"



The 'System settings' dialog box contains the following fields and options:

- NAS Secret: test
- Authorization port: 1812
- Accounting port: 1813
- Launch when system startups
- Minimize the application when startups
- Buttons: OK, Cancel

Figure 7-8 Configure the shared-key, authorization port and account port

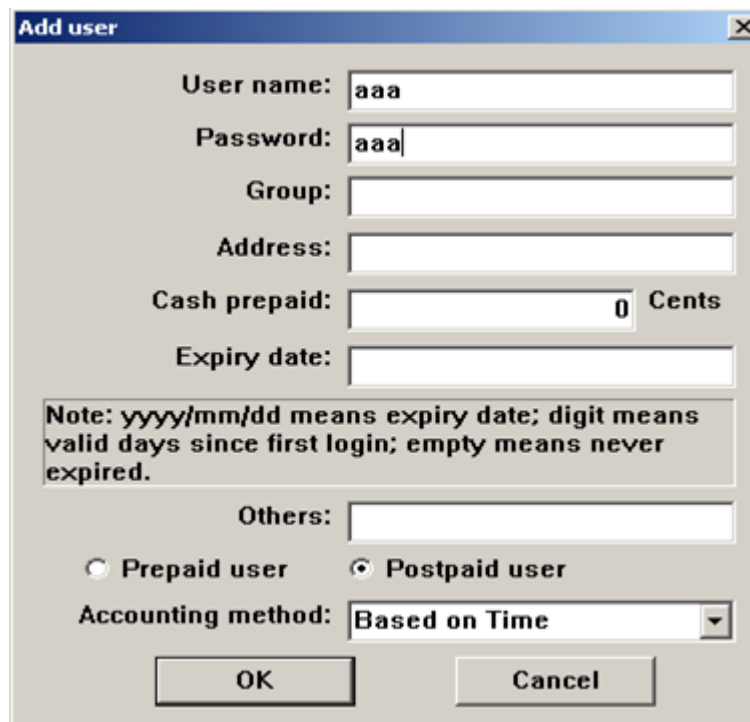

The 'Add user' dialog box contains the following fields and options:

- User name: aaa
- Password: aaa
- Group:
- Address:
- Cash prepaid: 0 Cents
- Expiry date:
- Note: yyyy/mm/dd means expiry date; digit means valid days since first login; empty means never expired.
- Others:
- Prepaid user Postpaid user
- Accounting method: Based on Time
- Buttons: OK, Cancel

Figure 7-9 Add user name and password on the server

7.11 Configuring Guest VLAN

7.11.1 Overview

Function Introduction

You can configure a guest VLAN for each 802.1x port on the switch to provide limited services to clients (for example, how to download the 802.1x client). These clients might be upgrading their system for 802.1x authentication, and some hosts, such as Windows 98 systems, might not be 802.1x-capable.

When the authentication server does not receive a response to its EAPOL request/identity frame, clients that are not 802.1x-capable are put into the guest VLAN for the port, if one is configured. However, the server does not grant 802.1x-capable clients that fail authentication access to the network. Any number of hosts is allowed access when the switch port is moved to the guest VLAN.

The guest VLAN feature is not supported on internal VLANs (routed ports) or trunk ports; it is supported only on access ports.



NOTE

Guest VLAN is supported on access port, and not supported on routed port or trunk port.

Principle Description

无

7.11.2 Configuration

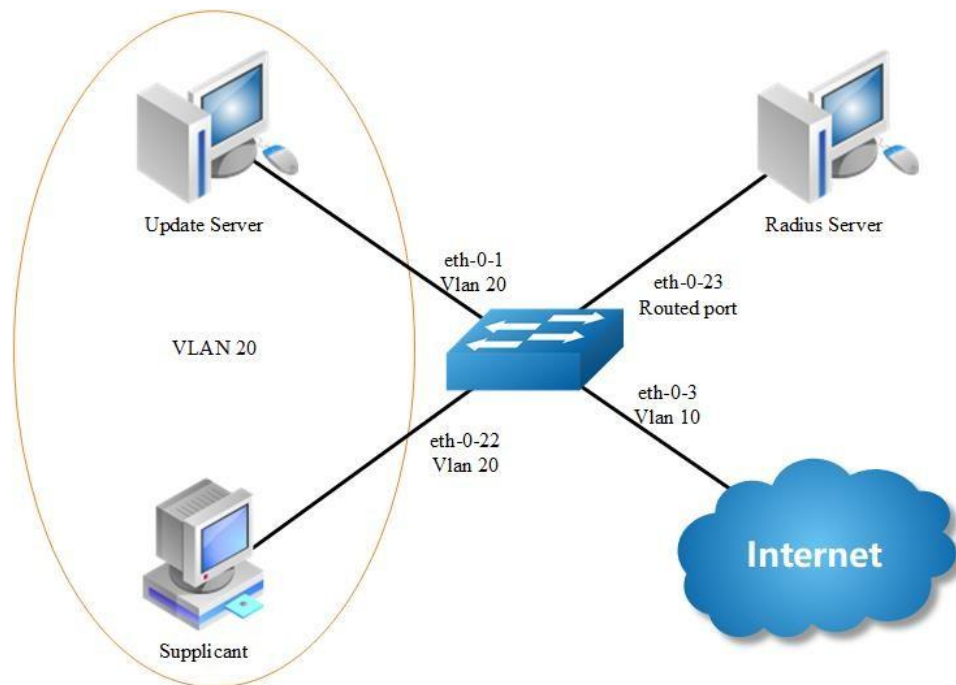

Figure 7-10 Guest vlan: before authenticated

In the above topology, eth-0-22 is an IEEE 802.1X enabled port, and it is in the native VLAN 10, the configured guest VLAN for this port is VLAN 20. So clients that are not 802.1X capable will be put into VLAN 20 after the authenticator had send max EAPOL request/identity frame but got no response.

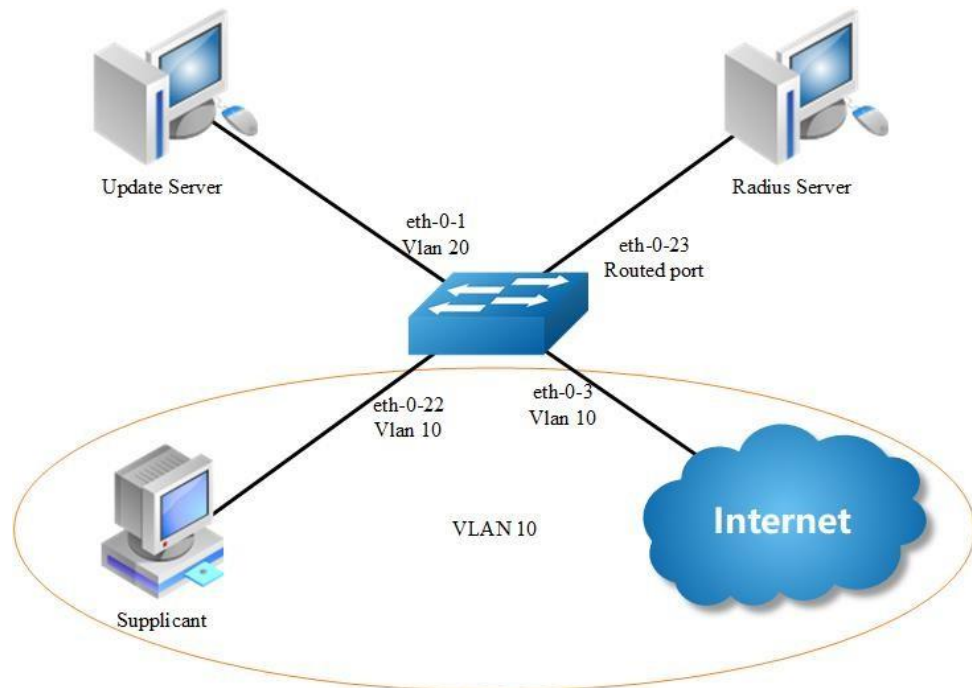

Figure 7-11 Guest vlan: after authenticated

We use remote linux Radius server as authenticate server, the server's address is 202.38.100.7, and the IP address for the connected routed port eth-0-23 is 202.38.100.1. When the client is authenticated by the radius server, then it can access the public internet which is also in VLAN 10.

step 1 Enter the configure mode

```
Switch# configure terminal
```

step 2 Enter the vlan configure mode and create vlan

```
Switch(config)# vlan database
Switch(config-vlan)# vlan 10
Switch(config-vlan)# vlan 20
Switch(config-vlan)# exit
```

step 3 Enable dot1x globally

```
Switch(config)# dot1x system-auth-ctrl
```

step 4 Enter the interface configure mode, set the attributes of the interface and enable dot1x and set guest vlan

```
Switch(config)# interface eth-0-22
Switch(config-if)# switchport mode access
Switch(config-if)# switchport access vlan 10
Switch(config-if)# dot1x port-control auto
Switch(config-if)# no shutdown
Switch(config-if)# dot1x guest vlan 20
Switch(config-if)# exit
```

step 5 Set the attributes of Layer 3 interface and set the Radius server

```
Switch(config)# interface eth-0-23
Switch(config-if)# no switchport
Switch(config-if)# ip address 202.38.100.1/24
Switch(config-if)# no shutdown
Switch(config-if)# exit

Switch(config)# radius-server host 202.38.100.7
Switch(config)# radius-server key test
Switch(config)#end
```

step 6 Exit the configure mode

```
Switch(config)# end
```

step 7 Validation

Init state:

```
Switch# show running-config
dot1x system-auth-ctrl
radius-server host 202.38.100.7 key test
vlan database
vlan 10,20
!
interface eth-0-22
switchport access vlan 10
dot1x port-control auto
dot1x guest-vlan 20
!
interface eth-0-23
no switchport
ip address 202.38.100.1/24
!

Switch# show dot1x interface eth-0-22
802.1X info for interface eth-0-22
portEnabled          : true
portControl          : Auto
```

```

portMode           : Port based
portStatus         : Unauthorized
Mac Auth bypass    : disabled
reAuthenticate     : disabled
reAuthPeriod       : 3600
Max user number    : 255
Current session number : 0
Accept user number : 0
Reject user number : 0
Guest VLAN         : 20
Assign VLAN        : N/A
QuietPeriod        : 60
ReqMax             : 2
TxPeriod           : 30
SuppTimeout        : 30
ServerTimeout      : 30
CD: adminControlledDirections : in
CD: operControlledDirections  : in
CD: bridgeDetected           : false
=====

Switch# show vlan brief
VLAN ID  Name           State   STP ID  DSCP    Member ports
          (u)-Untagged, (t)-Tagged
=====
1        default     ACTIVE  0       Disable eth-0-1(u) eth-0-2(u)
          eth-0-3(u) eth-0-4(u)
          eth-0-5(u) eth-0-6(u)
          eth-0-7(u) eth-0-8(u)
          eth-0-9(u) eth-0-10(u)
          eth-0-11(u) eth-0-12(u)
          eth-0-13(u) eth-0-14(u)
          eth-0-15(u) eth-0-16(u)
          eth-0-17(u) eth-0-18(u)
          eth-0-19(u) eth-0-20(u)
          eth-0-21(u) eth-0-24(u)
          eth-0-25(u) eth-0-26(u)
          eth-0-27(u) eth-0-28(u)
          eth-0-29(u) eth-0-30(u)
          eth-0-31(u) eth-0-32(u)
          eth-0-33(u) eth-0-34(u)
          eth-0-35(u) eth-0-36(u)
          eth-0-37(u) eth-0-38(u)
          eth-0-39(u) eth-0-40(u)
          eth-0-41(u) eth-0-42(u)
          eth-0-43(u) eth-0-44(u)
          eth-0-45(u) eth-0-46(u)
          eth-0-47(u) eth-0-48(u)
10       VLAN0010     ACTIVE  0       Disable eth-0-22(u)
20       VLAN0020     ACTIVE  0       Disable

```

After configure the guest vlan:

unauthorized:

```

Switch# show dot1x interface eth-0-22
802.1X info for interface eth-0-22
  portEnabled          : true
  portControl          : Auto
  portMode             : Port based
  portStatus          : Unauthorized
  Mac Auth bypass     : disabled
  reAuthenticate       : disabled
  reAuthPeriod        : 3600
  Max user number     : 255
  Current session number : 1
  Accept user number  : 0
  Reject user number  : 1
  Guest VLAN          : 20 (Port Authorized by guest vlan)
  Assign VLAN         : N/A
  QuietPeriod         : 60
  ReqMax              : 2
  TxPeriod            : 30
  SuppTimeout         : 30
  ServerTimeout       : 30
  CD: adminControlledDirections : in
  CD: operControlledDirections  : in
  CD: bridgeDetected           : false
=====

session 1: 1 - 0011.0100.0001
-----
user name : admin
  abort:F fail:T start:F timeout:F success:F
  PAE: state: Held - portMode: Auto
  PAE: reAuthCount: 1 - rxRespId: 0
  BE: state: Idle - reqCount: 0 - idFromServer: 92

Switch# show vlan brief
VLAN ID  Name          State   STP ID  DSCP    Member ports
          (u)-Untagged, (t)-Tagged
=====
1         default      ACTIVE  0       Disable eth-0-1 (u) eth-0-2 (u)
          eth-0-3 (u) eth-0-4 (u)
          eth-0-5 (u) eth-0-6 (u)
          eth-0-7 (u) eth-0-8 (u)
          eth-0-9 (u) eth-0-10 (u)
          eth-0-11 (u) eth-0-12 (u)
          eth-0-13 (u) eth-0-14 (u)
          eth-0-15 (u) eth-0-16 (u)
          eth-0-17 (u) eth-0-18 (u)
          eth-0-19 (u) eth-0-20 (u)
          eth-0-21 (u) eth-0-24 (u)
          eth-0-25 (u) eth-0-26 (u)
          eth-0-27 (u) eth-0-28 (u)
          eth-0-29 (u) eth-0-30 (u)
          eth-0-31 (u) eth-0-32 (u)
          eth-0-33 (u) eth-0-34 (u)
          eth-0-35 (u) eth-0-36 (u)
          eth-0-37 (u) eth-0-38 (u)

```

```

eth-0-39 (u) eth-0-40 (u)
eth-0-41 (u) eth-0-42 (u)
eth-0-43 (u) eth-0-44 (u)
eth-0-45 (u) eth-0-46 (u)
eth-0-47 (u) eth-0-48 (u)
10 VLAN0010 ACTIVE 0 Disable
20 VLAN0020 ACTIVE 0 Disable eth-0-22 (u)
Client is authenticated

```

authorized:

```

Switch# show dot1x interface eth-0-22
802.1X info for interface eth-0-22
portEnabled      : true
portControl      : Auto
portMode         : Port based
portStatus       : Authorized
Mac Auth bypass  : disabled
reAuthenticate   : disabled
reAuthPeriod     : 3600
Max user number  : 255
Current session number : 1
Accept user number : 1
Reject user number : 0
Guest VLAN       : 20
Assign VLAN      : N/A
QuietPeriod      : 60
ReqMax           : 2
TxPeriod         : 30
SuppTimeout      : 30
ServerTimeout    : 30
CD: adminControlledDirections : in
CD: operControlledDirections  : in
CD: bridgeDetected           : false
=====

session 1: 1 - 0011.0100.0001
-----
user name : admin
abort:F fail:F start:F timeout:F success:T
PAE: state: Authenticated - portMode: Auto
PAE: reAuthCount: 0 - rxRespId: 0
BE: state: Idle - reqCount: 0 - idFromServer: 207

Switch# show vlan brief
VLAN ID Name          State  STP ID  DSCP  Member ports
              (u)-Untagged, (t)-Tagged
=====
1          default    ACTIVE  0      Disable eth-0-1 (u) eth-0-2 (u)
              eth-0-3 (u) eth-0-4 (u)
              eth-0-5 (u) eth-0-6 (u)
              eth-0-7 (u) eth-0-8 (u)
              eth-0-9 (u) eth-0-10 (u)
              eth-0-11 (u) eth-0-12 (u)
              eth-0-13 (u) eth-0-14 (u)
              eth-0-15 (u) eth-0-16 (u)

```

```

eth-0-17 (u) eth-0-18 (u)
eth-0-19 (u) eth-0-20 (u)
eth-0-21 (u) eth-0-24 (u)
eth-0-25 (u) eth-0-26 (u)
eth-0-27 (u) eth-0-28 (u)
eth-0-29 (u) eth-0-30 (u)
eth-0-31 (u) eth-0-32 (u)
eth-0-33 (u) eth-0-34 (u)
eth-0-35 (u) eth-0-36 (u)
eth-0-37 (u) eth-0-38 (u)
eth-0-39 (u) eth-0-40 (u)
eth-0-41 (u) eth-0-42 (u)
eth-0-43 (u) eth-0-44 (u)
eth-0-45 (u) eth-0-46 (u)
eth-0-47 (u) eth-0-48 (u)
10      VLAN0010      ACTIVE  0      Disable eth-0-22 (u)
20      VLAN0020      ACTIVE  0      Disable

Switch# show dot1x
802.1X Port-Based Authentication Enabled
  RADIUS server address: 202.38.100.7:1812
  Next radius message ID: 0
Switch# show dot1x statistics
=====
802.1X statistics for interface eth-0-22
  EAPOL Frames Rx: 52 - EAPOL Frames Tx: 4270
  EAPOL Start Frames Rx: 18 - EAPOL Logoff Frames Rx: 2
  EAP Rsp/Id Frames Rx: 29 - EAP Response Frames Rx: 3
  EAP Req/Id Frames Tx: 3196 - EAP Request Frames Tx: 3
  Invalid EAPOL Frames Rx: 0 - EAP Length Error Frames Rx: 0
  EAPOL Last Frame Version Rx: 2 - EAPOL Last Frame Src: ae38.3288.f046

```

7.11.3 Application cases

N/A

7.12 Configuring ARP Inspection

7.12.1 Overview

Function Introduction

ARP inspection is a security feature that validates ARP packets in a network. ARP inspection intercepts, logs, and discards ARP packets with invalid IP-to-MAC address bindings. This capability protects the network from some man-in-the-middle attacks. ARP inspection ensures that only valid ARP requests and responses are relayed. The switch performs these activities:

Intercept all ARP requests and responses on untrusted ports.

Verify that each of these intercepted packets has a valid IP-to-MAC address binding before updating the local ARP cache or before forwarding the packet to the appropriate destination.

Drop invalid ARP packets.

ARP inspection determines the validity of an ARP packet based on valid IP-to-MAC address bindings stored in a trusted database, the DHCP snooping binding database. This database is built by DHCP snooping if DHCP snooping is enabled on the VLANs and on the switch. If the ARP packet is received on a trusted interface, the switch forwards the packet without any checks. On entrusted interfaces, the switch forwards the packet only if it is valid.

Principle Description

Following is a brief description of terms and concepts used to describe the ARP Inspection:

- **DHCP Snooping:** DHCP snooping is a security feature that acts like a firewall between untrusted hosts and trusted DHCP servers. This feature builds and maintains the DHCP snooping binding database, which contains information about untrusted hosts with leased IP addresses.
- **Address Resolution Protocol (ARP):** ARP provides IP communication within a Layer 2 broadcast domain by mapping an IP address to a MAC address. For example, Host B wants to send information to Host A, but it does not have the MAC address of Host A in its ARP cache. Host B generates a broadcast message for all hosts within the broadcast domain to obtain the MAC address associated with the IP address of Host A. All hosts within the broadcast domain receive the ARP request, and Host A responds with its MAC address.

7.12.2 Configuration

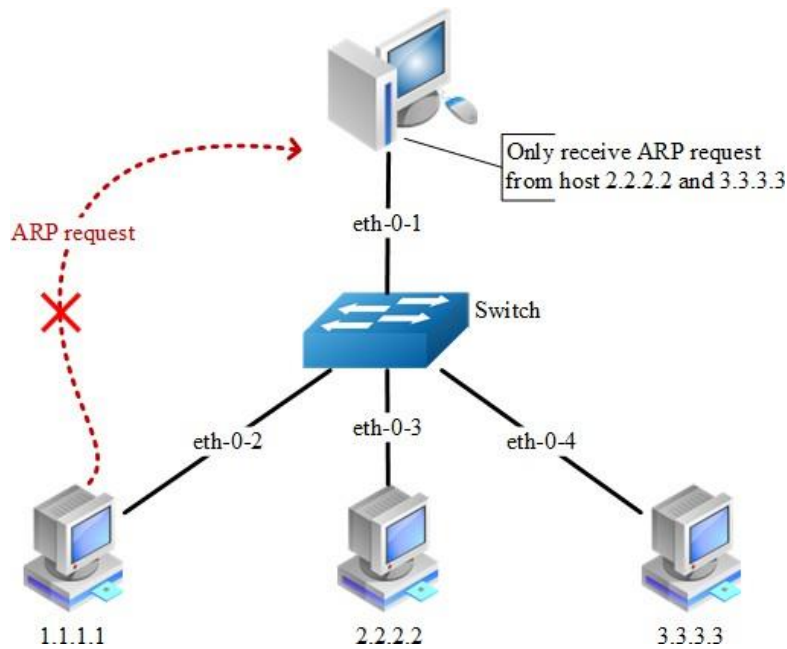

Figure 7-12 arp inspection

step 1 Enter the configure mode

```
Switch# configure terminal
```

step 2 Enter the vlan configure mode and create vlan

```
Switch(config)# vlan database
Switch(config-vlan)# vlan 2
Switch(config-vlan)# exit
Switch(config)# exit
```

step 3 Enter the interface configure mode, add the interface into the vlan

```
Switch(config)# interface eth-0-1
Switch(config-if)# switchport access vlan 2
Switch(config-if)# exit

Switch(config)# interface eth-0-2
Switch(config-if)# switchport access vlan 2
Switch(config-if)# exit

Switch(config)# interface eth-0-3
Switch(config-if)# switchport access vlan 2
Switch(config-if)# exit
```

```
Switch(config)# interface eth-0-4
Switch(config-if)# switchport access vlan 2
Switch(config-if)# exit
```

step 4 Configure arp inspection

```
Switch(config)# interface eth-0-1
Switch(config-if)# ip arp inspection trust
Switch(config-if)# exit
Switch(config)# ip arp inspection vlan 2
Switch(config)# ip arp inspection validate src-mac ip dst-mac
```

step 5 Configure arp access list

```
Switch(config)# arp access-list test
Switch(config-arp-acl)# deny request ip host 1.1.1.1 mac any
Switch(config-arp-acl)# exit
Switch(config)# ip arp inspection filter test vlan 2
```

step 6 Exit the configure mode

```
Switch(config)# exit
```

step 7 Validation

Check the configuration of ARP Inspection on switch:

```
Switch# show ip arp inspection
Source Mac Validation      : Enabled
Destination Mac Validation : Enabled
IP Address Validation      : Enabled
Vlan      Configuration    ACL Match    Static ACL
=====
2         enabled          test
Vlan      ACL Logging      DHCP Logging
=====
2         deny            deny
Vlan      Forwarded      Dropped      DHCP Drops    ACL Drops
=====
2         0              0            0             0
Vlan      DHCP Permits    ACL Permits    Source MAC Failures
=====
2         0              0            0
Vlan      Dest MAC Failures  IP Validation Failures  Invalid Protocol Data
=====
2         0              0            0
```

Show the log information of ARP Inspection on switch:

```
Switch# show ip arp inspection log
Total Log Buffer Size : 32
Syslog rate : 5 entries per 1 seconds.
```

```
1970-01-02 00:30:47 : Drop an ARP packet by ACL on vlan 2
1970-01-02 00:30:47 : Drop an ARP packet by ACL on vlan 2
1970-01-02 00:30:47 : Drop an ARP packet by ACL on vlan 2
1970-01-02 00:30:47 : Drop an ARP packet by ACL on vlan 2
1970-01-02 00:30:47 : Drop an ARP packet by ACL on vlan 2
1970-01-02 00:30:47 : Drop an ARP packet by ACL on vlan 2
1970-01-02 00:30:47 : Drop an ARP packet by ACL on vlan 2
1970-01-02 00:30:47 : Drop an ARP packet by ACL on vlan 2
1970-01-02 00:30:47 : Drop an ARP packet by ACL on vlan 2
1970-01-02 00:30:47 : Drop an ARP packet by ACL on vlan 2
1970-01-02 00:30:47 : Drop an ARP packet by ACL on vlan 2
1970-01-02 00:30:47 : Drop an ARP packet by ACL on vlan 2
```

7.12.3 Application cases

N/A

7.13 Configuring DHCP Snooping

7.13.1 Overview

Function Introduction

DHCP snooping is a security feature that acts like a firewall between untrusted hosts and trusted DHCP servers.

The DHCP snooping feature performs the following activities:

- Validate DHCP messages received from untrusted sources and filters out invalid messages.
- Build and maintain the DHCP snooping binding database, which contains information about untrusted hosts with leased IP addresses.
- Utilize the DHCP snooping binding database to validate subsequent requests from untrusted hosts.

Other security features, such as dynamic ARP inspection (DAI), also use information stored in the DHCP snooping binding database. DHCP snooping is enabled on a per-VLAN basis. By default, the feature is inactive on all VLANs. You can enable the feature on a single VLAN or a range of VLANs. The DHCP snooping feature is implemented in software basis. All DHCP messages are intercepted in the BAY and directed to the CPU for processing.

Principle Description

N/A

7.13.2 Configuration

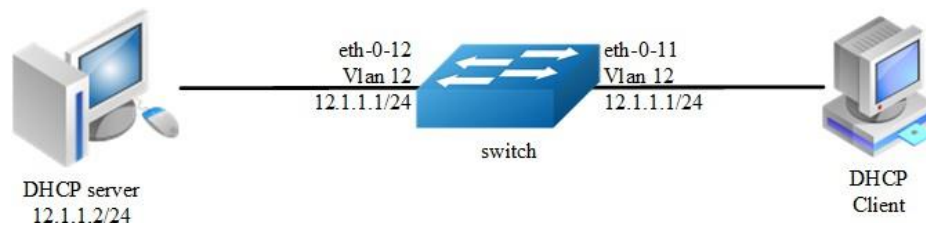

Figure 7-13 dhcp snooping

This figure is the networking topology for testing DHCP snooping functions. We need two Linux boxes and one switch to construct the test bed.

- Computer A is used as a DHCP server.
- Computer B is used as a DHCP client.
- Switch is used as a DHCP Snooping box.

step 1 Enter the configure mode

```
Switch# configure terminal
```

step 2 Enter the vlan configure mode and create vlan

```
Switch(config)# vlan database
Switch(config-vlan)# vlan 12
Switch(config-vlan)# exit
```

step 3 Enter the interface configure mode, add the interface into the vlan

```
Switch(config)# interface eth-0-12
Switch(config-if)# switchport
Switch(config-if)# switchport access vlan 12
Switch(config-if)# dhcp snooping trust
Switch(config-if)# no shutdown
Switch(config-if)# exit

Switch(config)# interface eth-0-11
Switch(config-if)# switchport
Switch(config-if)# switchport access vlan 12
Switch(config-if)# no shutdown
Switch(config-if)# exit
```

```
Switch(config)# interface vlan 12
Switch(config-if)# ip address 12.1.1.1/24
Switch(config-if)# exit
```

step 4 Set DHCP attributes

```
Switch(config)# dhcp snooping verify mac-address
Switch(config)# service dhcp enable
Switch(config)# dhcp snooping
Switch(config)# dhcp snooping vlan 12
```

step 5 Exit the configure mode

```
Switch(config)# exit
```

step 6 Validation

Check the interface configuration.

```
Switch(config)# show running-config interface eth-0-12
!
interface eth-0-12
  dhcp snooping trust
  switchport access vlan 12
!

Switch(config)# show running-config interface eth-0-11
!
interface eth-0-11
  switchport access vlan 12
!
```

Check the dhcp service status.

```
Switch# show services
Networking services configuration:
Service Name          Status
=====
dhcp                  enable
```

Print dhcp snooping configuration to check current configuration.

```
Switch# show dhcp snooping config
dhcp snooping service: enabled
dhcp snooping switch: enabled
Verification of hwaddr field: enabled
Insertion of relay agent information (option 82): disable
Relay agent information (option 82) on untrusted port: not allowed
dhcp snooping vlan 12
```

Show dhcp snooping statistics.

```
Switch# show dhcp snooping statistics
DHCP snooping statistics:
=====
DHCP packets                17
BOOTP packets                0
Packets forwarded           30
Packets invalid              0
Packets MAC address verify failed 0
Packets dropped              0
```

Show dhcp snooping binding information.

```
Switch# show dhcp snooping binding all
DHCP snooping binding table:
VLAN MAC Address      Interface  Lease(s)   IP Address
=====
12   0016.76a1.7ed9 eth-0-11   691190    12.1.1.65
```

7.13.3 Application cases

N/A

7.14 Configuring IP source guard

7.14.1 Overview

Function Introduction

IP source guard prevents IP spoofing by allowing only the IP addresses that are obtained through DHCP snooping on a particular port. Initially, all IP traffic on the port is blocked except for the DHCP packets that are captured by DHCP snooping. When a client receives a valid IP address from the DHCP server, an access control list (ACL) is installed on the port that permits the traffic from the IP address. This process restricts the client IP traffic to those source IP addresses that are obtained from the DHCP server; any IP traffic with a source IP address other than that in the ACL's permit list is filtered out. This filtering limits the ability of a host to attack the network by claiming a neighbor host's IP address.

IP source guard uses source IP address filtering, which filters the IP traffic that is based on its source IP address. Only the IP traffic with a source IP address that matches the IP source binding entry is permitted. A port's IP source address filter is changed when a new DHCP-snooping binding entry for a port is created or deleted. The port ACL is modified and reapplied in the hardware to reflect the IP source

binding change. By default, if you enable IP source guard without any DHCP-snooping bindings on the port, a default ACL that denies all IP traffic is installed on the port. When you disable IP source guard, any IP source filter ACL is removed from the port.

Also IP source guard can use source IP and MAC address Filtering. When IP source guard is enabled with this option, IP traffic is filtered based on the source IP and Mac addresses. The switch forwards traffic only when the source IP and MAC addresses match an entry in the IP source binding table. If not, the switch drops all other types of packets except DHCP packet.

The switch also supports to have IP, MAC and VLAN Filtering. When IP source guard is enabled with this option, IP traffic is filtered based on the source IP and MAC addresses. The switch forwards traffic only when the source IP, MAC addresses and VLAN match an entry in the IP source binding table.

When ip source guard is enabled on an interface, enable arp as-layer-3 in global configuration mode so that arp packets matching ip source guard entries can be forwarded normally. If it is disabled, the system is discarded, affecting network communication.

Principle Description

The following terms and concepts are used to describe the IP source guard:

- **Dynamic Host Configuration Protocol (DHCP):** Dynamic Host Configuration Protocol (DHCP) is a client/server protocol that automatically provides an Internet Protocol (IP) host with its IP address and other related configuration information such as the subnet mask and default gateway.
- **DHCP Snooping:** DHCP snooping is a security feature that acts like a firewall between untrusted hosts and trusted DHCP servers. This feature builds and maintains the DHCP snooping binding database, which contains information about untrusted hosts with leased IP addresses.
- **ACL:** Access control list.

7.14.2 Configuration

Configure ip source guard

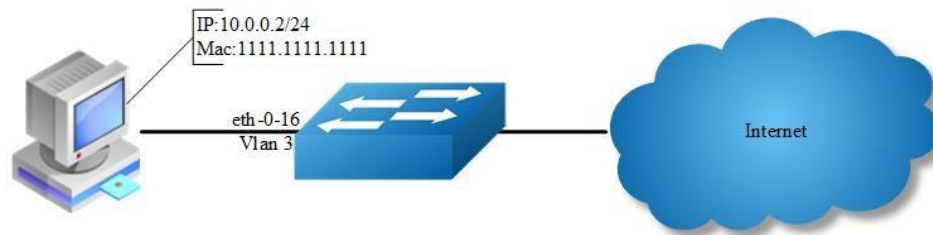

Figure 7-14 ip source guard

step 1 Enter the configure mode

```
Switch# configure terminal
```

step 2 Enable arp as-layer-3

```
Switch(config)# arp as-layer-3 enable
```

step 3 Enter the vlan configure mode and create vlan

```
Switch(config)# vlan database  
Switch(config-vlan)# vlan 3  
Switch(config-vlan)# exit
```

step 4 Enter the interface configure mode and set the attributes

```
Switch(config)# interface eth-0-16  
Switch(config-if)# switchport  
Switch(config-if)# no shutdown  
Switch(config-if)# switchport access vlan 3  
Switch(config-if)# exit
```

step 5 Add IP source guard entries

```
Switch(config)# ip source maximal binding number per-port 15  
Switch(config)# ip source binding mac 1111.1111.1111 vlan 3 ip 10.0.0.2 interface  
eth-0-16
```

step 6 Enable IP source guard on the interface

```
Switch(config)# interface eth-0-16
Switch(config-if)# ip verify source ip
Switch(config-if)# exit
```

step 7 Exit the configure mode

```
Switch(config)# exit
```

step 8 Validation

```
Switch#show running-config interface eth-0-16
!
interface eth-0-16
 ip verify source ip
 switchport access vlan 3
```

Remove ip source guard entries

Remove by entry:

```
Switch(config)# no ip source binding mac 1111.1111.1111 vlan 3 ip 10.0.0.2
interface eth-0-16
```

Remove by interface:

```
Switch(config)# no ip source binding entries interface eth-0-16
```

Remove by vlan:

```
Switch(config)# no ip source binding entries vlan 3
```

Remove all:

```
Switch(config)# no ip source binding entries
```

7.14.3 Application cases

N/A

7.15 Configuring Private-vlan

7.15.1 Overview

Function Introduction

Private-vlan a security feature which is used to prevent from direct L2 communication among a set of ports in a vlan.

It can provide a safer and more flexible network solutions by isolating the ports which in the same VLAN.

Principle Description

N/A

7.15.2 Configuration

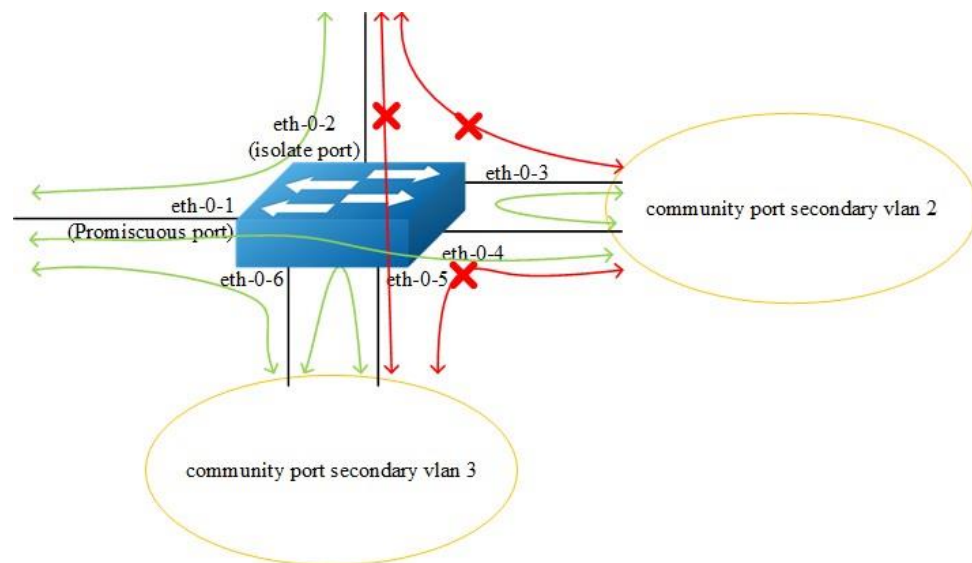

Figure 7-15 private vlan

As the figure above shows:

- All ports are in a same primary vlan.
- Port 1 is promiscuous port; it can communicate with all other ports.
- Port 2 is isolate port; it cannot communicate with all other ports except for the promiscuous port (port 1).

- Port 3 and port 4 are community ports in secondary vlan 2; they can communicate with each other. They cannot communicate with all other ports except for the promiscuous port.
- Port 5 and port6 are community ports in secondary vlan 3; they can communicate with each other. They cannot communicate with all other ports except for the promiscuous port.

step 1 Enter the configure mode

```
Switch# configure terminal
```

step 2 Enter the vlan configure mode and create vlan

```
Switch (config)# vlan database
Switch (config-vlan)# vlan 2
Switch (config-vlan)# quit
```

step 3 Enter the interface configure mode and set the attributes

Promiscuous port: promiscuous port in pvlan can communicate with any other ports in this pvlan

```
Switch (config)# interface eth-0-1
Switch (config-if)# switchport mode private-vlan promiscuous
Switch (config-if)# switchport private-vlan 2
Switch (config-if)# quit
```

Isolate port: isolate port in pvlan can only communicate with promiscuous port in this pvlan

```
Switch (config)# interface eth-0-2
Switch (config-if)# switchport mode private-vlan host
Switch (config-if)# switchport private-vlan 2 isolate
Switch (config-if)# quit
```

Community port: community port in pvlan can communicate with promiscuous port and community ports with same community-vlan id in this pvlan

```
Switch (config)# interface eth-0-3
Switch (config-if)# switchport mode private-vlan host
Switch (config-if)# switchport private-vlan 2 community-vlan 2
Switch (config-if)# quit
```

```
Switch (config)# interface eth-0-4
Switch (config-if)# switchport mode private-vlan host
Switch (config-if)# switchport private-vlan 2 community-vlan 2
Switch (config-if)# quit
```

```
Switch (config)# interface eth-0-5
Switch (config-if)# switchport mode private-vlan host
Switch (config-if)# switchport private-vlan 2 community-vlan 3
Switch (config-if)# quit

Switch (config)# interface eth-0-6
Switch (config-if)# switchport mode private-vlan host
Switch (config-if)# switchport private-vlan 2 community-vlan 3
Switch (config-if)# quit
```

step 4 Exit the configure mode

```
Switch(config)# exit
```

step 5 Validation

The result of show private-vlan is as follows:

```
switch # show private-vlan
Primary   Secondary Type          Ports
-----
2         N/A         promiscuous    eth-0-1
2         N/A         isloate        eth-0-2
2         2          community      eth-0-3 eth-0-4
2         3          community      eth-0-5 eth-0-6
```

7.15.3 Application cases

N/A

7.16 Configuring AAA

7.16.1 Overview

Function Introduction

Authentication verifies users before they are allowed access to the network and network services. System can use AAA authentication methods and Non-AAA authentication methods. RADIUS Authentication is one of AAA authentication methods. RADIUS is a distributed client/server system that secures networks against unauthorized access. RADIUS is widely used protocol in network environments. It is commonly used for embedded network devices such as routers, modem servers, switches, etc. RADIUS clients run on support routers and switches. Clients send

authentication requests to a central RADIUS server, which contains all user authentication and network service access information.

Principle Description

N/A

7.16.2 Configuration

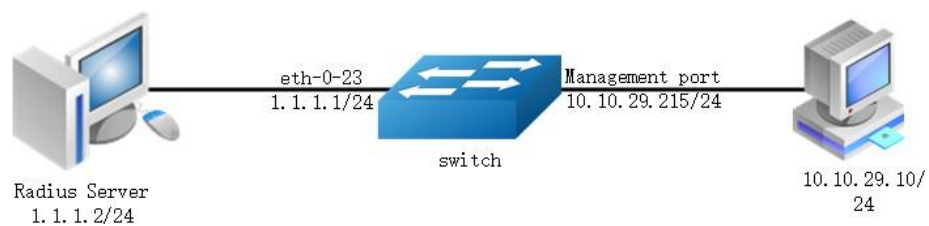

Figure 7-16 private vlan

The figure above is the networking topology for RADIUS authentication functions. We need one Switch and two computers for this test.

One computer as RADIUS server, its ip address of the eth0 interface is 1.1.1.2/24.

Switch has RADIUS authentication function. The ip address of interface eth-0-23 is 1.1.1.1/24. The management ip address of switch is 10.10.29.215, management port is connected to the PC for test login, PC's ip address is 10.10.29.10.

step 1 Enter the configure mode

```
Switch# configure terminal
```

step 2 Enable AAA

```
Switch(config)# aaa new-model
Switch(config)# aaa authentication login radius-login radius local
```

step 3 Configure Radius server

```
Switch(config)# radius-server host 1.1.1.2 auth-port 1819 key keyname
Switch(config)# radius-server host 2001:1000::1 auth-port 1819 key keyname
```

step 4 Configure a layer 3 interface and set ip address

```
Switch(config)# interface eth-0-23
Switch(config-if)# no switchport
Switch(config-if)# ip address 1.1.1.1/24
Switch(config-if)# quit
```

step 5 set authentication mode

```
Switch(config)# line vty 0 7
Switch(config-line)#login authentication radius-login
Switch(config-line)#privilege level 4
Switch(config-line)#no line-password
```

step 6 Exit the configure mode

```
Switch(config-line)# end
```

step 7 Validation

You can use command show authentication status in switch:

```
Switch# show aaa status
aaa status:
    Authentication enable
```

You can use command show keys in switch:

```
Switch# show aaa method-lists authentication
authen queue=AAA_ML_AUTHEN_LOGIN
    Name = default  state = ALIVE :    local
Name = radius-login state = ALIVE :    radius local
```

Telnet output:

A screenshot of a Telnet window titled 'Telnet 10.10.29.215'. The window shows a black background with white text. The text reads: 'User Access Verification', 'Username: aaa', 'Password:', and 'D-215# _'. The window has standard Windows-style window controls (minimize, maximize, close) in the top right corner.

```

User Access Verification
Username: aaa
Password:
D-215# _
```

Figure 7-17 Telnet connecting test



NOTE Don't forget to turn RADIUS authentication feature on.

Make sure the cables is linked correctly You can use command to check log messages if Switch can't do RADIUS authentication:

```
Switch# show logging buffer
```

7.16.3 Application cases

Radius server configuration (Using WinRadius for example)

Set ip address for PC:

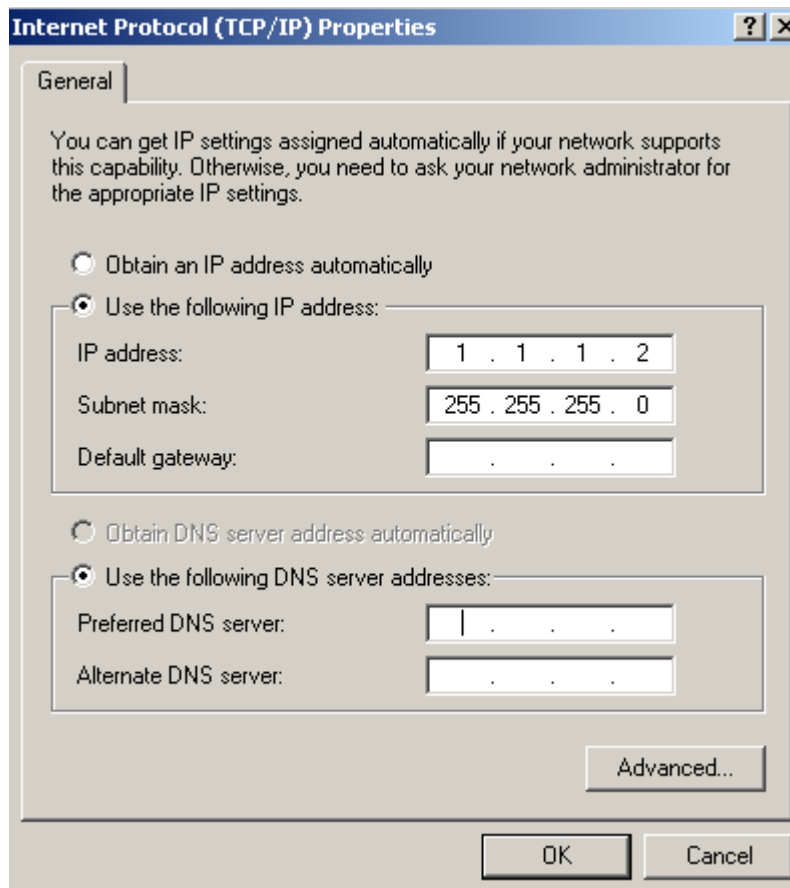
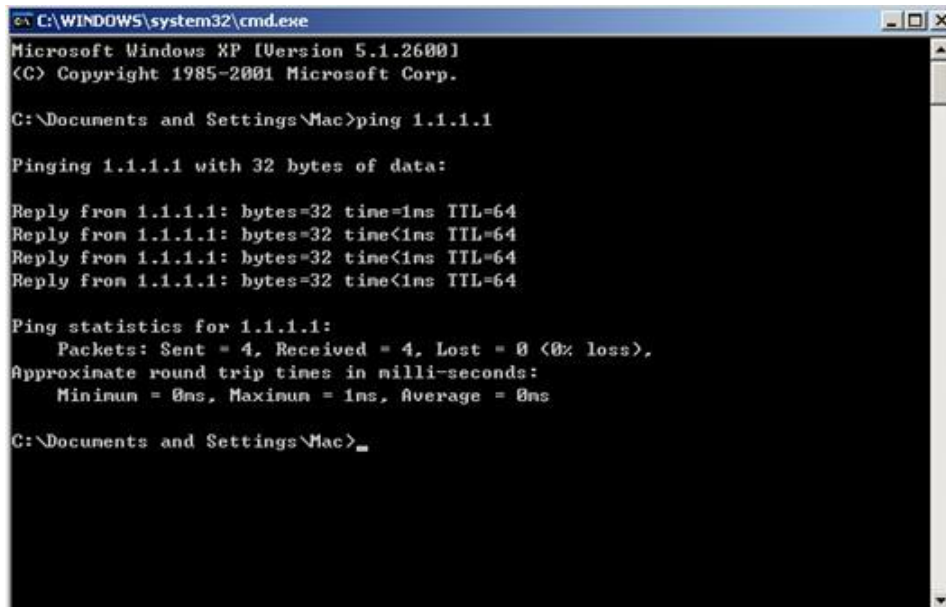

Figure 7-18 Set IP address for PC

Connectivity test between server and switch:



```
C:\WINDOWS\system32\cmd.exe
Microsoft Windows XP [Version 5.1.2600]
(C) Copyright 1985-2001 Microsoft Corp.

C:\Documents and Settings\Mac>ping 1.1.1.1

Pinging 1.1.1.1 with 32 bytes of data:

Reply from 1.1.1.1: bytes=32 time=1ms TTL=64
Reply from 1.1.1.1: bytes=32 time<1ms TTL=64
Reply from 1.1.1.1: bytes=32 time<1ms TTL=64
Reply from 1.1.1.1: bytes=32 time<1ms TTL=64

Ping statistics for 1.1.1.1:
    Packets: Sent = 4, Received = 4, Lost = 0 (0% loss),
    Approximate round trip times in milli-seconds:
        Minimum = 0ms, Maximum = 1ms, Average = 0ms

C:\Documents and Settings\Mac>
```

Figure 7-19 Connectivity test

Open winRadius:

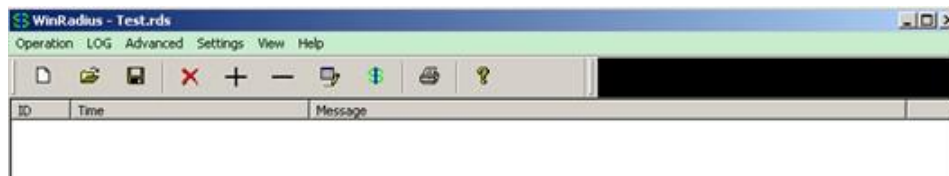

Figure 7-20 WinRadius

Configurations for winRadius:

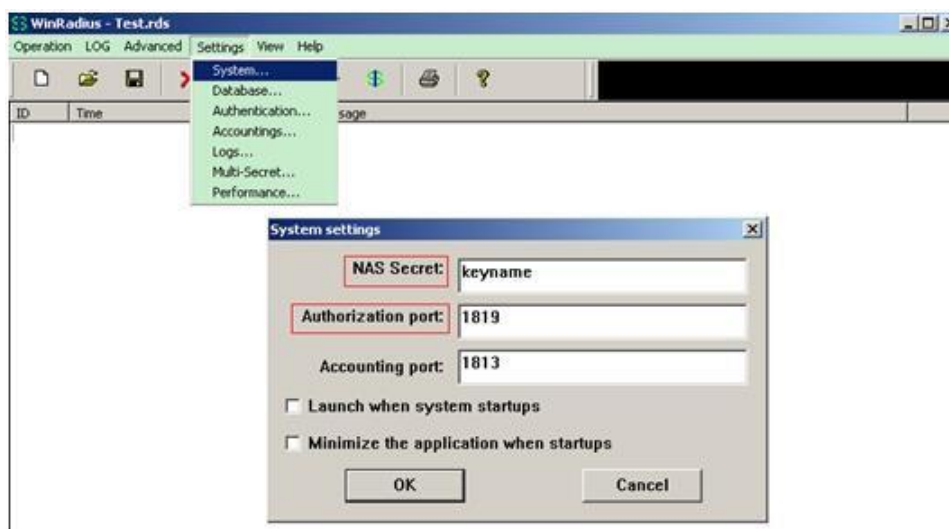

Figure 7-21 WinRadius

Add user and password:

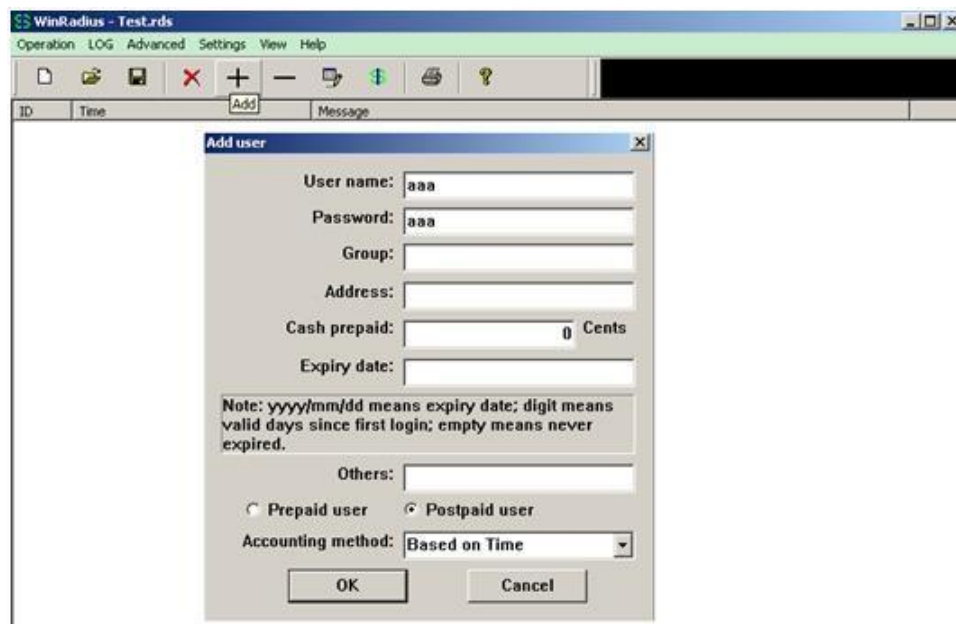

Figure 7-22 Add user and password

Connectivity test between client and switch:

```
C:\Documents and Settings\nac>ping 10.10.29.215

Pinging 10.10.29.215 with 32 bytes of data:

Reply from 10.10.29.215: bytes=32 time<1ms TTL=63
Reply from 10.10.29.215: bytes=32 time<1ms TTL=63
Reply from 10.10.29.215: bytes=32 time<1ms TTL=63
Reply from 10.10.29.215: bytes=32 time<1ms TTL=63

Ping statistics for 10.10.29.215:
    Packets: Sent = 4, Received = 4, Lost = 0 (0% loss),
    Approximate round trip times in milli-seconds:
        Minimum = 0ms, Maximum = 0ms, Average = 0ms
```

Figure 7-23 Connectivity test

7.17 Configuring TACACS+

7.17.1 Overview

Function Introduction

Authentication verifies users before they are allowed access to the network and network services. System can use AAA authentication methods and Non-AAA

authentication methods. TACACS+ Authentication is one of AAA authentication methods. TACACS+ is a distributed client/server system that secures networks against unauthorized access. TACACS+ is widely used protocol in network environments. It is commonly used for embedded network devices such as routers, modem servers, switches, etc. TACACS+ clients run on support routers and switches. Clients send authentication requests to a central TACACS+ server, which contains all user authentication and network service access information.

Principle Description

N/A

7.17.2 Configuration

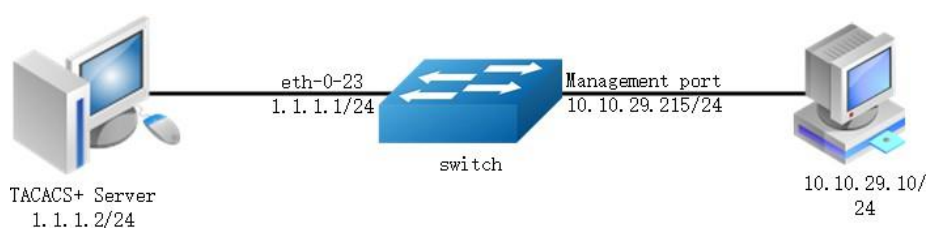

Figure 7-24 TACACS+

The figure above is the networking topology for TACACS+ authentication functions. We need one Switch and two computers for this test. One computer as TACACS+ server, its IP address of the eth0 interface is 1.1.1.2/24. Switch has TACACS+ authentication function. The IP address of interface eth-0-23 is 1.1.1.1/24. The management IP address of switch is 10.10.29.215, management port (only in-band management port) is connected to the PC for test login, PC's IP address is 10.10.29.10

step 1 Enter the configure mode

```
Switch# configure terminal
```

step 2 Enable AAA

```
Switch# configure terminal
Switch(config)# aaa new-model
Switch(config)# aaa authentication login tac-login tacacs-plus local
Switch(config)# aaa authorization exec default tacacs-plus
Switch(config)# aaa accounting exec default start-stop tacacs-plus
Switch(config)# aaa accounting commands default tacacs-plus
```

step 3 Configure tacacs+ server

```
Switch(config)# tacacs-server host 1.1.1.2 port 123 key keyname primary
```

step 4 Configure a layer 3 interface and set ip address

```
Switch(config)# interface eth-0-23
Switch(config-if)# no switchport
Switch(config-if)# ip address 1.1.1.1/24
Switch(config-if)# quit
```

step 5 set authentication mode

```
Switch(config)# line vty 0 7
Switch(config-line)#login authentication tac-login
Switch(config-line)#privilege level 4
Switch(config-line)#no line-password
```

step 6 Exit the configure mode

```
Switch(config-line)# end
```

step 7 Validation

You can use command show authentication status in switch:

```
Switch# show aaa status
aaa stats:
    Authentication enable
```

You can use command show keys in switch:

```
Switch# show aaa method-lists authentication
authen queue=AAA_ML_AUTHEN_LOGIN
    Name = default state = ALIVE : local
Name = tac-login state = ALIVE : tacacs-plus local
```

Telnet output:



Figure 7-25 Telnet connecting test

7.17.3 Application cases

Radius server configuration

Download TACACS+ server code, DEVEL.201105261843.tar.bz2.

Build the TACACS+ server.

Add username and password in configure file.

```
#!/usr/bin/perl
id = spawned {
    listen = { port = 49 }
    spawn = {
        instances min = 1
        instances max = 10
    }
    background = no
}

user = aaa {
    password = clear bbb
    member = guest
}
```

Run TACACS+ server:

```
[discipline: ~]$ ./tac_plus ./tac_plus.cfg.in -d 1
```

Use Ping command for test on PC:

```
C:\Documents and Settings\mac>ping 10.10.29.215

Pinging 10.10.29.215 with 32 bytes of data:

Reply from 10.10.29.215: bytes=32 time<1ms TTL=63
Reply from 10.10.29.215: bytes=32 time<1ms TTL=63
Reply from 10.10.29.215: bytes=32 time<1ms TTL=63
Reply from 10.10.29.215: bytes=32 time<1ms TTL=63

Ping statistics for 10.10.29.215:
    Packets: Sent = 4, Received = 4, Lost = 0 (0% loss),
    Approximate round trip times in milli-seconds:
        Minimum = 0ms, Maximum = 0ms, Average = 0ms
```

Figure 7-26 Connectivity test

7.18 Configuring Port Isolate

7.18.1 Overview

Function Introduction

Port-isolation a security feature which is used to prevent from direct L2/L3 communication among a set of ports.

It can provide a safer and more flexible network solutions by isolating the ports which in the same VLAN.

Generally, it's used as an access device for user isolation.

Principle Description

N/A

7.18.2 Configuration

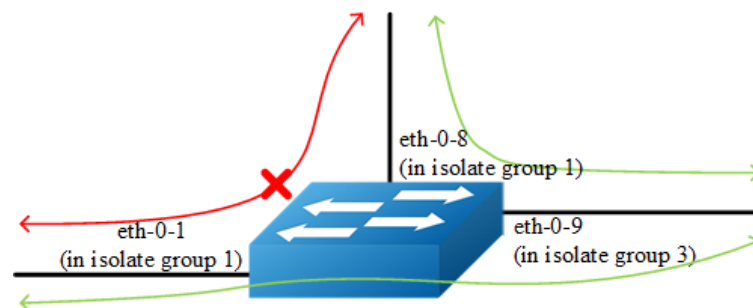

Figure 7-27 Port Isolate

The figure above is the basic topology for port-isolate.

Port 1 and port 8 are in the same isolate group 1, they are isolated. So port1 can not communicate with port 8. Port 9 is in a different isolate group 3, so port 9 can communicate with port 1 and port 8.

step 1 Enter the configure mode

```
Switch# configure terminal
```

step 2 Set the port isolate mode globally

The mode "l2" means only layer 2 packets are isolated. The mode "all" means all packet are isolated include the packets forward according to layer 3 routes.

```
Switch(config)# port-isolate mode l2
```

step 3 Enter the interface configure mode and set isolate group

```
Switch(config-if)# interface eth-0-1
Switch(config-if)# port-isolate group 1
Switch(config-if)# exit
```

```
Switch(config)# interface eth-0-8
Switch(config-if)# port-isolate group 1
Switch(config-if)# exit
```

```
Switch(config)# interface eth-0-9
Switch(config-if)# port-isolate group 3
Switch(config-if)# exit
```

step 4 Exit the configure mode

```
Switch(config)# end
```

step 5 Validation

Use the following command to display the port isolate groups:

```
switch# show port-isolate
```

```
-----
Port Isolate Groups:
-----
```

```
Groups ID: 1
eth-0-1, eth-0-8
```

```
-----
Groups ID: 3
eth-0-9
```

7.18.3 Application cases

N/A

7.19 Configuring DDoS

7.19.1 Overview

Function Introduction

A denial-of-service attack (DoS attack) or distributed denial-of-service attack (DDoS attack) is an attempt to make a computer resource unavailable to its intended users. Although the means to carry out, motives for, and targets of a DoS attack may vary, it generally consists of the concerted efforts of a person or people to prevent an Internet site or service from functioning efficiently or at all, temporarily or indefinitely. Perpetrators of DoS attacks typically target sites or services hosted on high-profile web servers such as banks, credit card payment gateways, and even root name servers. The term is generally used with regards to computer networks, but is not limited to this field, for example, it is also used in reference to CPU resource management.

DDoS prevent is a feature which can protect our switch from follow kinds of denial-of-service attack and intercept the attack packets.

The flowing types are supported:

- ICMP flood: attackers overwhelm the victim with ICMP packets.
- Smurf attack: attackers flood a target system via spoofed broadcast ping messages.
- SYN flood: attackers send a succession of SYN requests to a target's system.
- UDP flood: attackers send a large number of UDP packets to random ports on a remote host.
- Fraggle attack: attackers send a large number of UDP echo traffic to IP broadcast addresses, all fake source address.
- Small-packet: attackers send a large number of small packets to the system until the resource exhaust.
- bad mac intercept: attackers send packets with same source and destination MAC address.
- bad ip equal: attackers send packets with same source and destination IP address.

Principle Description

N/A

7.19.2 Configuration

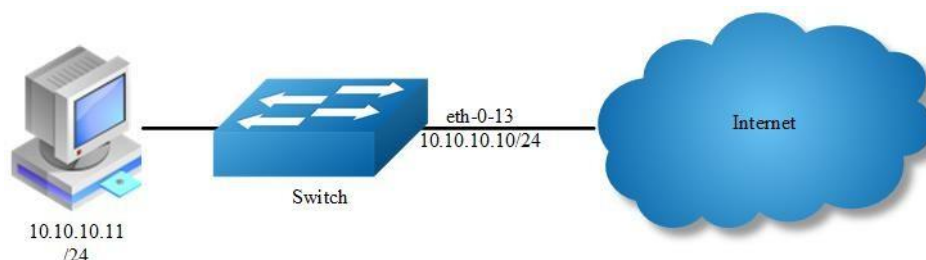

Figure 7-28 Topology for DDoS test

step 1 Enter the configure mode

```
Switch# configure terminal
```

step 2 Set DDoS

Enable ICMP flood intercept and set the max received ICMP packet rate 100 packets per-second

```
Switch(config)# ip icmp intercept maxcount 100
```

Enable UDP flood intercept and set the max received UDP packet rate 100 packets per-second

```
Switch(config)# ip udp intercept maxcount 100
```

Enable Smurf attack intercept

```
Switch(config)# ip smurf intercept
```

Enable SYN flood intercept and set the max received SYN packet rate 100 packets per-second

```
Switch(config)# ip tcp intercept maxcount 100
```

Enable Fraggle attack intercept

```
Switch(config)# ip fraggle intercept
```

Enable Small-packet attack intercept and set the received packet length is be more than or equal to 32

```
Switch(config)# ip small-packet intercept maxlength 32
```

Enable packet source IP equals destination IP intercept

```
Switch(config)# ip ipeq intercept
```

Enable packet source MAC equals destination MAC intercept

```
Switch(config)# ip maceq intercept
```

step 3 Exit the configure mode

```
Switch(config)# end
```

step 4 Validation

```
Switch# show ip-intercept config
Current DDoS Prevent configuration:
=====
ICMP Flood Intercept           :Enable   Maxcount:500
UDP Flood Intercept           :Enable   Maxcount:500
SYN Flood Intercept           :Enable   Maxcount:500
Small-packet Attack Intercept :Enable   Packet Length:45
Smurf Attack Intercept        :Enable
Fraggle Attack Intercept      :Enable
MAC Equal Intercept           :Enable
IP Equal Intercept            :Enable
Switch# show ip-intercept statistics
Current DDoS Prevent statistics:
=====
Resist Small-packet Attack packets number : 1730
Resist ICMP Flood packets number          : 0
Resist SYN Flood packets number           : 0
Resist Fraggle Attack packets number      : 0
Resist UDP Flood packets number           : 0

Current DDoS Prevent mgmt-if statistics:
=====
Resist ICMP Flood packets number          : 0
Resist SYN Flood packets number           : 0
Resist Fraggle Attack packets number      : 0
Resist UDP Flood packets number           : 0
```

7.19.3 Application cases

N/A

7.20 Configuring Key Chain

7.20.1 Overview

Function Introduction

Keychain is a common method of authentication to configure shared secrets on all the entities, which exchange secrets such as keys before establishing trust with each other. Routing protocols and network applications often use this authentication to enhance security while communicating with peers.

The keychain by itself has no relevance; therefore, it must be used by an application that needs to communicate by using the keys (for authentication) with its peers. The keychain provides a secure mechanism to handle the keys and rollover based on the lifetime.

If you are using keys as the security method, you must specify the lifetime for the keys and change the keys on a regular basis when they expire. To maintain stability, each party must be able to store and use more than one key for an application at the same time. A keychain is a sequence of keys that are collectively managed for authenticating the same peer, peer group, or both. Keychain groups a sequence of keys together under a keychain and associates each key in the keychain with a lifetime.

Principle Description

N/A

7.20.2 Configuration

step 1 Enter the configure mode

```
Switch# configure terminal
```

step 2 Create key chain and set key

```
Switch(config)# key chain test
Switch(config-keychain)# key 1
Switch(config-keychain-key)# key-string ##test_keysting_1##
Switch(config-keychain-key)# accept-lifetime 0:0:1 1 jan 2012 infinite
```

```
Switch(config-keychain)# key 2
Switch(config-keychain-key)# key-string ##test_keyststring_2##
Switch(config-keychain-key)# send-lifetime 0:0:1 2 jan 2012 infinite
```

step 3 Exit the configure mode

```
Switch(config)# end
```

step 4 Validation

To display the keychain configuration, use the command show key chain in the privileged EXEC mode“

```
Switch # show key chain
key chain test:
  key 1 -- text "key-string ##test_keyststring_1##"
    accept-lifetime <00:00:01 Jan 01 2012> - <infinite>
    send-lifetime <always valid> - <always valid> [valid now]
  key 2 -- text "key-string ##test_keyststring_2##"
    accept-lifetime <always valid> - <always valid> [valid now]
    send-lifetime <00:00:01 Jan 02 2012> - <infinite>
```

7.20.3 Application cases

N/A

7.21 Configuring Port-Block

7.21.1 Overview

Function Introduction

By default, the switch floods packets with unknown destination MAC addresses out of all ports. If unknown unicast and multicast traffic is forwarded to a protected port, there could be security issues. To prevent unknown unicast or multicast traffic from being forwarded from one port to another, you can block a port (protected or unprotected) from flooding unknown unicast or multicast packets to other ports.

Principle Description

N/A

7.21.2 Configuration

step 1 Enter the configure mode

```
Switch# configure terminal
```

step 2 Enter the interface configure mode and block unknown unicast

```
Switch(config)# interface eth-0-1
Switch(config-if)# port-block unknown-unicast
Switch(config-if)# exit
```

step 3 Exit the configure mode

```
Switch(config)# end
```

step 4 Validation

To display the port-block configuration, use the command `show port-block` in the privileged EXEC mode:

```
Switch # show port-block interface eth-0-1
Known unicast blocked: Enabled
Known multicast blocked: Disabled
Unknown unicast blocked: Disabled
Unknown multicast blocked: Disabled
Broadcast blocked: Disabled
```

7.21.3 Application cases

N/A

8 Device Management Configuration Guide

8.1 Configuring STM

8.1.1 Overview

Function Introduction

Switch Table Management (STM) is used to configure system resources in the switch to optimize support for specific features, depending on how the switch is used in the network.

You can select a profile to provide maximum system usage for some functions; for example, use the default profile to balance resources and use vlan profile to obtain max MAC entries.

To allocate ternary content addressable memory (TCAM) resources for different usages, the switch STM profile prioritize system resources to optimize support for certain features. You can select STM templates to optimize these features:

- layer2: The VLAN template supports the maximum number of unicast MAC addresses. It would typically be selected for a Layer 2 switch.
- layer3: The routing template maximizes system resources for unicast routing, typically required for a router or aggregator in the center of a network.
- ipv6: The ipv6 template, support the ipv6 functions.
- mpls: The mpls template supports the maximum number of MPLS/MAC entries.
- default: The default template gives balance to all functions.



When users configured a profile mode which is not exist in the next reboot image, then default hardware configure will be used when system up with the next image. The hardware configure may be different from the default profile.

Principle Description

N/A

8.1.2 Configuration

Follow these guidelines when selecting and configuring STM profiles.

You must reload the switch for the configuration to take effect.

Use the “stm prefer layer2” global configuration command only on switches intended for Layer 2 switching with no routing.

Do not use the layer3 profile if you do not have routing enabled on your switch. The stm prefer layer3 global configuration command prevents other features from using the memory allocated to IPv4 unicast routing in the routing profile.

step 1 Enter the configure mode

```
Switch# configure terminal
```

step 2 Set STM profile(use layer3 for example)

```
Switch(config)# stm prefer layer3
```

step 3 Exit the configure mode

```
Switch(config)# end
```

step 4 Validation

This is an example of an output display for route template:

```
Switch# show stm prefer
Current profile is :default
  number of vlan instance           : 1/4094
  number of unicast mac address     : 0/65536
  number of multicast mac address   : 0/2048
  number of blackhole mac address   : 0/128
  number of max applied vlan mapping : 0/1024
  number of bfd sessions            : 0/128
  number of CFM loacl&remote MEPs  : 0/1024
  number of CFM lm                  : 0/256
  number of CFM lck                 : 0/24
  number of G8031 groups            : 0/256
  number of G8032 rings             : 0/256
  number of G8032 member ports     : 0/256
```

```

number of mac based vlan class           : 0/512
number of ipv4 based vlan class          : 0/512
number of ipv6 based vlan class          : 0/0
number of dot1x mac based                : 0/2048
number of unicast ipv4 host routes       : 0/4096
number of unicast ipv4 indirect routes   : 0/8192
number of unicast ipv4 policy based routes : 0/16
number of unicast ipv6 host routes       : 0/0
number of unicast ipv6 indirect routes   : 0/0
number of unicast ecmp groups            : 0/240
number of unicast ip tunnel peers        : 0/8
number of multicast ipv4 routes          : 0/1023
number of mvr entries                    : 0/511
number of mvr6 entries                   : 0/0
number of multicast ipv6 routes          : 0/0
number of ipv4 source guard entries       : 0/1024
number of ingress port acl flow entries   : 0/2035
number of ingress vlan acl flow entries   : 0/255
number of egress port acl flow entries    : 0/255
number of ingress port qos flow entries   : 9/2043
number of ingress port acl ipv6 flow entries : 0/0
number of ingress vlan acl ipv6 flow entries : 0/0
number of egress port acl ipv6 flow entries : 0/0
number of ingress port qos ipv6 flow entries : 0/0
number of link aggregation (static & lacp) : 0/55
number of ipfix cache                    : 0/16384

```

The profile stored for use after the next reload is the layer3 profile.

step 5 Reboot the device

```
Switch# reload
```

8.1.3 Application cases

N/A

8.2 Configuring syslog

8.2.1 Overview

Function Introduction

The system message logging software can save messages in a log file or direct the messages to other devices. The system message logging facility has these features:

- Provides you with logging information for monitoring and troubleshooting.

- Allows you to select the types of logging information that is captured.
- Allows you to select the destination of the captured logging information.

By default, the switch logs normal but significant system messages to its internal buffer and sends these messages to the system console. You can specify which system messages should be saved based on the type of the severity level. The messages are time-stamped to enhance real-time debugging and management.

You can access the logged system messages using the switch command-line interface (CLI) or by saving them to a properly configured log server. The switch software saves the log messages in an internal buffer that can store up to 1000 messages. You can monitor the system messages remotely by accessing the switch through Telnet or the console port, or by viewing the logs on a log server.

Principle Description

Terminology:

Terminology	Description
Logging	Current logging configuration
Show	Show logging configuration
Levels	Severity level information
Enable	Enable write log to local file
Disable	Disable write log to local file

System Message Log Facility Types:

Facility Name	Definition
kern	kernel messages
user	random user-level messages
mail	mail system
daemon	system daemons
auth	security/authorization messages

syslog	messages generated internally by syslogd
lpr	line printer subsystem
news	network news subsystem
uucp	UUCP subsystem
cron	clock daemon
authpriv	security/authorization messages (private)
ftp	ftp daemon

Severity Level Definitions:

Severity Level	Definition
emergency	system is unusable
alert	action must be taken immediately
critical	critical conditions
error	error conditions
warning	warning conditions
notice	normal but significant condition
information	Informational
debug	debug-level messages

8.2.2 Configuration

Configuring Logging server

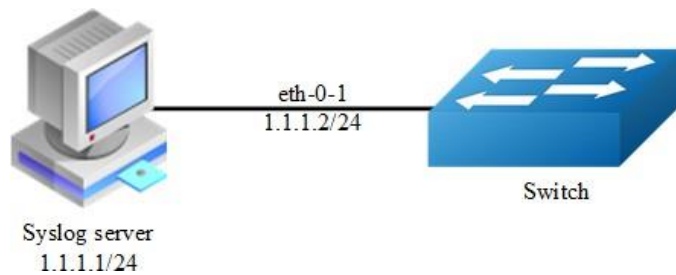

Figure 8-1 syslog server

step 1 Enter the configure mode

```
Switch# configure terminal
```

step 2 Enable logging server and set the attributes

```
Switch(config)# logging server enable
Switch(config)# logging server address 1.1.1.1
Switch(config)# logging server address 2001:1000::2
Switch(config)# logging server severity debug
Switch(config)# logging server facility mail
```

step 3 Exit the configure mode

```
Switch(config)# end
```

step 4 Validation

```
Switch# show logging
Current logging configuration:
=====
logging buffer 500
logging timestamp bsd
logging file enable
logging level file warning
logging level module debug
logging server enable
logging server severity debug
logging server facility mail
logging server address 1.1.1.1
logging server address 2001:1000::2
logging alarm-trap enable
logging alarm-trap level middle
```

```
logging merge enable
logging merge fifo-size 1024
logging merge timeout 10
logging operate disable
```

Configuring Logging Buffer Size

By default, the number of messages to log to the logging buffer is 500. If desired, you can set the number between 10 and 1000.

step 1 Enter the configure mode

```
Switch# configure terminal
```

step 2 Set the logging Buffer Size

```
Switch(config)# logging buffer 700
```

step 3 Exit the configure mode

```
Switch(config)# end
```

step 4 Validation

```
Switch# show logging
Current logging configuration:
=====
logging buffer 700
logging timestamp bsd
logging file enable
logging level file warning
logging level module debug
logging server enable
logging server severity debug
logging server facility mail
logging server address 1.1.1.1
logging alarm-trap enable
logging alarm-trap level middle
logging merge enable
logging merge fifo-size 1024
logging merge timeout 10
logging operate disable
```

The following is the information of logging server:

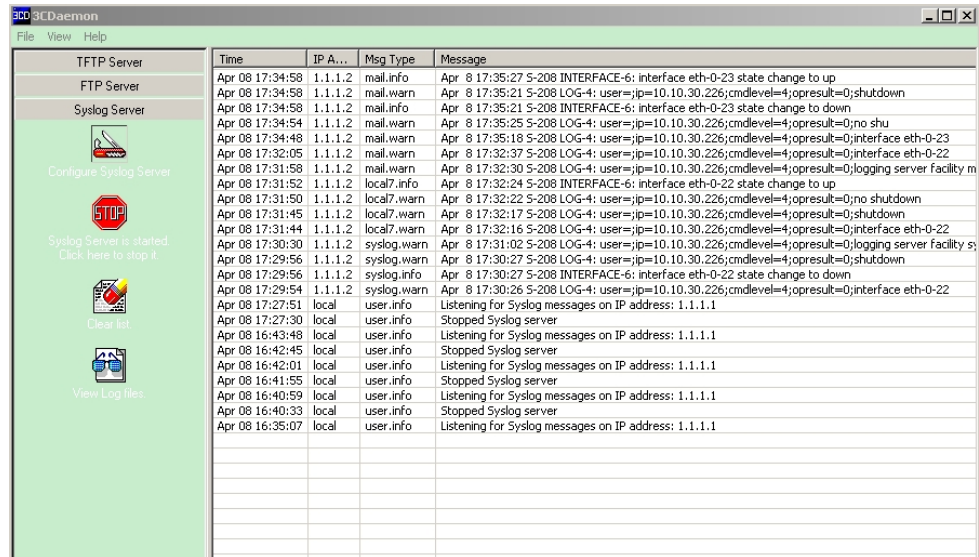

Time	IP A...	Msg Type	Message
Apr 08 17:34:58	1.1.1.2	mail.info	Apr 8 17:35:27 5-208 INTERFACE-6: interface eth-0-23 state change to up
Apr 08 17:34:58	1.1.1.2	mail.warn	Apr 8 17:35:21 5-208 LOG-4: user=jpg=10.10.30.226;cmdlevel=4;opresult=0;shutdown
Apr 08 17:34:58	1.1.1.2	mail.info	Apr 8 17:35:21 5-208 INTERFACE-6: interface eth-0-23 state change to down
Apr 08 17:34:54	1.1.1.2	mail.warn	Apr 8 17:35:25 5-208 LOG-4: user=jpg=10.10.30.226;cmdlevel=4;opresult=0;no shu
Apr 08 17:34:48	1.1.1.2	mail.warn	Apr 8 17:35:18 5-208 LOG-4: user=jpg=10.10.30.226;cmdlevel=4;opresult=0;interface eth-0-23
Apr 08 17:32:05	1.1.1.2	mail.warn	Apr 8 17:32:37 5-208 LOG-4: user=jpg=10.10.30.226;cmdlevel=4;opresult=0;interface eth-0-22
Apr 08 17:31:52	1.1.1.2	local7.info	Apr 8 17:32:30 5-208 LOG-4: user=jpg=10.10.30.226;cmdlevel=4;opresult=0;logging server facility m
Apr 08 17:31:50	1.1.1.2	local7.info	Apr 8 17:32:24 5-208 INTERFACE-6: interface eth-0-22 state change to up
Apr 08 17:31:50	1.1.1.2	local7.warn	Apr 8 17:32:22 5-208 LOG-4: user=jpg=10.10.30.226;cmdlevel=4;opresult=0;no shutdown
Apr 08 17:31:45	1.1.1.2	local7.warn	Apr 8 17:32:17 5-208 LOG-4: user=jpg=10.10.30.226;cmdlevel=4;opresult=0;shutdown
Apr 08 17:31:44	1.1.1.2	local7.warn	Apr 8 17:32:16 5-208 LOG-4: user=jpg=10.10.30.226;cmdlevel=4;opresult=0;interface eth-0-22
Apr 08 17:30:30	1.1.1.2	syslog.warn	Apr 8 17:31:02 5-208 LOG-4: user=jpg=10.10.30.226;cmdlevel=4;opresult=0;logging server facility s;
Apr 08 17:29:56	1.1.1.2	syslog.warn	Apr 8 17:30:27 5-208 LOG-4: user=jpg=10.10.30.226;cmdlevel=4;opresult=0;shutdown
Apr 08 17:29:56	1.1.1.2	syslog.info	Apr 8 17:30:27 5-208 INTERFACE-6: interface eth-0-22 state change to down
Apr 08 17:29:54	1.1.1.2	syslog.warn	Apr 8 17:30:26 5-208 LOG-4: user=jpg=10.10.30.226;cmdlevel=4;opresult=0;interface eth-0-22
Apr 08 17:27:51	local	user.info	Listening for Syslog messages on IP address: 1.1.1.1
Apr 08 17:27:30	local	user.info	Stopped Syslog server
Apr 08 16:43:48	local	user.info	Listening for Syslog messages on IP address: 1.1.1.1
Apr 08 16:42:45	local	user.info	Stopped Syslog server
Apr 08 16:42:01	local	user.info	Listening for Syslog messages on IP address: 1.1.1.1
Apr 08 16:41:55	local	user.info	Stopped Syslog server
Apr 08 16:40:59	local	user.info	Listening for Syslog messages on IP address: 1.1.1.1
Apr 08 16:40:33	local	user.info	Stopped Syslog server
Apr 08 16:35:07	local	user.info	Listening for Syslog messages on IP address: 1.1.1.1

Figure 8-2 syslog on server



NOTE

You can use command to check showing Logging Information. When configuring the syslog Servers, make sure the cables is linked correctly and two computers can ping each other. Before you can send the system log messages to a log server, you must configure Syslog Software, at the end you can see the log from your software.

8.2.3 Application cases

N/A

8.3 Configuring mirror

8.3.1 Overview

Function Introduction

Mirror function can send one or more copies of packets which are passing through the ports/vlans or sending and receiving by CPU to one or more specified destination ports. It can also send the copies to the CPU and keep in memory or flash files.

The copies of the packets are used for network analyze. The mirror function does not affect the original network traffic.

Principle Description

The following describes concepts and terminology associated with mirror configuration:

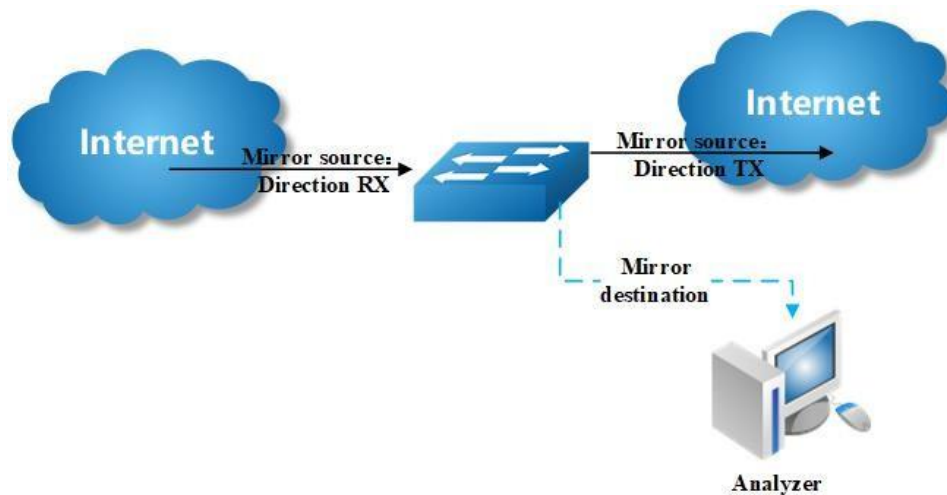

Figure 8-3 Mirror

1. Mirror session

A mirror session is an association of a mirror destination with one or more mirror source. The mirror destination and mirror source will describe later.

The device supports up to 3 mirror sessions.

Mirror sessions do not interfere with the normal operation of the switch. However, an oversubscribed mirror destination, for example, a 10-Gbps port monitoring a 100-Gbps port, results in dropped or lost packets.

2. Mirror direction

The device supports to set the direction of the mirror source, there are 3 options for choose: TX/RX/BOTH.

Receive (RX) mirror: The goal of receive (or ingress) mirror is to monitor as much as possible packets received by the source interface or VLAN before any modification or processing is performed by the switch. A copy of each packet received (except these packets: BPDU, LACPDU, BMGPDU, packets have been discarded by IP-MAC binding check for Vlan_based mirror, CRC error packets for both Port_based and vlan_based mirror) by the source is sent to the destination port for that mirror session.

You can monitor a series or range of ingress ports or VLANs in a mirror session. Packets that are modified because of routing are copied without modification; that is, the original packet is copied. Packets that are modified because of quality of service (QoS)—for example, modified Differentiated Services Code Point (DSCP)—are copied with modification. Packets that are modified because of VLAN translation or VLAN classification is copied with the modification. Some features that can cause a packet to be dropped during receive processing have no effect on mirror, the destination port can receive a copy of the packet even if the actual incoming packet is dropped. These features include ingress ACL, VLAN's ingress filter, MAC filter, STP, VLAN tag control, port security, unknown routing packets.

Transmit (TX) mirror: The goal of transmit (or egress) mirror is to monitor as much as possible packets sent by the source interface after all modification and processing is performed by the switch. A copy of each packet (except these packets: packets from CPU port for Vlan_based mirror, mirroring packets for both Port_based and vlan_based mirror) sent by the source is sent to the destination port for that mirror session. Some features that can cause a packet to be dropped during transmit processing might have affect on mirror.

Both: In a mirror session, you can monitor a single port for both received and sent packets.

3.Mirror source

The Mirror source is the original traffic of the network. The types of source are described as following:

Source port: A source port is a layer2 or layer 2 interface which need to be monitored. A physical port or link agg port can be a source port. The member of link agg port is not supported to be a mirror source.

Source VLAN: A source vlan is a vlan which need to be monitored. User should create a vlan interface before set a vlan as mirror source.

CPU:User can set CPU as mirror source to monitor the packets send to or receive from the CPU. The copies of packets send to the mirror destination are before cpu-traffic-limit process. Only session 1 support CPU as mirror source currently.

4. Mirror destination

Mirror function will copy the packets and sent the copies to the mirror destination.

The types of destination are described as following:

Local destination port: The destination port should be a physical port or link agg port, member of link agg port is not supported. The destination port has these characteristics:

- It must reside on the same switch as the source port.
- It should not be in "shutdown" state
- It can participate in only one mirror session at a time (a destination port in one mirror session cannot be a destination port for a second mirror session).
- It cannot be a source port.
- The port does not transmit any traffic except that required for the mirror session.
- It does not participate in spanning tree while the mirror session is active.
- When it is a destination port, all other normal system function of this port should not work until mirror destination configure disabled on this port.
- No address learning occurs on the destination port.
- The real statues of the speed/duplex might not coincide with the values which are displayed.

Multi-destination: The device supports to use a group of destination ports to receive several copies of the traffic. The characteristics of each member in the group of destination ports are same as single destination port.

Remote destination: A remote mirror destination is a remote destination vlan, which has a specified out-going port. The copies of the packets should send to the specified port and add the tag of the remote vlan. A remote destination has these characteristics:

- It is a vlan with a specified out going port.
- The remote VLAN range should be 2 to 4094. If the VLAN isn't created in system, user can not configure this VLAN as mirror remote vlan.
- The out going port should be a physical port. User should manually check if the out going port can transfer mirrored packets.

- Monitor traffic packets are inserted a tag with the remote VLAN ID and directed over the specified out going port to the mirror destination session device.
- It is recommended to configure remote mirror's destination port as switch port. Users should add the destination port to the remote vlan otherwise the mirrored packet can not be transmitted out.

CPU destination: send the copies of packet to the CPU of current device. If there is no analyzer available, user can use CPU as mirror destination and save the result for user or developers analyze packets.

You can analyze network traffic passing through ports or vlans by using mirror function to send a copy of the traffic to another port on the switch that has been connected to a Switch Probe device or other Remote Monitoring (RMON) probe or security device. However, when there is no other monitoring device for capturing packets, normal mirror destination to ports doesn't work. So we can set CPU as mirror destination to send a copy of the traffic to CPU for storing packets. It supports the cli to display the packets of mirror CPU and write the packets in a text file. It is a very functional debug tool. Mirror does not affect the switching of network traffic on source ports or source vlans; a copy of the packets received or sent by the source interfaces are sent to the destination CPU. The `cpu-traffic-limit rate` can be configured. CPU can participate as a destination in only one mirror session.

8.3.2 Configuration

Configuring Local port mirror

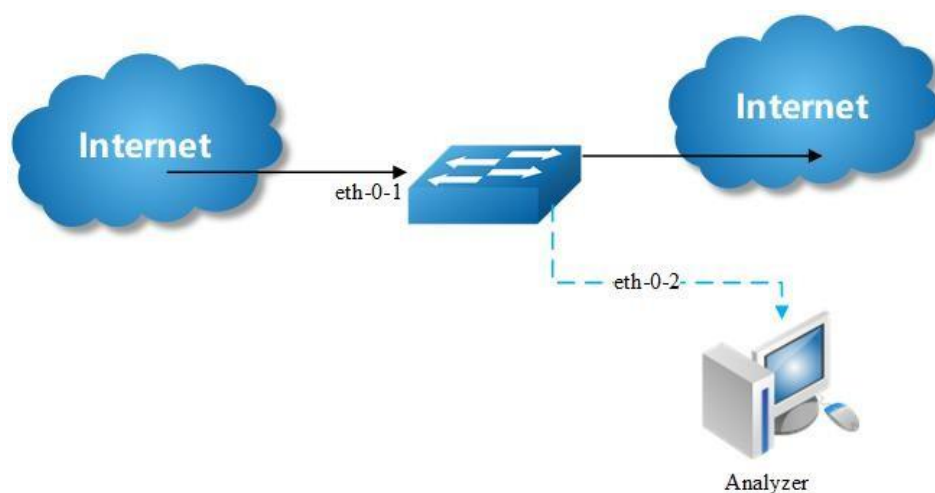

Figure 8-4 port Mirror

Copy the packets of eth-0-1 and send them to eth-0-2

step 1 Enter the configure mode

```
Switch# configure terminal
```

step 2 Set the destination of mirror

```
Switch(config)# interface eth-0-2
Switch(config-if)# no shutdown
Switch(config-if)# exit
Switch(config)# monitor session 1 destination interface eth-0-2
```

step 3 Set the source of mirror

```
Switch(config)# monitor session 1 source interface eth-0-1 both
```

step 4 Exit the configure mode

```
Switch(config)# end
```

step 5 Validation

```
Switch# show monitor session 1
Session 1
-----
Status           : Valid
Type             : Local Session
Source Ports     :
  Receive Only   :
  Transmit Only  :
  Both           : eth-0-1
Source VLANs     :
  Receive Only   :
  Transmit Only  :
  Both           :
Destination Port : eth-0-2
```

Configuring local vlan mirror

Copy the packets from vlan 10 and send them to eth-0-2

step 1 Enter the configure mode

```
Switch# configure terminal
```

step 2 Set the destination of mirror

```
Switch(config)# interface eth-0-2
Switch(config-if)# no shutdown
Switch(config-if)# exit
Switch(config)# monitor session 1 destination interface eth-0-2
```

step 3 Enter the vlan configure mode and create a vlan

```
Switch(config)# vlan database
Switch(config-vlan)# vlan 10
Switch(config-vlan)# exit
```

step 4 Create a vlan interface

```
Switch(config)# interface vlan10
Switch(config-if)# exit
```

step 5 Set the source of mirror

```
Switch(config)# monitor session 1 source vlan 10 rx
```

step 6 Exit the configure mode

```
Switch(config)# end
```

step 7 Validation

```
Switch# show monitor session 1
Session 1
-----
Status           : Valid
Type             : Local Session
Source Ports     :
  Receive Only   :
  Transmit Only  :
  Both           :
Source VLANs     :
  Receive Only   : 10
  Transmit Only  :
  Both           :
Destination Port : eth-0-2
```

Configuring CPU as mirror source

Copy the packets from or to CPU and send them to eth-0-2

step 1 Enter the configure mode

```
Switch# configure terminal
```

step 2 Set the destination of mirror

```
Switch(config)# interface eth-0-1
Switch(config-if)# no shutdown
Switch(config-if)# exit
Switch(config)# monitor session 1 destination interface eth-0-2
```

step 3 Set the source of mirror

```
Switch(config)# monitor session 1 source cpu both
```

step 4 Exit the configure mode

```
Switch(config)# end
```

step 5 Validation

```
DUT1# show monitor session 1
Session 1
-----
Status          : Valid
Type            : Cpu Session
Source Ports    :
  Receive Only  :
  Transmit Only :
  Both          : cpu
Source VLANs    :
  Receive Only  :
  Transmit Only :
  Both          :
Destination Port : eth-0-1
```

Configuring Multi-destination Mirror

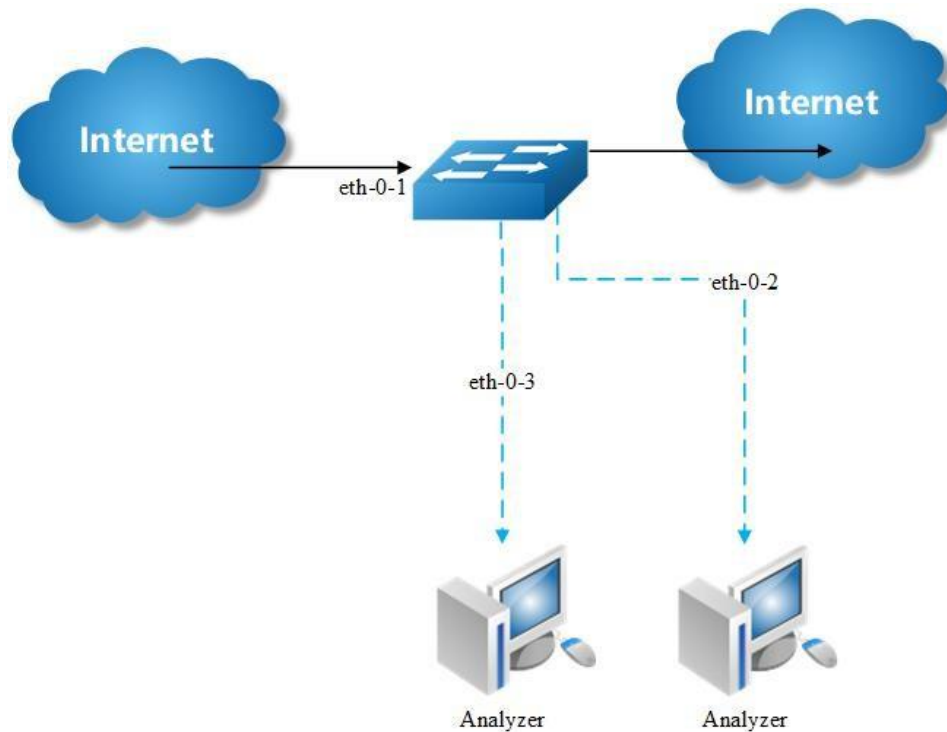

Figure 8-5 Multi-destination Mirror

Copy the packets of eth-0-1 and send them to eth-0-2 and eth-0-3

The rules of mirror source are same as single destination port. The following case use source port for example.

step 1 Enter the configure mode

```
Switch# configure terminal
```

step 2 Set the destination group of mirror

```
Switch(config)# interface eth-0-2
Switch(config-if)# no shutdown
Switch(config-if)# exit
Switch(config)# interface eth-0-3
Switch(config-if)# no shutdown
Switch(config-if)# exit
Switch(config)# monitor session 1 destination group 1
Switch(config-monitor-d-group)# member eth-0-2
Switch(config-monitor-d-group)# member eth-0-3
Switch(config-monitor-d-group)# exit
```

step 3 Set the source of mirror

```
Switch(config)# interface eth-0-1
Switch(config-if)# no shutdown
Switch(config-if)# exit
Switch(config)# monitor session 1 source interface eth-0-1
```

step 4 Exit the configure mode

```
Switch(config)# end
```

step 5 Validation

```
Session 1
-----
Status          : Valid
Type            : Local Session
Source Ports    :
  Receive Only  :
  Transmit Only :
  Both          : eth-0-1
Source VLANs    :
  Receive Only  :
  Transmit Only :
  Both          :
Destination Port : eth-0-2 eth-0-3
```

Configuring Remote Mirror

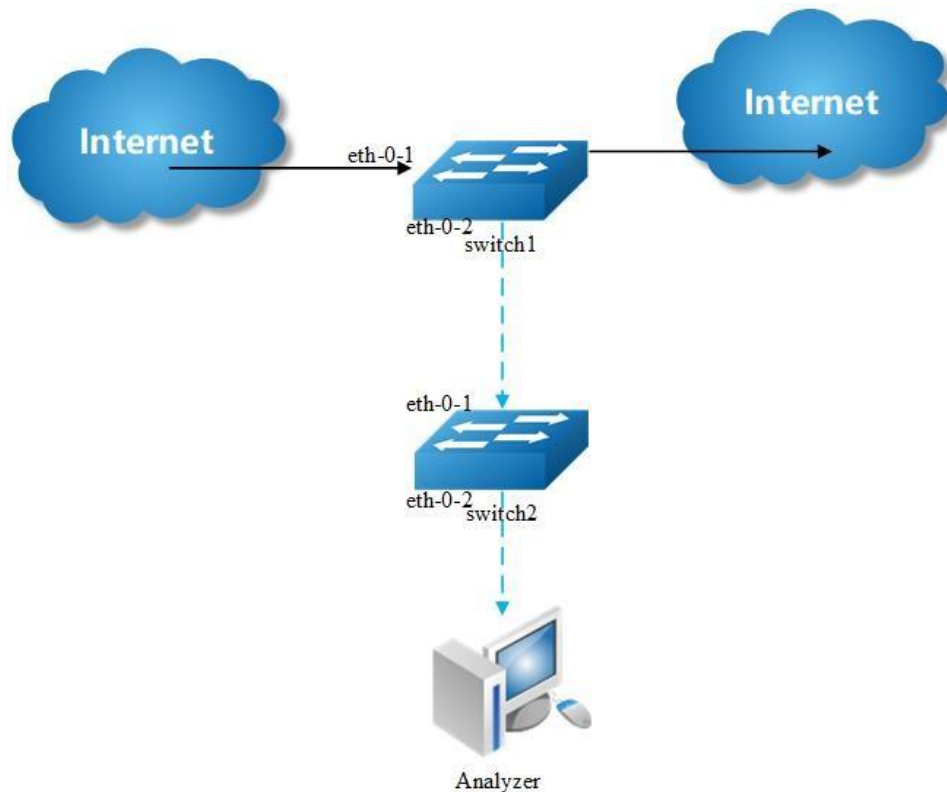

Figure 8-6 Remote Mirror

If local device cannot connect to an analyzer directly, User can choose remote mirror to send the copies of packets with specified vlan tag.

The remote device can pick out the packets with this vlan for analyze.

The following example copies the packets form Switch1's eth-0-1, and send them to Switch2 via Switch1's eth-0-2. Switch2 sends these packets to the analyzer.

The configuration of Switch1:

step 1 Enter the configure mode

```
Switch# configure terminal
```

step 2 Set the destination of mirror

```
Switch(config)# vlan database
Switch(config-vlan)# vlan 15
Switch(config-vlan)# exit
Switch(config-if)# exit
```

```
Switch(config)# interface eth-0-2
Switch(config-if)# no shutdown
Switch(config-if)# switchport mode trunk
Switch(config-if)# switchport trunk allowed vlan add 15
Switch(config-if)# exit

Switch(config)# monitor session 1 destination remote vlan 15 interface eth-0-2
```

step 3 Set the source of mirror

```
Switch(config)# interface eth-0-1
Switch(config-if)# no shutdown
Switch(config)# monitor session 1 source interface eth-0-1 both
```

step 4 Exit the configure mode

```
Switch(config)# end
```

step 5 Validation

```
SwitchA# show monitor session 1
Session 1
-----
Status          : Valid
Type            : Remote Session
Source Ports    :
  Receive Only  :
  Transmit Only :
  Both          : eth-0-1
Source VLANs    :
  Receive Only  :
  Transmit Only :
  Both         :
Destination Port : eth-0-2
Destination remote VLAN : 15
```

The configuration of Switch2:

Use these methods on Switch2 to send packets to analyzer via eth-0-2

method 1: use vlan 15 as mirror source , eth-0-2 as mirror destination

```
Switch # configure terminal
Switch (config)# vlan database
Switch (config-vlan)# vlan 15
Switch (config-vlan)# exit

Switch (config)# interface vlan15
Switch (config-if)# exit
```

```
Switch (config)# interface eth-0-2
Switch (config-if)# no shutdown

Switch (config)# interface eth-0-1
Switch (config-if)# no shutdown
Switch (config-if)# switchport mode trunk
Switch (config-if)# switchport trunk allowed vlan add 15
Switch (config-if)# exit

Switch (config)# monitor session 1 destination interface eth-0-2
Switch (config)# monitor session 1 source vlan 15 rx
Switch (config)# end
```

method 2: add both ports in to the same vlan (15), and make the packet flood in this vlan

```
Switch# configure terminal

Switch(config)# no spanning-tree enable

Switch(config)# vlan database
Switch(config-vlan)# vlan 15
Switch(config-vlan)# exit

Switch(config)# interface eth-0-2
Switch(config-if)# no shutdown
Switch(config-if)# switchport mode access
Switch(config-if)# switchport access vlan 15

Switch(config)# interface eth-0-1
Switch(config-if)# no shutdown
Switch(config-if)# switchport mode trunk
Switch(config-if)# switchport trunk allowed vlan add 15
Switch(config-if)# exit
```



NOTE In this configuration vlan tag is stripped because eth-0-2 is access port.

method 3: flood in vlan and keep vlan tag 15

If user needs to keep the vlan tag 15, eth-0-2 should be trunk port: (other configurations are same as method 2)

```
Switch(config)# interface eth-0-2
Switch(config-if)# no shutdown
Switch(config-if)# switchport mode trunk
Switch(config-if)# switchport trunk allowed vlan add 15
```

Configuring CPU Mirror Dest

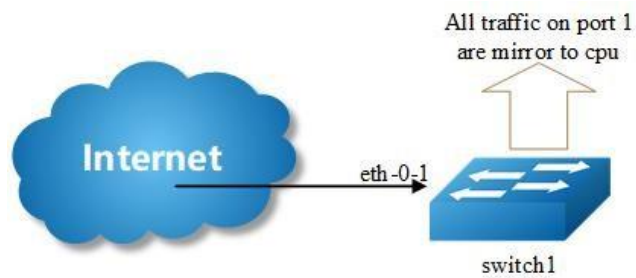

Figure 8-7 Mirror to cpu

step 1 Enter the configure mode

```
Switch# configure terminal
```

step 2 Set the destination of mirror

```
Switch(config)# monitor session 1 destination cpu
```

Set the buffer size and to cpu rate:

```
Switch(config)# monitor cpu set packet buffer 100
Switch(config)# cpu-traffic-limit reason mirror-to-cpu rate 128
```

step 3 Set the source of mirror

```
Switch(config)# monitor session 1 source interface eth-0-1 both
```

step 4 Exit the configure mode

```
Switch(config)# end
```

Optional steps

Enable or disable to write the packets in to the flash files.

```
Switch# monitor cpu capture packet start
Switch# monitor cpu capture packet stop
```

Exchange the files from *.txt to *.pcap

```
Switch# pcap convert flash:/mirror/MirCpuPkt-2016-02-05-18-31-13.txt
flash:/MirCpuPkt-2016-02-05.pcap
```

Set the action after the packet buffer is exceeded: "drop" means discard the latest packet; "replace" means discard the oldest packet.

```
Switch(config)# monitor cpu capture strategy drop
Switch(config)# monitor cpu capture strategy replace
```

step 5 Validation

This example shows how to set up a mirror session, session 1, for monitoring source port traffic to a destination cpu. You can use show monitor session to see the configuration.

```
Switch# show monitor session 1
DUT1# show monitor session 1
Session 1
-----
Status          : Valid
Type            : Cpu Session
Source Ports    :
  Receive Only  :
  Transmit Only :
  Both          : eth-0-1
Source VLANs    :
  Receive Only  :
  Transmit Only :
  Both          :
Destination Port : cpu
```

This example shows how to display the mirror cpu packets

```
Switch# show monitor cpu packet all
-----show all mirror to cpu packet info-----
packet: 1
Source port: eth-0-1
MACDA:264e.ad52.d800, MACSA:0000.0000.1111
vlan tag:100
IPv4 Packet, IP Protocol is 0
IPDA:3.3.3.3, IPSA: 10.0.0.2
Data length: 47
Data:
 264e ad52 d800 0000 0000 1111 8100 0064
 0800 4500 001d 0001 0000 4000 6ad9 0a00
 0002 0303 0303 6365 6e74 6563 796f 75
```

This example shows how to display the mirror buffer size:

```
Switch# show monitor cpu packet buffer
-----show packet buffer size -----
The mirror-to-cpu packet buffer size of user set is: 100
```

This example shows how to display the mirror cpu traffic-limit rate:

```
Switch# show cpu traffic-limit | include mirror-to-cpu
mirror-to-cpu          128          0
```

This example shows how to display the files of the flash:

```

Switch# ls flash:/mirror
Directory of flash:/mirror

total 8
-rw-r----- 1 2287 Dec 23 01:16 MirCpuPkt-2016-12-23-01-15-54.txt
-rw-r----- 1 2568 Jan  3 11:41 MirCpuPkt-2017-01-03-11-41-33.txt
14.8T bytes total (7.9T bytes free)

Switch# more flash:/mirror/ MirCpuPkt-2017-01-03-11-41-33.txt
sequence srcPort
1          eth-0-1
+++++++1483443444:648884
8c 1d cd 93 51 00 00 00 00 11 11 08 00 45 00
00 26 00 01 00 00 40 00 72 d0 01 01 01 03 03
03 03 63 65 6e 74 65 63 79 6f 75 63 65 6e 74 65
63 79 6f 75
-----
sequence srcPort
2          eth-0-1
+++++++1483443445:546440
8c 1d cd 93 51 00 00 00 00 11 11 08 00 45 00
00 26 00 01 00 00 40 00 72 d0 01 01 01 03 03
03 03 63 65 6e 74 65 63 79 6f 75 63 65 6e 74 65
63 79 6f 75

```

This example shows how to display the files of the flash. *.pcap files can open with packets analyzer applications such as wireshark. Please referenc to the "ftp" and "tftp" part to download the files.

```

Switch#ls flash:/mirror
Directory of flash:/mirror

total 12
-rw-r----- 1 2287 Dec 23 01:16 MirCpuPkt-2016-12-23-01-15-54.txt
-rw-r----- 1 2568 Jan  3 11:41 MirCpuPkt-2017-01-03-11-41-33.txt
-rw-r--r--  1  704 Jan  3 13:07 test.pcap
14.8T bytes total (7.9T bytes free)

```

This example shows how to display the actions after the buffer is full

```

Switch# show monitor cpu capture strategy
The capture strategy of cpu mirror is: replace (add new packet and remove oldest
packet when buffer is full)

```

8.3.3 Application cases

N/A

8.4 Configuring Device Management

8.4.1 Overview

Function Introduction

User can manage the switch through the management port. The switch has two management ports: an Ethernet port and a console port.

Principle Description

N/A

8.4.2 Configuration

Configuring console port for management

The default console parameters of switch are:

- Baud rate default is 115200.
- Data bits default is 8.
- Stop bits default is 1.
- Parity settings default is none.

Before you can assign switch information, make sure you have connected a PC or terminal to the console port, and configured the PC or terminal software parameters to match the default console port parameters. After login in the switch, you can modify the console parameters.

step 1 Enter the configure mode

```
Switch# configure terminal
```

step 2 Enter line configuration mode and set the console speed

```
Switch(config)# line console 0  
Switch(config-line)# speed 19200
```

step 3 Exit the configure mode

```
Switch(config-line)# end
```

step 4 Validation

After the above setting, console port parameter has been changed, and the PC or terminal can't configure the switch by console port. You must update PC or terminal console speed from 115200 to 19200 to match the new console parameter and can continue configure the switch by console port.

Configuring out band Ethernet port for management

In order to manage device by out band Ethernet port, you should configure management ip address first by console port.

step 1 Enter the configure mode

```
Switch# configure terminal
```

step 2 Configure switch management address

IPv4 & IPv6 are both supported, for example:

```
Switch(config)# management ip address 10.10.38.106/24  
Switch(config)# management ipv6 address 2001:1000::1/96
```

step 3 Exit the configure mode

```
Switch(config)# end
```

step 4 Validation

```
Switch# show management ip address  
Management IP address is: 10.10.38.106/24  
Gateway: 0.0.0.0  
  
Switch # show management ipv6 address  
Management IPv6 address is: 2001:1000::1/96  
Gateway: ::
```

Configuring Temperature

The switch supports temperature alarm management. You can configure three temperature thresholds: low, high and critical. When switch temperature is lower than low threshold or higher than higher threshold, the switch will be alarm. If the switch temperature is higher than critical threshold, the switch will cut off its power automatically.

step 1 Enter the configure mode

```
Switch# configure terminal
```

step 2 Configuring temperature threshold

5°C for low; 70°C for high; 90°C for critical.

```
Switch(config)# temperature 5 70 90
```

step 3 Exit the configure mode

```
Switch(config)# end
```

step 4 Validation

```
Switch# show environment
-----
Sensor status (Degree Centigrade):
Index Temperature Lower_alarm Upper_alarm Critical_limit
1      50           5           70           90
```

Configuring Fan

The switch supports to manage fan automatically. If the fan is fail or the fan tray is absent, the switch will be alarm. And if the fan tray supports speed-adjust, the switch can adjust the fan speed depending on the real-time temperature. The switch has three temperature thresholds: Tlow=50, Thigh=65 and Tcrit=80 Celsius scales. If Temperature=Temperature, the fan will run on 100% speed rate. And there has a temperature hysteresis Thyst=2 Celsius scales. Assuming temperature has previously crossed above Tlow, Thigh or Tcrit, then the temperature must drop below the points corresponding Thyst(Tlow-Thyst, Thigh-Thyst or Tcrit-Thyst) in order for the condition to drive fan speed rate to lower level. For example:

- temperature is 58 Celsius scales, the fan speed rate is 30%; (Tlow<58<Thigh)

- temperature increases to 65 Celsius scales, the fan speed rate is 70%;(Thigh=65)
- temperature decreases to 63 Celsius scales, the fan speed rate is still 70%;(Thigh-Thyst =63)
- temperature decreases to 62 Celsius scales, the fan speed rate is 30%;(62<Thigh-Thyst)

The Tlow, Thigh, Tcrit, Thyst and fan speed rate for each temperature threshold are hard code, and couldn't be modified.

```
Switch# show environment
Fan tray status:
Index      Status
1          PRESENT
FanIndex   Status  SpeedRate  Mode
1-1        OK      30%        Auto
1-2        OK      30%        Auto
1-3        OK      30%        Auto
1-4        OK      30%        Auto
-----
```

Configuring Power

The switch supports to manage power status automatically. If the power is failed or the fan in power is failed, the switch will be alarm. If power is removed or inserted, the switch will notice user also.

User can show the power status to verify the power status.

```
Switch# show environment
-----
Power status:
Index      Status   Power   Type      Fans      Control
1          PRESENT  OK      AC        -         -
2          ABSENT   -       -         -         -
3          PRESENT  OK      DC (PoE) -         -
-----
```

Configuring Transceiver

The switch supports manage the transceiver information, and the transceiver information includes basic information and diagnostic information. The basic information includes transceiver type, vendor name, PN, S/N, wavelength and link length for supported type. The diagnostic information includes real-time temperature, voltage, current, optical transmit power, optical receive power and

the threshold about these parameters. If the transceiver is inserted or removed, the real-time parameter is out of threshold, the switch will notice the users.

User can show the transceiver information to verify this function.

```
Switch# show transceiver detail
Port eth-1-2 transceiver info:
Transceiver Type: 10G Base-SR
Transceiver Vendor Name : OEM
Transceiver PN          : SFP-10GB-SR
Transceiver S/N         : 201033PST1077C
Transceiver Output Wavelength: 850 nm
Supported Link Type and Length:
    Link Length for 50/125um multi-mode fiber: 80 m
    Link Length for 62.5/125um multi-mode fiber: 30 m
-----
Transceiver is internally calibrated.
mA: milliamperes, dBm: decibels (milliwatts), NA or N/A: not applicable.
++ : high alarm, +  : high warning, -  : low warning, -- : low alarm.
The threshold values are calibrated.
-----
                High Alarm   High Warn   Low Warn   Low Alarm
Temperature   Threshold   Threshold   Threshold   Threshold
Port (Celsius) (Celsius)   (Celsius)   (Celsius)   (Celsius)
-----
eth-1-2  25.92    95.00      90.00      -20.00      -25.00
-----
                High Alarm   High Warn   Low Warn   Low Alarm
Voltage       Threshold   Threshold   Threshold   Threshold
Port (Volts)  (Volts)   (Volts)   (Volts)   (Volts)
-----
eth-1-2  3.32      3.80      3.70      2.90      2.80
-----
                High Alarm   High Warn   Low Warn   Low Alarm
Current       Threshold   Threshold   Threshold   Threshold
Port (milliamperes) (mA)      (mA)      (mA)      (mA)
-----
eth-1-2  6.41      20.00     18.00     1.00      0.50
-----
                High Alarm   High Warn   Low Warn   Low Alarm
Optical       Threshold   Threshold   Threshold   Threshold
Transmit Power (dBm)   (dBm)   (dBm)   (dBm)   (dBm)
Port (dBm)
-----
eth-1-2  -2.41     2.01      1.00      -6.99     -7.96
-----
                High Alarm   High Warn   Low Warn   Low Alarm
Optical       Threshold   Threshold   Threshold   Threshold
Receive Power (dBm)   (dBm)   (dBm)   (dBm)   (dBm)
Port (dBm)
```



```
-----  
-----  
eth-1-2      -12      -      1.00      0.00      -19.00      -20.00  
-----  
-----
```

Upgrade bootrom

The switch supports to upgrade the bootrom image when system is running. And after upgrading, you must reboot the switch to take effect.

step 1 Copy bootrom image file to the flash

```
Switch# copy mgmt-if tftp://10.10.38.160/bootrom.bin flash:/boot/
```

step 2 Enter the configure mode

```
Switch# configure terminal
```

step 3 Upgrade the bootrom

```
Switch(config)# update bootrom flash:/boot/bootrom.bin
```

step 4 Exit the configure mode

```
Switch(config)# end
```

step 5 Reboot the system

```
Switch# reboot
```

step 6 Validation

After the above setting, you can show uboot version information of platform:

```
Switch# show version  
.....  
EPLD Version is 1  
BootRom Version is 3.0.2
```

Upgrade EPLD

The switch supports to upgrade the EPLD image when system is running. And after upgrading, you must reboot the switch to take effect.

step 1 Copy epld image file to the flash

```
Switch# copy mgmt-if tftp://10.10.38.160/vme_v1.0 flash:/boot/vme_v1.0
```

step 2 Enter the configure mode

```
Switch# configure terminal
```

step 3 Upgrade the epld

```
Switch(config)# update epld flash:/boot/vme_v1.0
```

step 4 Exit the configure mode

```
Switch(config)# exit
```

step 5 Reboot the system

```
Switch# reboot
```

step 6 Validation

After the above setting, then power off and restart the device, you can show epld version information with command:

```
Switch# show version
.....
EPLD Version is 1
BootRom Version is 3.0.2
```

8.4.3 Application cases

N/A

8.5 Configuring Bootrom

8.5.1 Overview

Function Introduction

The main function of Bootrom is to initialize the board simply and load the system image to boot. You can use some necessary commands in bootrom mode.

Bootrom can load the system image both from TFTP server and persistent storage like flash. Then you can configure the Switch and TFTP server IP address as environment variables in Bootrom mode for boot the system image.

Principle Description

N/A

8.5.2 Configuration

Configuring Boot from TFTP Server

Method 1: Boot the system from TFTP server

Save the configuration and reboot the system:

```
bootrom:> setenv bootcmd boot_tftp OS-ms-v3.1.9.it.r.bin
bootrom:> saveenv
bootrom:> reset
```

Method 2: Method 1:Boot the system from TFTP server without password

Save the configuration and reboot the system:

```
bootrom:> setenv bootcmd boot_tftp_nopass OS-ms-v3.1.9.it.r.bin
bootrom:> saveenv
bootrom:> reset
```

Method 3: Boot the system from TFTP server and reboot automatically

```
bootrom:> boot_tftp OS-ms-v3.1.9.it.r.bin
```

Method 4: Boot the system from TFTP server and reboot automatically without password

```
bootrom:> boot_tftp_nopass OS-ms-v3.1.9.it.r.bin
```

Validation

After the above setting, you can get show information:

```
bootrom:> reset
.....
TFTP from server 10.10.29.160; our IP address is 10.10.29.118
```

```

Filename 'OS-ms-v3.1.9.it.r.bin'.
Load address: 0xaa00000
Loading: octeth0: Up 100 Mbps Full duplex (port 0)
#####
#####
done
Bytes transferred = 12314539 (bbe7ab hex), 1829 Kbytes/sec

```

Configuring Boot from FLASH

Boot the system from FLASH

Save the configuration and reboot the system:

```

bootrom:> setenv bootcmd boot_flash OS-ms-v3.1.9.it.r.bin
bootrom:> saveenv
bootrom:> reset

```

Boot the system from without password

Save the configuration and reboot the system:

```

bootrom:> setenv bootcmd boot_flash_nopass OS-ms-v3.1.9.it.r.bin
bootrom:> saveenv
bootrom:> reset
Do you want to revert to the default config file ? [Y|N|E]:Y

```

Boot the system from FLASH and reboot automatically

```

bootrom:> boot_flash OS-ms-v3.1.9.it.r.bin

```

Boot the system from FLASH and reboot automatically without password

```

bootrom:> boot_flash_nopass OS-ms-v3.1.9.it.r.bin
Do you want to revert to the default config file ? [Y|N|E]:Y

```

Validation

After the above setting, you can get show information:

```

bootrom:> reset
.....
Do you want to revert to the default config file ? [Y|N|E]:Y
### JFFS2 loading '/boot/OS-ms-v3.1.9.it.r.bin' to 0xaa00000
Scanning JFFS2 FS: . done.
### JFFS2 load complete: 12314539 bytes loaded to 0xaa00000
## Booting image at 0aa00000 ...
Verifying Checksum ... OK

```

```
Uncompressing Kernel Image ... OK
.....
```

Set boot IP

step 1 Set Switch IP address , details information as follows

```
bootrom:> setenv ipaddr 10.10.29.101
bootrom:> saveenv
```

step 2 Set TFTP server IP address , details information as follows

```
bootrom:> setenv serverip 10.10.29.160
bootrom:> saveenv
```

step 3 validation

After the above setting, you can get show information:

```
bootrom:> printenv
printenv
bootdelay=5
baudrate=9600
download_baudrate=9600
.....
stderr=serial
ipaddr=10.10.29.101
serverip=10.10.29.160
Environment size: 856/2044 bytes
```

Upgrade bootrom

step 1 upgrade the Bootrom image from TFTP server

```
bootrom:> upgrade_uboot bootrom.bin
```

step 2 validation

After the above setting, you can get show information:

```
bootrom:> version
version
Bootrom 3.0.3 (Development build) (Build time: Aug 4 2011 - 11:47:06)
```

Set gateway IP

step 1 Set Switch gateway IP address , details information as follows

```
bootrom:> setenv gatewayip 10.10.37.1
bootrom:> saveenv
```

step 2 Set network mask , details information as follows

```
bootrom:> setenv netmask 255.255.255.0
bootrom:> saveenv
```

step 3 validation

After the above setting, you can get show information:

```
bootrom:> printenv
printenv
bootdelay=5
baudrate=9600
download_baudrate=9600
.....
stderr=serial
gatewayip=10.10.38.1
netmask=255.255.255.0
Environment size: 856/2044 bytes
```

8.5.3 Application cases

N/A

8.6 Configuring SmartConfig

8.6.1 Overview

Function Introduction

SmartConfig is a smart method of switch initial configuration. After enabling SmartConfig, switch will start to download configuration file or image file from tftp server , if not finding startup-config file at startup. Then switch will install these file , and it will reboot itself if had downloaded image file.

Note that we use deploy file to control the configuration file and image file downloaded by switch. Switch fetch these file according the deploy file, which is a XML-formatted file. The deploy file named smartdeploy.xml , while its content like below:

```
<SmartDeploy>
<ftype>init</ftype>
<hostprefix>Bruce</hostprefix>
<defItem>
<option>enable</option>
<image>def.bin</image>
<config>def.cfg</config>
</defItem>
<groups>
<Item>
<type>MAC</type>
<value>001e.0808.9100</value>
<image>switch0s.bin</image>
<config>startup.cfg</config>
</Item>
<Item>
<type>productid</type>
<value>09SWITCH-E48-10</value>
<image>productid.bin</image>
<config>productid.cfg</config>
</Item>
<Item>
<type>SN</type>
<value>E054GD116004</value>
<image>sn.bin</image>
<config>sn.cfg</config>
</Item>
</groups>
</SmartDeploy>
```

There are three kind of item used by switch to find out image file and configuration file fit itself. Switch will search fit item according sequence like MAC, SN , product-id. We just specify the file name in the deploy file, and place all these file on tftp server.

Principle Description

N/A

8.6.2 Configuration

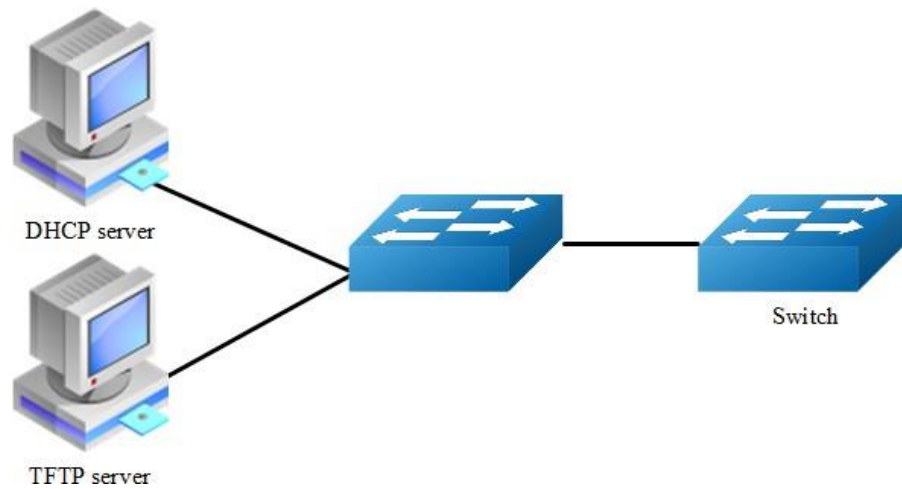

Figure 8-8 smart config

This figure is the network topology of testing SmartConfig function. We need two switches and two Linux boxes to construct the test bed. "switch" in the figure is the switch we enable SmartConfig on. Note that the address of the TFTP server provided by the DHCP server can be used by the switch to connect to the TFTP server directly or via routes.

Enable smartConfig

step 1 Enter the configure mode

```
Switch#configure terminal
```

step 2 Enable smartConfig

```
Switch(config)#smart-config initial-switch-deployment
```

step 3 Exit the configure mode

```
Switch (config)#exit
```

step 4 Validation

Use this command to check the smart-config settings:

```
Switch# show smart-config config
Smart-Config config:
  initial-switch-deployment: on
```



```
hostname-prefix: on
Send log message to console: on
```

Using smartConfig

SmartConfig was enable default, so we just make sure there is no startup-config.conf file. Then switch will start SmartConfig next boot. And we can delete startup-config.conf manually, so that Smartconfig will work after reboot. Procedure of configure SmartConfig as fallow:

step 1:

Configure smartdeploy.xml file, and place it with image file, configuration file to tftp server. The directory must be like this (Configuration files should be in conf directory and images should be in images directory.) :

```
smartconfig/
|--conf/
|--images/
|--smartdeploy.xml
```

step 2:

Configure DHCP server, tftp server address option must be set;

step 3:

Make sure there is no startup-config.conf file;

step 4:

boot or reboot the system.

8.6.3 Application cases

N/A

8.7 Reboot Logs

8.7.1 Overview

Function Introduction

Switch support display reboot logs. Depend on these logs, user can judge the reboot reasons of a switch. The reboot reasons include Manual Reboot, Power Off or Other Reasons.



User can find no more than 50 reboot logs through this command.

Detail about the show result as following:

Reboot Type	Description
POWER	Power outages
MANUAL	Cli “reboot/reload” is used
HIGH-TMPR	Reboot for abnormal high temperature
BHMDOG BHM	watchdog, monitor functional module
LCMDOG LCM	watchdog, monitor each LC
SCHEDULE	Schedule reboot
SNMP-RELOAD	SNMP reboot
HALFAIL	Reboot for HAGT communicate with HSRV failed, need stack enable
ABNORMAL	Unusual reboot, include reboot under shell
CTCINTR	Button reboot
LCATTACH	Reboot for LC attach CHSM failed
OTHER	Other reboot

Principle Description

N/A

8.7.2 Configuration

Reboot logs are enabled by default. User can display the logs as the following examples:

step 1 Display the logs

```
Switch# show reboot-info
Times      Reboot Type      Reboot Time (UTC)
-----+-----+-----
1          MANUAL          2023-01-04 20:54:22
2          MANUAL          2023-01-04 21:00:30
3          MANUAL          2023-01-04 21:06:53
4          MANUAL          2023-01-04 21:10:13
5          MANUAL          2023-01-04 21:14:16
6          MANUAL          2023-01-04 21:20:50
```

8.7.3 Application cases

N/A

9 Network Management Configuration Guide

9.1 Configuring Network Diagnosis

9.1.1 Overview

Function Introduction

Ping is a computer network administration utility used to test the reachability of a host on an Internet Protocol (IP) network and to measure the round-trip time for messages sent from the originating host to a destination computer. The name comes from active sonar terminology.

Ping operates by sending Internet Control Message Protocol (ICMP) echo request packets to the target host and waiting for an ICMP response. In the process it measures the time from transmission to reception (round-trip time) [1] and records any packet loss. The results of the test are printed in form of a statistical summary of the response packets received, including the minimum, maximum, and the mean round-trip times, and sometimes the standard deviation of the mean.

Traceroute is a computer network tool for measuring the route path and transit times of packets across an Internet Protocol (IP) network.

Traceroute sends a sequence of Internet Control Message Protocol (ICMP) packets addressed to a destination host. Tracing the intermediate routers traversed involves control of the time-to-live (TTL) Internet Protocol parameter. Routers decrement this parameter and discard a packet when the TTL value has reached zero, returning an ICMP error message (ICMP Time Exceeded) to the sender.

Principle Description

N/A

9.1.2 Configuration

Ping IP with in-band port

```
Switch# ping 10.10.29.247
Switch# ping ipv6 2001:1000::1
```

Ping IP with management port

```
Switch# ping mgmt-if 10.10.29.247
Switch# ping mgmt-if ipv6 2001:1000::1
```

Ping IP with VRF instance

```
Switch# ping vrf vrf1 10.10.10.1
```

Traceroute IP with inner port

```
Switch# traceroute 1.1.1.2
Switch# traceroute ipv6 2001:1000::1
```

9.1.3 Application cases

Example for Ping

```
Switch # ping mgmt-if 192.168.100.101
PING 192.168.100.101 (192.168.100.101) 56(84) bytes of data.
64 bytes from 192.168.100.101: icmp_seq=0 ttl=64 time=0.092 ms
64 bytes from 192.168.100.101: icmp_seq=1 ttl=64 time=0.081 ms
64 bytes from 192.168.100.101: icmp_seq=2 ttl=64 time=0.693 ms
64 bytes from 192.168.100.101: icmp_seq=3 ttl=64 time=0.071 ms
64 bytes from 192.168.100.101: icmp_seq=4 ttl=64 time=1.10 ms
--- 192.168.100.101 ping statistics ---
5 packets transmitted, 5 received, 0% packet loss, time 4054ms
rtt min/avg/max/mdev = 0.071/0.408/1.104/0.421 ms, pipe 2
```

Example for traceroute

```
Switch# traceroute 1.1.1.2
traceroute to 1.1.1.2 (1.1.1.2), 30 hops max, 38 byte packets
 1 1.1.1.2 (1.1.1.2) 112.465 ms 102.257 ms 131.948 ms
Switch # ping mgmt-if ipv6 2001:1000::1
PING 2001:1000::1(2001:1000::1) 56 data bytes
64 bytes from 2001:1000::1: icmp_seq=1 ttl=64 time=0.291 ms
64 bytes from 2001:1000::1: icmp_seq=2 ttl=64 time=0.262 ms
64 bytes from 2001:1000::1: icmp_seq=3 ttl=64 time=0.264 ms
64 bytes from 2001:1000::1: icmp_seq=4 ttl=64 time=0.270 ms
64 bytes from 2001:1000::1: icmp_seq=5 ttl=64 time=0.274 ms
--- 2001:1000::1 ping statistics ---
```

```
5 packets transmitted, 5 received, 0% packet loss, time 3997ms
rtt min/avg/max/mdev = 0.262/0.272/0.291/0.014 ms
```

9.2 Configuring NTP

9.2.1 Overview

Function Introduction

NTP is a tiered time distribution system with redundancy capability. NTP measures delays within the network and within the algorithms on the machine on which it is running. Using these tools and techniques, it is able to synchronize clocks to within milliseconds of each other when connected on a Local Area Network and within hundreds of milliseconds of each other when connected to a Wide Area Network. The tiered nature of the NTP time distribution tree enables a user to choose the accuracy needed by selecting a level (stratum) within the tree for machine placement. A time server placed higher in the tree (lower stratum number), provides a higher likelihood of agreement with the UTC time standard.

Some of the hosts act as time servers, that is, they provide what they believe is the correct time to other hosts. Other hosts act as clients, that is, they find out what time it is by querying a time server. Some hosts act as both clients and time servers, because these hosts are links in a chain over which the correct time is forwarded from one host to the next. As part of this chain, a host acts first as a client to get the correct time from another host that is a time server. It then turns around and functions as a time server when other hosts, acting as clients, send requests to it for the correct time.

Principle Description

N/A

9.2.2 Configuration

Configuring Client/Server mode connecting with in-band interface

Before configuring NTP client, make sure that NTP service is enabled on Server.

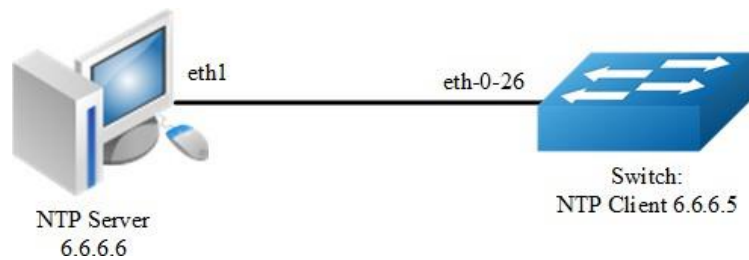

Figure 9-1 NTP

step 1 Enter the configure mode

```
Switch#configure terminal
```

step 2 Enter the vlan configure mode and create a vlan

```
Switch(config)# vlan database
Switch(config-vlan)# vlan 10
Switch(config-vlan)# exit
```

step 3 Enter the interface configure mode and join the vlan

```
Switch(config)# interface eth-0-26
Switch(config-if)# switch access vlan 10
Switch(config-if)# no shutdown
Switch(config-if)# exit
```

step 4 create a vlan interface and set the IP address

```
Switch(config)# interface vlan10
Switch(config-if)# ip address 6.6.6.5/24
Switch(config-if)# exit
```

step 5 Set the attributes of NTP client

Enable a trustedkey; Configure the IP address of the NTP server; Enable authentication; Once you have enabled authentication, the client switch sends the time-of-day requests to the trusted NTP servers only; Configure ntp ace.

```
Switch(config)# ntp key 1 serverkey
Switch(config)# ntp server 6.6.6.6 key 1
Switch(config)# ntp authentication enable
Switch(config)# ntp trustedkey 1
Switch(config)# ntp ace 6.6.6.6 none
```

step 6 Exit the configure mode

```
Switch(config)# end
```

step 7 Validation

```
Switch# show ntp
Current NTP configuration:
=====
NTP access control list:
  6.6.6.6 mask 255.255.255.255 none
Unicast peer:
Unicast server:
  6.6.6.6 key 1
Authentication: enabled
Local reference clock:
Disable management interface

Switch# show ntp status
Current NTP status:
=====
clock is synchronized
stratum:          7
reference clock:  6.6.6.6
frequency:        17.365 ppm
precision:        2**20
reference time:   d14797dd.70b196a2 ( 1:54:37.440 UTC   Thu Apr  7 2011)
root delay:       0.787 ms
root dispersion:  23.993 ms
peer dispersion:  57.717 ms
clock offset:     -0.231 ms
stability:        6.222 ppm
Switch# show ntp associations
Current NTP associations:
  remote          refid      st   when poll reach  delay  offset  disp
=====
*6.6.6.6          127.127.1.0   6    50  128   37    0.778  -0.234  71.945
synchronized, + candidate, # selected, x falsetick, . excess, - outlier
```

Configuring Client/Server mode connecting with management interface**step 1 Enter the configure mode**

```
Switch# configure terminal
```

step 2 Enable ntp management interface

```
Switch(config)# ntp mgmt-if only
```

Note1: Use the following command to enable both in-band and management interface

```
Switch(config)# ntp mgmt-if enable
```

Note: Use the following command to disable management interface

```
Switch(config)# no ntp mgmt-if
```

step 3 Set the attributes of NTP client

```
Switch(config)# ntp key 1 serverkey
Switch(config)# ntp server 192.168.100.101 key 1
Switch(config)# ntp authentication enable
Switch(config)# ntp trustedkey 1
Switch(config)# ntp ace 192.168.100.101 none
```

step 4 Exit the configure mode

```
Switch(config)# end
```

step 5 Validation

```
Switch# show ntp
Current NTP configuration:
=====
NTP access control list:
  192.168.100.101 mask 255.255.255.255 none
Unicast peer:
Unicast server:
  192.168.100.101 key 1
Authentication: enabled
Local reference clock:
Only management interface
Switch# show ntp associations
Current NTP associations:
remote          refid          st when poll reach  delay  offset  disp
=====
*192.168.100.101 127.127.1.0    3   27   64   1    1.328  2.033 433.075
* sys.peer, + candidate, # selected, x falsetick, . excess, - outlyer
```

9.2.3 Application cases

Configuring NTP Server (Use the ntpd of linux system for example)

Step 1 Display eth1 ip address

```
[root@localhost octeon]# ifconfig eth1
eth1      Link encap:Ethernet  HWaddr 00:08:C7:89:4B:AA
          inet addr:6.6.6.6  Bcast:6.6.6.255  Mask:255.255.255.0
          inet6 addr: fe80::208:c7ff:fe89:4baa/64 Scope:Link
          UP BROADCAST RUNNING MULTICAST  MTU:1500  Metric:1
          RX packets:3453 errors:1 dropped:0 overruns:0 frame:1
          TX packets:3459 errors:0 dropped:0 overruns:0 carrier:0
          collisions:0 txqueuelen:1000
          RX bytes:368070 (359.4 KiB)  TX bytes:318042 (310.5 KiB)
```

Step 2 Check networks via Ping

```
[root@localhost octeon]# ping 6.6.6.5
PING 6.6.6.5 (6.6.6.5) 56(84) bytes of data.
64 bytes from 6.6.6.5: icmp_seq=0 ttl=64 time=0.951 ms
64 bytes from 6.6.6.5: icmp_seq=1 ttl=64 time=0.811 ms
64 bytes from 6.6.6.5: icmp_seq=2 ttl=64 time=0.790 ms
```

Step 3 Configure ntp.conf

```
[root@localhost octeon]# vi /etc/ntp.conf
server 127.127.1.0 # local clock
fudge 127.127.1.0 stratum 5
#
# Drift file. Put this in a directory which the daemon can write to.
# No symbolic links allowed, either, since the daemon updates the file
# by creating a temporary in the same directory and then rename()'ing
# it to the file.
#
driftfile /var/lib/ntp/drift
broadcastdelay 0.008
broadcast 6.6.6.255
#
# PLEASE DO NOT USE THE DEFAULT VALUES HERE. Pick your own, or remote
# systems might be able to reset your clock at will. Note also that
# ntpd is started with a -A flag, disabling authentication, that
# will have to be removed as well.
#
#disable auth
keys /etc/ntp/keys
trustedkey 1
```

Step 4 Configure keys

```
[root@localhost octeon]# vi /etc/ntp/keys
#
# PLEASE DO NOT USE THE DEFAULT VALUES HERE. Pick your own, or remote
# systems might be able to reset your clock at will. Note also that
# ntpd is started with a -A flag, disabling authentication, that
# will have to be removed as well.
#
1 M serverkey
```

Step 5 Start ntpd service

```
[root@localhost octeon]# ntpd
```

9.3 Configuring Phy Loopback

9.3.1 Overview

Function Introduction

Phy loopback is a proprietary based loopback. There are 2 types of phy loopback: phy(including internal and external) level loopback and port level loopback.

- If a physical port is configured as “external phy loopback”, all packets coming into this port should be loopback back from the port itself at phy level.
- If a physical port is configured as “internal phy loopback”, all packets expected out from this port should be looped back to specified physical port.
- If a physical port is configured as “port loopback”, all packets coming into this port should be looped back from the port itself, and whether to swap the SMAC with the DMAC should be selectable by users. And if the MAC is swapped, the CRC should be recalculated.

Principle Description

N/A

9.3.2 Configuration

Configuring external phy loopback

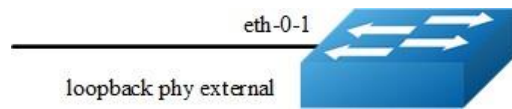

Figure 9-2 external phy topology

step 1 Enter the configure mode

```
Switch# configure terminal
```

step 2 Enter the interface configure mode and set loopback phy external

```
Switch (config)# interface eth-0-1
Switch (config-if)# no shutdown
Switch (config-if)# loopback phy external
```

step 3 Exit the configure mode

```
Switch (config-if)# end
```

step 4 Validation

```
Switch# show phy loopback
Interface  Type      DestIntf  SwapMac
-----
eth-0-1   external  -         -
-----
```

Configuring internal phy loopback



Figure 9-3 Internal phy topology

step 1 Enter the configure mode

```
Switch # configure terminal
```

step 2 Enter the interface configure mode and set loopback phy internal and specify the destination interface

```
Switch (config)# interface eth-0-2
Switch (config-if)# no shutdown
Switch (config-if)# exit

Switch (config)# interface eth-0-1
Switch (config-if)# no shutdown
Switch (config-if)# loopback phy internal eth-0-2
```

step 3 Exit the configure mode

```
Switch (config-if)# end
```

step 4 Validation

```
Switch# show phy loopback
Interface  Type      DestIntf  SwapMac
-----
eth-0-1   internal  eth-0-2   -
-----
```

Configuring port level loopback

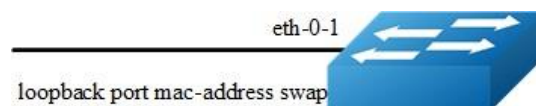

Figure 9-4 Port level topology

step 1 Enter the configure mode

```
Switch # configure terminal
```

step 2 Enter the interface configure mode and set loopback phy mac-address swap

```
Switch (config)# interface eth-0-1
Switch (config-if)# no shutdown
Switch (config-if)# loopback port mac-address swap
```

step 3 Exit the configure mode

```
Switch (config-if)# end
```

step 4 Validation

```
Switch# show phy loopback
Interface  Type      DestIntf  SwapMac
-----
eth-0-1   port     -         yes
-----
```

9.3.3 Application cases

N/A

9.4 Configuring L2 ping

9.4.1 Overview

Function Introduction

The tool L2 ping is a useful application which's purpose is detecting the connection between two switches. The L2 ping tool is not same with the well-known 'ping IP-ADDRESS' in the WINDOWS system. The normal "ping" is realized by the protocol ICMP which is dependent on the IP layer, so it may be inapplicable if the destination device is only Layer 2 switch. But the protocol used by L2 ping is only relying on Layer 2 ethernet packets.

When L2 ping is started, the L2 ping protocol packet (with ether type '36873(0x9009)') is sent from a specified physical port to another specified destination port. At the destination end, the L2 ping protocol will be sent back via non 802.1ag loopback, or via a configuration "l2 ping response". The device which is pinging, will receive the ping response packet, and print the ping result.

Principle Description

N/A

9.4.2 Configuration

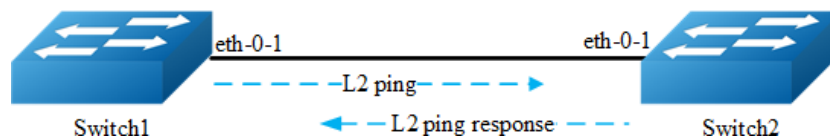

Figure 9-5 ping a switch port

The configurations are almost same on Switch1 and Switch2, except the parts which are specially pointed out.

step 1 Enter the configure mode

```
Switch# configure terminal
```

step 2 Enter the interface configure mode and turn up the interface

```
Switch (config)# interface eth-0-1
Switch (config-if)# no shutdown
```

step 3 Enable the L2 ping response function

Configure on Switch2:

```
Switch (config-if)# l2 ping response enable
```

step 4 Exit the configure mode

```
Switch (config-if)# end
```

step 5 Using L2 ping

Operate on Switch1:

```
Switch1# l2 ping 001e.0808.58f1 interface eth-0-1 count 10 interval 1000 timeout 2000
```

```
Sending 10 L2 ping message(s):
64 bytes from 001e.0808.58f1: sequence = 0, time = 10ms
64 bytes from 001e.0808.58f1: sequence = 1, time = 15ms
64 bytes from 001e.0808.58f1: sequence = 2, time = 13ms
64 bytes from 001e.0808.58f1: sequence = 3, time = 12ms
64 bytes from 001e.0808.58f1: sequence = 4, time = 20ms
64 bytes from 001e.0808.58f1: sequence = 5, time = 21ms
64 bytes from 001e.0808.58f1: sequence = 6, time = 12ms
64 bytes from 001e.0808.58f1: sequence = 7, time = 16ms
```

```
64 bytes from 001e.0808.58f1: sequence = 8, time = 14ms
64 bytes from 001e.0808.58f1: sequence = 9, time = 17ms
L2 ping completed.
-----
10 packet(s) transmitted, 10 received, 0 % packet loss
```

001e.0808.58f1 is the MAC address of the interface on Switch2. It can be gained by command "show interface eth-0-1" on Switch2.

9.4.3 Application cases

N/A

9.5 Configuring RMON

9.5.1 Overview

Function Introduction

RMON is an Internet Engineering Task Force (IETF) standard monitoring specification that allows various network agents and console systems to exchange network monitoring data. You can use the RMON feature with the Simple Network Management Protocol (SNMP) agent in the switch to monitor all the traffic flowing among switched on all connected LAN segments.

RMON is a standard monitoring specification that defines a set of statistics and functions that can be exchanged between RMON-compliant console systems and network probes RMON provides you with comprehensive network-fault diagnosis, planning, and performance-tuning information.

Principle Description

N/A

9.5.2 Configuration

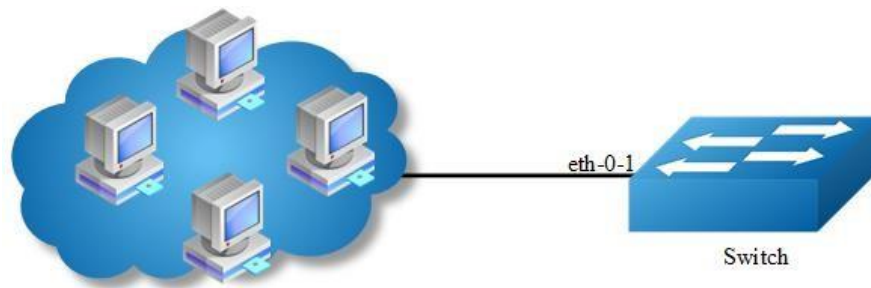

Figure 9-6 rmon

step 1 Enter the configure mode

```
Switch# configure terminal
```

step 2 Enter the interface configure mode and create a stats and a history

```
Switch(config)# interface eth-0-1
Switch(config-if)# rmon collection stats 1 owner test
Switch(config-if)# rmon collection history 1 buckets 100 interval 1000 owner test
Switch(config-if)# exit
```

step 3 Create an event with log and trap both set.

```
Switch(config)# rmon event 1 log trap public description test_event owner test
```

step 4 Create a alarm using event 1 we created before and monitor the alarm on ETHERSTATSBROADCASTPKTS on eth-0-1

```
Switch(config)# rmon alarm 1 etherStatsEntry.6.1 interval 1000 delta rising-
threshold 1000 event 1 falling-threshold 1 event 1 owner test
```

step 5 Exit the configure mode

```
Switch(config)# end
```

step 6 Validation

```
Switch# show rmon statistics
Rmon collection index 1
  Statistics ifindex = 1, Owner: test
  Input packets 0, octets 0, dropped 0
  Broadcast packets 0, multicast packets 0, CRC alignment errors 0,
collisions 0
```

```
Undersized packets 0, oversized packets 0, fragments 0, jabbers 0
# of packets received of length (in octets):
64: 0, 65-127: 0, 128-255: 0
256-511: 0, 512-1023: 0, 1024-max: 0

Switch# show rmon history
History index = 1
Data source ifindex = 1
Buckets requested = 100
Buckets granted = 100
Interval = 1000
Owner: test

Switch# show rmon event
Event Index = 1
Description: test_event
Event type Log & Trap
Event community name: public
Last Time Sent = 00:00:00
Owner: test

Switch# show rmon alarm
Alarm Index = 1
Alarm status = VALID
Alarm Interval = 1000
Alarm Type is Delta
Alarm Value = 00
Alarm Rising Threshold = 1000
Alarm Rising Event = 1
Alarm Falling Threshold = 1
Alarm Falling Event = 1
Alarm Owner is test
```

9.5.3 Application cases

N/A

9.6 Configuring SNMP

9.6.1 Overview

Function Introduction

SNMP is an application-layer protocol that provides a message format for communication between managers and agents. The SNMP system consists of an SNMP manager, an SNMP agent, and a MIB. The SNMP manager can be part of a network management system (NMS). The agent and MIB reside on the switch. To configure

SNMP on the switch, you define the relationship between the manager and the agent. The SNMP agent contains MIB variables whose values the SNMP manager can request or change. A manager can get a value from an agent or store a value into the agent. The agent gathers data from the MIB, the repository for information about device parameters and network data. The agent can also respond to a manager's requests to get or set data. An agent can send unsolicited traps to the manager. Traps are messages alerting the SNMP manager to a condition on the network. Error user authentication, restarts, link status (up or down), MAC address tracking, closing of a Transmission Control Protocol (TCP) connection, loss of connection to a neighbor, or other significant events may send a trap.

Principle Description

SNMP module is based on the following RFC draft:

- **SNMPv1:** Defined in RFC 1157.
- **SNMPv2C:** Defined in RFC 1901.
- **SNMPv3:** Defined in RFC 2273 to 2275.

Following is a brief description of terms and concepts used to describe the SNMP protocol:

- **Agent:** A network-management software module, an agent has local knowledge of management information and translates that information into a form compatible with SNMP.
- **Management Information Base (MIB):** Management Information Base, collection of information is organized hierarchically.
- **Engine ID:** A unique ID for a network's node.
- **Trap:** Used by managed devices to asynchronously report events to the NMS.

9.6.2 Configuration

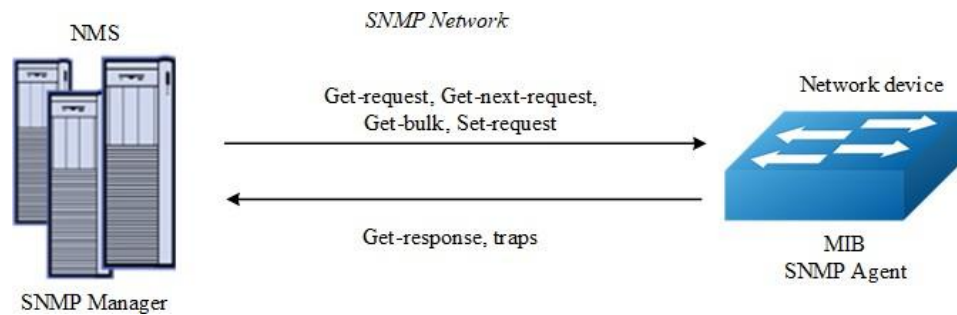

Figure 9-7 snmp

As shown in the figure SNMP agent gathers data from the MIB. The agent can send traps, or notification of certain events, to the SNMP manager, which receives and processes the traps. Traps alert the SNMP manager to a condition on the network such as improper user authentication, restarts, link status (up or down), MAC address tracking, and so forth. The SNMP agent also responds to MIB-related queries sent by the SNMP manager in get-request, get-next-request, and set-request format.

Enable SNMP

step 1 Enter the configure mode

```
Switch# configure terminal
```

step 2 Enable SNMP globally

```
Switch(config)# snmp-server enable
```

step 3 Exit the configure mode

```
Switch(config)# end
```

step 4 Validation

```
Switch# show running-config
snmp-server enable
```

Configuring community string

You use the SNMP community string to define the relationship between the SNMP manager and the agent. The community string acts like a password to permit access to the agent on the switch. Optionally, you can specify one or more of these characteristics associated with the string:

- A MIB view, which defines the subset of all MIB objects accessible to the given community
- Read and write or read-only permission for the MIB objects accessible to the community

Beginning in privileged EXEC mode, follow these steps to configure a community string on the switch.

step 1 Enter the configure mode

```
Switch# configure terminal
```

step 2 Configuring community string

Configure a view named “DUT”(optional); Configure a community named “public” with read access and view “DUT”.

```
Switch(config)# snmp-server view DUT included 1
Switch(config)# snmp-server community public read-write (view DUT)
```

step 3 Exit the configure mode

```
Switch(config)# end
```

step 4 Validation

```
Switch# show running-config
snmp-server enable
snmp-server view DUT included .1
snmp-server community public read-only view DUT
```

Configuring SNMPv3 Groups, Users and Accesses

You can specify an identification name (engine ID) for the local SNMP server engine on the switch. You can configure an SNMP server group that maps SNMP users to SNMP

views, you can add new users to the SNMP group, and you can add access for the SNMP group.

Beginning in privileged EXEC mode, follow these steps to configure SNMP on the switch.

step 1 Enter the configure mode

```
Switch# configure terminal
```

step 2 Set the global configurations for SNMP

Set engineID; Set the user name, password, and authentication type; Create SNMP server; Set the authority for the group member.

```
Switch(config)# snmp-server engineID 8000123456
Switch(config)# snmp-server usm-user usrl authentication md5 mypassword privacy des yourpassword
Switch(config)# snmp-server group grp1 user usrl security-model usm
Switch(config)# snmp-server access grp1 security-model usm noauth
```

step 3 Exit the configure mode

```
Switch(config)# end
```

step 4 Validation

```
Switch# show running-config
snmp-server engineID 8000123456
snmp-server usm-user usrl authentication md5 mypassword privacy des yourpassword
snmp-server group grp1 user usrl security-model usm
snmp-server access grp1 security-model usm noauth
```

SNMPv1 and SNMPv2 notifications configure

Beginning in privileged EXEC mode, follow these steps to configure SNMP on the switch.

step 1 Enter the configure mode

```
Switch# configure terminal
```

step 2 Set the global configurations for SNMP

Enable all supported traps; Configure a remote trap manager which IP is “10.0.0.2”;
Configure a remote trap manager which IPv6 address is “2001:1000::1”.

```
Switch(config)# snmp-server trap enable all
Switch(config)# snmp-server trap target-address 10.0.0.2 community public
Switch(config)# snmp-server trap target-address 2001:1000::1 community public
```

step 3 Exit the configure mode

```
Switch(config)# end
```

step 4 Validation

```
Switch# show running-config
snmp-server trap target-address 10.0.0.2 community public
snmp-server trap target-address 2001:1000::1 community public
snmp-server trap enable vrrp
snmp-server trap enable igmp snooping
snmp-server trap enable ospf
snmp-server trap enable pim
snmp-server trap enable stp
snmp-server trap enable system
snmp-server trap enable coldstart
snmp-server trap enable warmstart
snmp-server trap enable linkdown
snmp-server trap enable linkup
```

Configuring SNMPv3 notifications

step 1 Enter the configure mode

```
Switch# configure terminal
```

step 2 Set the global configurations for SNMP

Enable all supported traps; Configure a trap notify item for SNMPv3; Configure a remote trap manager’s IP address; Configure a remote trap manager’s IPv6 address; Add a local user to SNMPv3 notifications.

```
Switch(config)# snmp-server trap enable all
Switch(config)# snmp-server notify notif1 tag tmptag trap
Switch(config)# snmp-server target-address targ1 param parm1 10.0.0.2 taglist
tmptag
Switch(config)# snmp-server target-address t1 param p1 2001:1000::1 taglist tag1
Switch(config)# snmp-server target-params parm1 user usr1 security-model v3
message-processing v3 noauth
```

step 3 Exit the configure mode

```
Switch(config)# end
```

step 4 Validation

```
Switch# show running-config
snmp-server notify notif1 tag tmptag trap
snmp-server target-address t1 param p1 2001:1000::1 taglist tag1
snmp-server target-address targ1 param parm1 10.0.0.2 taglist tmptag
snmp-server target-params parm1 user usr1 security-model v3 message-processing v3
noauth
snmp-server trap enable vrrp
snmp-server trap enable igmp snooping
snmp-server trap enable ospf
snmp-server trap enable pim
snmp-server trap enable stp
snmp-server trap enable system
snmp-server trap enable coldstart
snmp-server trap enable warmstart
snmp-server trap enable linkdown
snmp-server trap enable linkup
```

9.6.3 Application cases

N/A

9.7 Configuring SFLOW

9.7.1 Overview

Function Introduction

sFlow is a technology for monitoring traffic in data networks containing switches and routers. In particular, it defines the sampling mechanisms implemented in a sFlow Agent for monitoring traffic, and the format of sample data used by the sFlow Agent when forwarding data to a central data collector.

The architecture and sampling techniques used in the sFlow monitoring system are designed to provide continuous site-wide (and network-wide) traffic monitoring for high speed switched and routed networks.

The sFlow Agent uses two forms of sampling: statistical packet-based sampling of switched flows, and time-based sampling of network interface statistics.

Default Configuration for sflow:

Feature	Default Setting
global sflow	disabled
sflow on port	disable
collector udp port	6343
counter interval time	20 seconds

Principle Description

N/A

9.7.2 Configuration

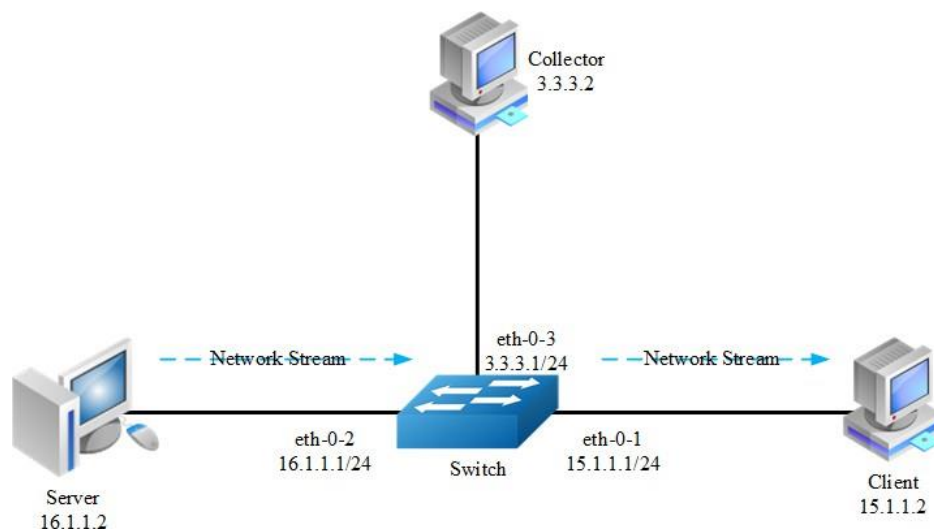

Figure 9-8 sflow

step 1 Enter the configure mode

```
Switch# configure terminal
```

step 2 Enable sflow globally

```
Switch(config)# sflow enable
```

step 3 Set the global attribute for sflow

Set the agent IP address, set the collector IP address and udp port. If the udp port is not specified, it means default port 6364.

```
Switch(config)# sflow agent ip 3.3.3.1
Switch(config)# sflow collector 3.3.3.2 6342
```

Set the agent and collector with IPv6:

```
Switch(config)# sflow agent ipv6 2001:2000::2
Switch(config)# sflow collector 2001:2000::1
```



NOTE

At list one Agent and one collector must be configured for sflow. User can use IPv4 or IPv6.

Set the interval to send interface counter information (optional):

```
Switch(config)# sflow counter interval 15
```

step 4 Enter the interface configure mode and set the attributes of the interfaces

```
Switch(config)# interface eth-0-1
Switch(config-if)# no switchport
Switch(config-if)# no shutdown
Switch(config-if)# ip address 15.1.1.1/24
Switch(config-if)# exit
```

```
Switch(config)# interface eth-0-2
Switch(config-if)#no switchport
Switch(config-if)# no shutdown
Switch(config-if)# ip address 16.1.1.1/24
Switch(config-if)# exit
```

```
Switch(config)# interface eth-0-3
Switch(config-if)# no switchport
Switch(config-if)# no shutdown
Switch(config-if)# ip address 3.3.3.1/24
Switch(config-if)# exit
```

step 5 Enable sflow for input packets on eth-0-1

```
Switch(config)# interface eth-0-1
Switch(config-if)# sflow flow-sampling rate 8192
Switch(config-if)# sflow flow-sampling enable input
Switch(config-if)# sflow counter-sampling enable
Switch(config-if)# exit
```

step 6 Validation

To display the sflow configuration, use following command:

```
Switch# show sflow
sFlow Version: 5
sFlow Global Information:
Agent IPv4 address      : 3.3.3.1
Agent IPv6 address      : 2001:1000::2
Counter Sampling Interval : 15 seconds
Collector 1:
  IPv4 Address: 3.3.3.2
  vrf: N/A
  Port: 6342
Collector 2:
  IPv6 Address: 2001:1000::1
  vrf: N/A
  Port: 6343

sFlow Port Information:
```

Port	Counter	Flow	Flow-Sample Direction	Flow-Sample Rate
eth-0-1	Enable	Enable	Input	8192

9.7.3 Application cases

N/A

9.8 Configuring LLDP

9.8.1 Overview

Function Introduction

LLDP (Link Layer Discovery Protocol) is the discovery protocol on link layer defined as standard in IEEE 802.1ab. Discovery on Layer 2 can locate interfaces attached to the devices exactly with connection information on layer 2, such as VLAN attribute of port and protocols supported, and present paths among client, switch, router, application servers and other network servers. This detailed description is helpful to get useful information for diagnosing network fast, like topology of devices attached, conflict configuration between devices, and reason of network failure.

Principle Description

N/A

9.8.2 Configuration

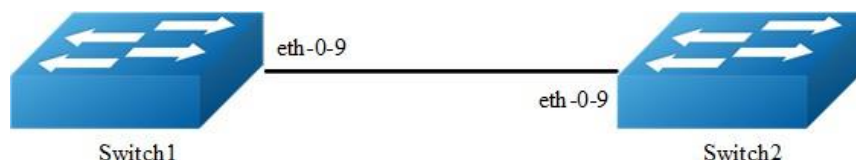

Figure 9-9 lldp

step 1 Enter the configure mode

```
Switch# configure terminal
```

step 2 Enable SNMP globally

```
Switch(config)# lldp enable
```

step 3 Enter the interface configure mode and set the attributes of LLDP on the interface

```
Switch(config)# interface eth-0-9
Switch(config)# no shutdown
Switch(config-if)# no lldp tlv 8021-org-specific vlan-name
Switch(config-if)# lldp tlv med location-id ecs-elin 1234567890
Switch(config-if)# lldp enable txrx
Switch(config-if)# exit
```

step 4 Set LLDP timers (optional)

Configure the transmitting interval of LLDP packet to 40 seconds; Configure the transmitting delay of LLDP packet to 3 seconds; Configure the reinit delay of LLDP function to 1 second.

```
Switch(config)# lldp timer msg-tx-interval 40
Switch(config)# lldp timer tx-delay 3
Switch(config)# lldp timer reinitDelay 1
```

step 5 Exit the configure mode

```
Switch(config)# end
```

step 6 Validation

To display the LLDP configuration, use following command:

```
Switch# show lldp local config
LLDP global configuration:
=====
LLDP function global enabled : YES
LLDP msgTxHold      : 4
LLDP msgTxInterval : 40
LLDP reinitDelay   : 1
LLDP txDelay       : 3
Switch# show lldp local config interface eth-0-9
LLDP configuration on interface eth-0-9 :
=====
LLDP admin status : TXRX
Basic optional TLV Enabled:
  Port Description TLV
  System Name TLV
  System Description TLV
  System Capabilities TLV
  Management Address TLV
IEEE 802.1 TLV Enabled:
  Port Vlan ID TLV
  Port and Protocol Vlan ID TLV
  Protocol Identity TLV
IEEE 802.3 TLV Enabled:
  MAC/PHY Configuration/Status TLV
  Power Via MDI TLV
  Link Aggregation TLV
  Maximum Frame Size TLV
LLDP-MED TLV Enabled:
  Med Capabilities TLV
  Network Policy TLV
  Location Identification TLV
  Extended Power-via-MDI TLV
  Inventory TLV
Switch# show running-config
!
lldp enable
lldp timer msg-tx-interval 40
lldp timer reinit-delay 1
lldp timer tx-delay 3
!
interface eth-0-9
lldp enable txrx
 no lldp tlv 8021-org-specific vlan-name
  lldp tlv med location-id ecs-elin 1234567890
!
Switch# show lldp neighbor
Local Port eth-0-1 has 0 neighbor(s)

Local Port eth-0-2 has 0 neighbor(s)
...
Local Port eth-0-9 has 2 neighbor(s)
```

```
Remote LLDP Information of port eth-0-9
=====
Neighbor Index : 1
Chassis ID type: Mac address
Chassis ID      : 48:16:be:a4:d7:09
Port ID type    : Interface Name
Port ID        : eth-0-9
TTL : 160
Expired time: 134
...
Location Identification :
ECS ELIN: 1234567890
```

9.9 Configuring IPFIX

9.9.1 Overview

Function Introduction

Traffic on a data network can be seen as consisting of flows passing through network elements. For administrative or other purposes, it is often interesting, useful, or even necessary to have access to information about these flows that pass through the network elements. This requires uniformity in the method of representing the flow information and the means of communicating the flows from the network elements to the collection point. This is what IPFIX can do.

Before IPFIX was introduced, there is a Cisco private method NetFlow. IPFIX is similar to NetFlow and is based on NetFlow version 9.

Principle Description

N/A

9.9.2 Configuration

step 1 Enter the configure mode

```
Switch# configure terminal
```

step 2 Set the aging time(optional)

Set the aging time as 300 seconds. The aging time is 1800 seconds by default.

```
Switch(config)# ipfix global
Switch(Config-ipfix-global)# flow aging 300
```

step 3 Configuring recorder

```
Switch(config)# ipfix recorder recorder1
Switch(Config-ipfix-reocrder)# match mac source address
Switch(Config-ipfix-reocrder)# match ipv4 source address mask 32
Switch(Config-ipfix-reocrder)# match ipv4 destination address mask 32
Switch(Config-ipfix-reocrder)# match vxlan-vni
Switch(Config-ipfix-reocrder)# collect counter bytes
Switch(Config-ipfix-reocrder)# collect counter packets
Switch(Config-ipfix-reocrder)# exit
```

step 4 Configuring sampler

```
Switch(config)# ipfix sampler sampler1
Switch(Config-ipfix-sampler)# 1 out-of 100
Switch(Config-ipfix-sampler)# exit
```

step 5 Configuring exporter

```
Switch(config)# ipfix exporter exporter1
Switch(Config-ipfix-exporter)# destination 10.10.10.1
Switch(Config-ipfix-exporter)# source interface eth-0-2
Switch(Config-ipfix-exporter)# flow data timeout 200
Switch(Config-ipfix-exporter)# event flow end timeout
Switch(Config-ipfix-exporter)# exit
```

step 6 Configuring monitor

```
Switch(config)# ipfix monitor monitor1
Switch(Config-ipfix-monitor)# recorder recorder1
Switch(Config-ipfix-monitor)# exporter exporter1
Switch(Config-ipfix-monitor)# exit
```

step 7 Enter the interface configure mode and apply ipfix

```
Switch(config)# interface eth-0-1
Switch(config-if)# ipfix monitor input monitor1 sampler sampler1
Switch(config-if)# exit
```

step 8 Exit the configure mode

```
Switch(config)# end
```

step 9 Validation

Use the following commands to validate the configuration:

```
Switch# show ipfix global
IPFIX global information:
  Current flow cache number           : 0(ingress: 0, egress: 0)
  Flow cache aging interval           : 300 seconds
  Flow cache export interval          : 5 seconds
  Flow cache memory usage threshold   : 90%
  Flow cache sampler mode              : all flow
  Flow cache packet wraparound threshold : 67108863
  Flow cache byte wraparound threshold : 4294967295
  Flow cache dropped packet wraparound threshold : 1023
  Flow cache jitter threshold         : 65535
  Flow cache latency threshold        : 16777215

Switch# show ipfix recorder recorder1
IPFIX recorder information:
  Name           : recorder1
  Description    :
  Match info    :
    match Source Mac Address
    match IPv4 Source Address
    match IPv4 Destination Address
    match Vxlanvni
  Collect info  :
    collect Flow Byte Number
    collect Flow Packet Number

Switch# show ipfix exporter exporter1
IPFIX exporter information:
  Name           : exporter1
  Description    :
  Exporter Interface : eth-0-2
  Domain ID      : 0
  Collector Name  : 10.10.10.1
  IPFIX message protocol : UDP
  IPFIX message destination Port : 2055
  IPFIX message TTL value : 255
  IPFIX message DSCP value : 63
  IPFIX data interval : 200
  IPFIX template interval : 1800
  IPFIX exporter events :
    Flow aging event

Switch# show ipfix sampler sampler1
IPFIX sampler information:
  Name           : sampler1
  Description    :
  Rate           : 100

Switch# show ipfix monitor monitor1
IPFIX monitor information:
  Name           : monitor1
```

Description	:
Recorder	: recorder1
exporter	: exporter1
flow mirror packet	: 0
flow mirror destination	: NA

9.9.3 Application cases

N/A

9.10 PTP Configuration Guide

9.10.1 Overview

Function Introduction

The Precision Time Protocol (PTP), as defined in the IEEE 1588 standard, synchronizes with nanosecond accuracy the real-time clocks of the devices in a network. The clocks are organized into a master-member hierarchy. PTP identifies the switch port that is connected to a device with the most precise clock. This clock is referred to as the master clock. All the other devices on the network synchronize their clocks with the master and are referred to as members. Constantly exchanged timing messages ensure continued synchronization.

PTP is particularly useful for industrial automation systems and process control networks, where motion and precision control of instrumentation and test equipment are important.

You can globally configure the switch to pass PTP packets through the switch as normal multicast traffic (PTP disabled), to synchronize all switch ports with the grand master clock (transparent mode), or you can configure boundary (or ordinary) clock mode, where the switch participates in selecting the best master clock and can act as the master clock if no better clocks are detected.

Principle Description

Reference to IEEE 1588-2008

Terminology

Terminology	Description
GPS	Global Positioning System
NTP	Network Time Protocol
PTP	Precision Time Protocol
UTC	Coordinated Universal Time
TAI	International Atomic Time

9.10.2 Default Configuration

Feature	Default Setting
PTP clock	Disabled
PTP device type	Ordinary clock
PTP priority1 and PTP priority2	Default priority number is 128
PTP step mode	Two step
PTP announce interval	2 seconds
PTP announce timeout	8 seconds
PTP delay request interval	1 second
PTP peer delay request interval	1 second
PTP sync interval	1 second

9.10.3 Configurations



Figure 9-10 PTP Timing Domain

Configure Peer Timing Domain with Boundary Clock

Step 1: Configure Switch1 to be an ordinary clock

Configure Switch1 to be an ordinary clock with priority1 0. This will lead the Switch have the highest priority in this PTP timing domain, that means, the master of this domain.

Enable PTP globally and Set the priority1 properties to 0. Enter the interface mode, set the delay mechanism to peer mode and enable PTP on interface.

```
Switch# configure terminal
Switch(config)# ptp global-enable
Switch(config)# ptp priority1 0
Switch(config)# interface eth-0-9
Switch(config-if)# ptp delay-mechanism peer
Switch(config-if)# ptp enable
```

Step 2: Configure Switch2 to be a boundary clock

Set the device type to boundary clock and enable PTP globally. Enter the interface mode and set the delay mechanism to peer mode. Enable PTP on interface.

```
Switch# configure terminal
Switch(config)# ptp device-type bc
Switch(config)# ptp global-enable
Switch(config)# interface eth-0-9
Switch(config-if)# ptp delay-mechanism peer
Switch(config-if)# ptp enable
Switch(config)# interface eth-0-18
Switch(config-if)# ptp delay-mechanism peer
Switch(config-if)# ptp enable
```

Step 3: Configure Switch3 to be an ordinary clock

Enable PTP globally and set the slave-only properties to TRUE. Enter the interface mode and set the delay mechanism to peer mode. Enable PTP on interface.

```
Switch# configure terminal
Switch(config)# ptp global-enable
Switch(config)# ptp slave-only
Switch(config)# interface eth-0-18
Switch(config-if)# ptp delay-mechanism peer
Switch(config-if)# ptp enable
```

Step 4: Validation

Verify the PTP global state on Switch1

```
Switch# show ptp
----- Global Configure
PTP State           : enable
Port Number        : 1
Domain             : 0
Slave Only         : false
Clock Type         : ordinary clock
Priority1          : 0
Priority2          : 128
Clock Accuracy     : 0xfe
Clock Class        : 248
Time Source        : internal-oscillator(160)
UTC Offset         : 34
Leap59             : false
Leap61             : false
Local Clock Identity : 60:4D:39:FF:FE:FF:C5:00
Set systime via PTP: : false
----- BMC Properties
Receive Member     : (null)
Parent Clock Identity : 60:4D:39:FF:FE:FF:C5:00
Parent Port Number : 0
Mean Path Delay    : 0
Offset From Master : 0
Step Removed       : 0
GM Clock Identity  : 60:4D:39:FF:FE:FF:C5:00
GM Priority1       : 0
GM Priority2       : 128
GM Clock Accuracy  : 0xfe
GM Clock Class     : 248
GM Time Source     : internal-oscillator(160)
GM UTC Offset      : 34
GM UTC Offset Valid : false
GM Time Scale      : PTP
GM Time Traceable  : false
GM Leap59          : false
GM Leap61          : false
GM Frequency Traceable : false
```

Verify the PTP port state on Switch1

```
Switch# show ptp interface eth-0-9
-----
Interface           : eth-0-9
----- Port Configure -----
PTP state           : enable
Port ID             : 60:4D:39:FF:FE:FF:C5:0009
Delay Mechanism     : peer
Step Mode           : two
Port State          : master
Announce Interval   : 1
Sync Interval       : 0
```

```

Announce Receipt Timeout      : 4
PDelay_Req Interval          : 0
Peer Mean Path Delay          : 0
----- port statistic
Recv Packet Statistics
-----
Announce      : 5          Sync          : 0
Delay_Req     : 0          Pdelay_Req      : 5248
Delay_Resp    : 0          Pdelay_Resp     : 5249
Follow_Up     : 0          Pdelay_Resp_Follow_Up : 5249
Unknown       : 0
Send Packet Statistics
-----
Announce      : 5345       Sync          : 10609
Delay_Req     : 0          Pdelay_Req      : 10617
Delay_Resp    : 0          Pdelay_Resp     : 5248
Follow_Up     : 10607     Pdelay_Resp_Follow_Up : 5248
Unknown       : 0
Discard Packet Statistics
-----
Announce      : 0          Sync          : 9
Delay_Req     : 0          Pdelay_Req      : 0
Delay_Resp    : 0          Pdelay_Resp     : 0
Follow_Up     : 9          Pdelay_Resp_Follow_Up : 0
Unknown       : 0

```

Verify the PTP global state on Switch2

```

Switch# show ptp
----- Global Configure
PTP State      : enable
Port Number    : 2
Domain         : 0
Slave Only     : false
Clock Type     : boundary clock
Priority1      : 128
Priority2      : 128
Clock Accuracy : 0xfe
Clock Class    : 248
Time Source    : internal-oscillator(160)
UTC Offset     : 34
Leap59        : false
Leap61        : false
Local Clock Identity : 5E:C4:DC:FF:FE:AE:78:00
Set systime via PTP: : false
----- BMC Properties -----
Receive Member : eth-0-9
Parent Clock Identity : 60:4D:39:FF:FE:FF:C5:00
Parent Port Number : 9
Mean Path Delay : 0
Offset From Master : 0
Step Removed     : 1
GM Clock Identity : 60:4D:39:FF:FE:FF:C5:00
GM Priority1     : 0
GM Priority2     : 128
GM Clock Accuracy : 0xfe

```

```

GM Clock Class      : 248
GM Time Source      : internal-oscillator(160)
GM UTC Offset       : 34
GM UTC Offset Valid : false
GM Time Scale       : PTP
GM Time Traceable   : false
GM Leap59           : false
GM Leap61           : false
GM Frequency Traceable : false

```

Verify the PTP foreign master on Switch2

```

Switch# show ptp foreign-master
Foreign_master_port_identity  Qualification  Interface
-----
*60:4D:39:FF:FE:FF:C5:00@9   true          eth-0-9

```

Verify the PTP port state on Switch2

```

Switch# show ptp interface eth-0-9
-----
Interface          : eth-0-9
-----
Port Configure
-----
PTP state          : enable
Port ID           : 5E:C4:DC:FF:FE:AE:78:00@9
Delay Mechanism    : peer
Step Mode         : two
Port State        : slave
Announce Interval : 1
Sync Interval     : 0
Announce Receipt Timeout : 4
PDelay_Req Interval : 0
Peer Mean Path Delay : 0
-----
Port Statistic
-----
Recv Packet Statistics
-----
Announce          : 2944          Sync          : 5837
Delay_Req         : 0            Pdelay_Req    : 5876
Delay_Resp       : 0            Pdelay_Resp   : 5876
Follow_Up        : 5837         Pdelay_Resp_Follow_Up : 5875
Unknown          : 0
Send Packet Statistics
-----
Announce          : 15           Sync          : 30
Delay_Req         : 0            Pdelay_Req    : 5876
Delay_Resp       : 0            Pdelay_Resp   : 5876
Follow_Up        : 27           Pdelay_Resp_Follow_Up : 5876
Unknown          : 0
Discard Packet Statistics
-----
Announce          : 0            Sync          : 9
Delay_Req         : 0            Pdelay_Req    : 0
Delay_Resp       : 0            Pdelay_Resp   : 0
Follow_Up        : 9            Pdelay_Resp_Follow_Up : 0
Unknown          : 0

```

```

Switch# show ptp interface eth-0-18
-----
Interface                : eth-0-18
-----
Port Configure
-----
PTP state                 : enable
Port ID                  : 5E:C4:DC:FF:FE:AE:78:00@18
Delay Mechanism          : peer
Step Mode                : two
Port State               : master
Announce Interval       : 1
Sync Interval           : 0
Announce Receipt Timeout : 4
PDelay_Req Interval     : 0
Peer Mean Path Delay    : 0
-----
Port Statistic
-----
Recv Packet Statistics
-----
Announce                 : 0          Sync                 : 0
Delay_Req                : 0          Pdelay_Req           : 5680
Delay_Resp               : 0          Pdelay_Resp          : 5680
Follow_Up                : 0          Pdelay_Resp_Follow_Up : 5680
Unknown                  : 0
Send Packet Statistics
-----
Announce                 2950          Sync                 : 5860
Delay_Req                : 0          Pdelay_Req           : 5868
Delay_Resp               : 0          Pdelay_Resp          : 5680
Follow_Up                : 5858          Pdelay_Resp_Follow_Up : 5680
Unknown                  : 0
Discard Packet Statistics
-----
Announce                 : 0          Sync                 : 0
Delay_Req                : 0          Pdelay_Req           : 0
Delay_Resp               : 0          Pdelay_Resp          : 0
Follow_Up                : 0          Pdelay_Resp_Follow_Up : 0
Unknown                  : 0

```

Verify the PTP global state on Switch3

```

Switch# show ptp
-----
Global Configure
-----
PTP State                 : enable
Port Number              : 1
Domain                   : 0
Slave Only               : true
Clock Type               : ordinary clock
Priority1                 : 128
Priority2                 : 128
Clock Accuracy           : 0xfe
Clock Class              : 255
Time Source              : internal-oscillator(160)
UTC Offset               : 34
Leap59                   : false
Leap61                   : false
Local Clock Identity     : A0:D2:25:FF:FE:B1:F8:00
Set systime via PTP     : false

```

```

----- BMC Properties -----
Receive Member          : eth-0-18
Parent Clock Identity   : 5E:C4:DC:FF:FE:AE:78:00
Parent Port Number     : 18
Mean Path Delay        : 0
Offset From Master     : 0
Step Removed           : 2
GM Clock Identity      : 60:4D:39:FF:FE:FF:C5:00
GM Priority1           : 0
GM Priority2           : 128
GM Clock Accuracy      : 0xfe
GM Clock Class         : 248
GM Time Source         : internal-oscillator(160)
GM UTC Offset          : 34
GM UTC Offset Valid    : false
GM Time Scale          : PTP
GM Time Traceable     : false
GM Leap59              : false
GM Leap61              : false
GM Frequency Traceable : false

```

Verify the PTP foreign master on Switch3

```

Switch# show ptp foreign-master
Foreign_master_port_identity  Qualification  Interface
-----
*5E:C4:DC:FF:FE:AE:78:00@18  true          eth-0-18

```

Verify the PTP port state on Switch3

```

Switch# show ptp interface eth-0-18
-----
Interface          : eth-0-18
-----
Port Configure
PTP state          : enable
Port ID           : A0:D2:25:FF:FE:B1:F8:00@18
Delay Mechanism    : peer
Step Mode          : two
Port State         : slave
Announce Interval  : 1
Sync Interval      : 0
Announce Receipt Timeout : 4
PDelay_Req Interval : 0
Peer Mean Path Delay : 0
-----
Port Statistic
Recv Packet Statistics
-----
Announce          : 3472          Sync          : 6884
Delay_Req         : 0            Pdelay_Req    : 6919
Delay_Resp        : 0            Pdelay_Resp   : 6917
Follow_Up         : 6884          Pdelay_Resp_Follow_Up : 6917
Unknown          : 0
Send Packet Statistics
-----
Announce          : 0            Sync          : 0
Delay_Req         : 0            Pdelay_Req    : 6920

```



```

Delay_Resp      : 0          Pdelay_Resp          : 6919
Follow_Up       : 0          Pdelay_Resp_Follow_Up : 6919
Unknown        : 0
Discard Packet Statistics
-----
Announce        : 0          Sync              : 11
Delay_Req       : 0          Pdelay_Req        : 0
Delay_Resp      : 0          Pdelay_Resp       : 3
Follow_Up       : 11         Pdelay_Resp_Follow_Up : 3
Unknown        : 0

```

Configure Peer Timing Domain with Transparent Clock

Step 1: Change Switch2 from boundary clock to transparent clock.

Set the device type to peer-to-peer transparent clock and enable PTP globally. Enter the interface mode and enable PTP on interface.

```

Switch# configure terminal
Switch(config)# ptp device-type p2ptc
Switch(config)# ptp global-enable
Switch(config)# interface range eth-0-9 , 18
Switch(config-if)# ptp enable

```

Step 2: Validation

Verify the PTP global state on Switch2

```

Switch# show ptp
----- Global Configure -----
PTP State          : enable
Port Number        : 2
Primary Domain     : 0
Clock Type         : peer-to-peer transparent clock
Local Clock ID     : 5E:C4:DC:FF:FE:AE:78:00

```

Verify the PTP port state on Switch2

```

Switch# show ptp interface eth-0-9
-----
Interface          : eth-0-9
----- Port Configure -----
PTP state          : enable
Port ID           : 5E:C4:DC:FF:FE:AE:78:00@9
Delay Mechanism    : peer
Step Mode          : two
Port State         : normal
PDelay_Req Interval : 0
Peer Mean Path Delay : 0
----- Port Statistic -----
Recv Packet Statistics

```

```

-----
Announce           : 6545           Sync           : 12985
Delay_Req          : 0             Pdelay_Req     : 13024
Delay_Resp         : 0             Pdelay_Resp    : 13016
Follow_Up         : 12985         Pdelay_Resp_Follow_Up : 13016
Unknown           : 0
Send Packet Statistics
-----
Announce           : 15             Sync           : 30
Delay_Req          : 0             Pdelay_Req     : 13021
Delay_Resp         : 0             Pdelay_Resp    : 13024
Follow_Up         : 27             Pdelay_Resp_Follow_Up : 13024
Unknown           : 0
Discard Packet Statistics
-----
Announce           : 0             Sync           : 9
Delay_Req          : 0             Pdelay_Req     : 0
Delay_Resp         : 0             Pdelay_Resp    : 5
Follow_Up         : 9             Pdelay_Resp_Follow_Up : 5
Unknown           : 0

Switch# show ptp interface eth-0-18
-----
Interface           : eth-0-18
-----
Port Configure
-----
PTP state           : enable
Port ID             : 5E:C4:DC:FF:FE:AE:78:00@18
Delay Mechanism     : peer
Step Mode           : two
Port State          : normal
PDelay_Req Interval : 0
Peer Mean Path Delay : 0
-----
Port Statistic
-----
Recv Packet Statistics
-----
Announce           : 0             Sync           : 0
Delay_Req          : 0             Pdelay_Req     : 13026
Delay_Resp         : 0             Pdelay_Resp    : 13019
Follow_Up         : 0             Pdelay_Resp_Follow_Up : 13019
Unknown           : 0
Send Packet Statistics
-----
Announce           : 6651           Sync           : 13208
Delay_Req          : 0             Pdelay_Req     : 13212
Delay_Resp         : 0             Pdelay_Resp    : 13026
Follow_Up         : 13208         Pdelay_Resp_Follow_Up : 13026
Unknown           : 0
Discard Packet Statistics
-----
Announce           : 0             Sync           : 0
Delay_Req          : 0             Pdelay_Req     : 0
Delay_Resp         : 0             Pdelay_Resp    : 6
Follow_Up         : 0             Pdelay_Resp_Follow_Up : 6
Unknown           : 0

```

Verify the PTP global state on Switch3

```

Switch# show ptp
----- Global Configure
PTP State           : enable
Port Number         : 1
Domain              : 0
Slave Only          : true
Clock Type          : ordinary clock
Priority1            : 128
Priority2            : 128
Clock Accuracy      : 0xfe
Clock Class         : 255
Time Source         : internal-oscillator(160)
UTC Offset          : 34
Leap59              : false
Leap61              : false
Local Clock Identity : A0:D2:25:FF:FE:B1:F8:00
Set systemtime via PTP: : false
----- BMC Properties
Receive Member      : eth-0-18
Parent Clock Identity : 60:4D:39:FF:FE:FF:C5:00
Parent Port Number  : 9
Mean Path Delay     : 0
Offset From Master  : 0
Step Removed        : 1
GM Clock Identity   : 60:4D:39:FF:FE:FF:C5:00
GM Priority1        : 0
GM Priority2        : 128
GM Clock Accuracy   : 0xfe
GM Clock Class      : 248
GM Time Source      : internal-oscillator(160)
GM UTC Offset       : 34
GM UTC Offset Valid : false
GM Time Scale       : PTP
GM Time Traceable   : false
GM Leap59           : false
GM Leap61           : false
GM Frequency Traceable : false

```

Verify the PTP foreign master on Switch3

```

Switch# show ptp foreign-master
Foreign_master_port_identity  Qualification  Interface
-----
*60:4D:39:FF:FE:FF:C5:00@9   true          eth-0-18

```

10 Traffic Management Configuration Guide

10.1 Configuring QoS

10.1.1 Overview

Function Introduction

Quality of Service (QoS) can be used to give certain traffic priority over other traffic. Without QoS, all traffic in a network has the same priority and chance of being delivered on time. If congestion occurs, all traffic has the same chance of being dropped. With QoS, specific network traffic can be prioritized to receive preferential treatment. In turn, a network performs more predictably, and utilizes bandwidth more effectively.

Classification information can be carried in the Layer-3 IP packet header or the Layer-2 frame. IP packet headers carry the information using 6 bits or 3 bits from the deprecated IP type of service (TOS) field. Layer-2 802.1Q frames carry the information using a 2-byte Tag Control Information field.

All switches and routers accessing the Internet depend on class information to give the same forwarding treatment to packets with the same class information, and give different treatment to packets with different class information. A packet can be assigned class information, as follows:

- End hosts or switches along a path, based on a configured policy
- Detailed packet examination, expected to occur nearer to the network edge, to prevent overloading core switches and routers
- A combination of the above two techniques

Class information can be used by switches and routers along a path to limit the amount of allotted resources per traffic class.

Per-hop behavior is an individual device's behavior when handling traffic in the DiffServ architecture. An end-to-end QoS solution can be created if all devices along a path have consistent per-hop behavior.

Principle Description

Following is a brief description of terms and concepts used to describe QoS:

ACL

Access control lists (ACLs) classify traffic with the same characteristics. IP traffic is classified using IP ACLs, and non-IP traffic is classified using MAC ACLs. The ACL can have multiple access control entries (ACEs), which are commands that match fields against the contents of the packet.

CoS Value

Class of Service (CoS) is a 3-bit value used to classify the priority of Layer-2 frames upon entry into a network.

QoS classifies frames by assigning priority-indexed CoS values to them, and gives preference to higher-priority traffic.

Layer-2 802.1Q frame headers have a 2-byte Tag Control Information field that carries the CoS values in the 3 most significant bits, called the User Priority bits. On interfaces configured as Layer-2 802.1Q trunks, all traffic is in 802.1Q frames, except for traffic in the native VLAN.

Other frame types cannot carry Layer-2 CoS values. CoS values range from 0 to 7.

DSCP Value

Differentiated Services Code Point (DSCP) is a 6-bit value used to classify the priority of Layer-3 packets upon entry into a network.

DSCP values range from 0 to 63.

IP-Precedence Value

IP-Precedence is a 3-bit value used to classify the priority of Layer-3 packets upon entry into a network.

IP-Precedence values range from 0 to 7.

EXP Value

EXP value is a 3-bit value used to classify the priority of MPLS packets upon entry into a network.

MPLS EXP values range from 0 to 7.

Classification

Classification distinguishes one kind of traffic from another by examining the fields in the packet. The process generates an internal priority for a packet, which identifies all future QoS actions to be taken on the packet.

Each packet is classified upon entry into the network. At the ingress, the packet is inspected, and the priority is determined based on ACLs or the configuration. The Layer-2 CoS value is then mapped to a priority value.

The classification is carried in the IP packet header using 6 bits or 3 bits from the deprecated IP TOS field to carry the classification information. Classification can also occur in the Layer-2 frame.

Classification occurs on an ingress physical port, but not at the switch virtual interface level.

Classification can be based on CoS/inner-CoS/DSCP/IP-Precedence, default port cos, or class maps and policy maps.

Shaping

Shaping is to change the rate of incoming traffic flow to regulate the rate in such a way that the outgoing traffic flow behaves more smoothly. If the incoming traffic is highly bursty, it needs to be buffered so that the output of the buffer is less bursty and smoother.

Shaping has the following attributes:

- Shaping can be deployed base on physical port.
- Shaping can be deployed on queues of egress interface.

Policing

Policing determines whether a packet is in or out of profile by comparing the internal priority to the configured policer.

The policer limits the bandwidth consumed by a traffic flow. The result is given to the marker.

There are two types of policers:

- Individual: QoS applies the bandwidth limits specified in the policer, separately, to each matched traffic class. An individual policer is configured within a policy map.
- Aggregate: QoS applies the bandwidth limits specified in an aggregate policer, cumulatively, to all matched traffic flows. An aggregate policer is configured by specifying the policer name within a policy map. The bandwidth limits of the policer are specified. In this way, the aggregate policer is shared by multiple classes of traffic within one or multiple policy map.

Marking

Marking determines how to handle a packet when it is out of profile. It assesses the policer and the configuration information to determine the action required for the packet, and then handles the packet using one of the following methods:

- Let the packet through and mark color down
- Drop the packet

Marking can occur on ingress and egress interfaces.

Queuing

Queuing maps packets to a queue. Each egress port can accommodate up to 8 unicast queues, 1 multicast queue and 1 SPAN queue.

The packet internal priority can be mapped to one of the egress queues. The unit of queue depth is buffer cell. Buffer cell is the granularity, which is 288 bytes, for packet storing.

After the packets are mapped to a queue, they are scheduled.

Tail Drop

Tail drop is the default congestion-avoidance technique on the interface. With tail drop, packets are queued until the thresholds are exceeded. The packets with different priority and color are assigned to different drop precedence. The mapping between priority and color to queue and drop precedence is configurable. You can modify the three tail-drop threshold to every egress queue by using the queue threshold interface configuration command. Each threshold value is packet buffer cell.

WRED

Weighted Random Early Detection (WRED) differs from other congestion-avoidance techniques because it attempts to anticipate and avoid congestion, rather than controlling congestion when it occurs.

WRED reduces the chances of tail drop by selectively dropping packets when the output interface begins to show signs of congestion. By dropping some packets early rather than waiting until the queue is full, WRED avoids dropping large numbers of packets at once. Thus, WRED allows the transmission line to be fully used at all times. WRED also drops more packets from large users than small. Therefore, sources that generate the most traffic are more likely to be slowed down versus sources that generate little traffic.

You can enable WRED and configure the two thresholds for a drop-precedence assigned to every egress queues. The WRED's color drop precedence map is the same as tail-drop's. Each min-threshold represents where WRED starts to randomly drop packets. After min-threshold is exceeded, WRED randomly begins to drop packets assigned to this threshold. As the queue max-threshold is approached, WRED continues to drop packets randomly with the rate of drop-probability. When the max-threshold is reached, WRED drops all packets assigned to the threshold. By default, WRED is disabled.

Scheduling

Scheduling forwards conditions packets using combination of WDRR and SP. Every queue belongs to a class. The class range from 0 to 7, and 7 is the highest priority. Several queues can be in a same class, or non queue in some class. Packets are scheduled by SP between classes and WDRR between queues in a class.

- Strict Priority-Based (SP), in which any high-priority packets are first transmitted. Lower-priority packets are transmitted only when the higher-priority queues are empty. A problem may occur when too many lower-priority packets are not transmitted.
- Weighted Deficit Round Robin (WDRR), in which each queue is assigned a weight to control the number of packets relatively sent from each queue.

Class Map

A class map names and isolates specific traffic from other traffic. The class map defines the criteria used to match against a specific traffic flow to further classify it. The criteria can match several access groups defined by the ACL.

If there is more than one type of traffic to be classified, another class map can be created under a different name. After a packet is matched against the class-map criteria, it is further classified using a policy map.

Policy Map

A policy map specifies on which traffic class to act. This can be implemented as follows:

- Set a specific priority and color in the traffic class.
- Set a specific trust policy to map priority and color.
- Specify the traffic bandwidth limitations for each matched traffic class (policer) and the action to take (marking) when the traffic is out of profile.
- Redirect the matched traffic class to a specific physical interface.
- Mirror the matched traffic class to a specific monitor session, which's destination is defined in mirror module(please refer to the "monitor session destination " command).
- Enable statistics of matching each ace or each class-map(if the class-map operator is match-any).
- Policy maps have the following attributes:
- A policy map can contain multiple class statements, each with different match criteria and action.
- A separate policy-map class can exist for each type of traffic received through an interface.

- There can be only one policy map per interface per direction. The same policy map can be applied to multiple interfaces and directions.
- Before a policy map can be effective, it must be attached to an interface.
- A policy map can be applied on physical interface(not link agg member), link agg interface, or vlan interface.

Mapping Tables

During QoS processing, the switch represents the priority of all traffic (including non-IP traffic) with an internal priority value:

- During classification, QoS uses configurable mapping tables to derive the internal priority (a 6-bit value) from received CoS, EXP(3-bit), DSCP or IP precedence (3-bit) values. These maps include the CoS-to-priority-color/COS-to-PHB map, EXP-to-priority-color/EXP-to-PHB map, DSCP-to-priority-color/DSCP-to-PHB map and the IP-precedence-to- priority-color/IP-PREC-to-PHB map.
- During policing, QoS can assign another priority and color to an IP or non-IP packet (if the packet matches the class-map). This configurable map is called the policed-priority-color map.
- Before the traffic reaches the scheduling stage, and replace CoS or DSCP is set, QoS uses the configurable priority-color-to-CoS or priority-color-to-DSCP map to derive a CoS or DSCP value from the internal priority color.
- Each QoS domain has an independent set of map tables mentioned above.

Time-range

By using time-range, the aces in the class-map can be applied based on the time of day or week. First, define a time-range name and set the times and the dates or the days of the week in the time range. Then enter the time-range name when adding an ace. You can use the time-range to define when the aces in the class-map are in effect, for example, during a specified time period or on specified days of the week.

These are some of the many possible benefits of using time-range:

- You can control over permitting or denying a user access to resources, such as an application, which is identified by an IP address and a port number.
- You can obtain the traffic statistics during appointed time.

- You can define when the action of a traffic class is in effect.

SRTCM

Single Rate Three Color Marker

TRTCM

Two Rate Three Color Marker

CIR

Committed Information Rate

CBS

Committed Burst Size

EIR

Excess Information Rate

EBS

Excess Burst Size

PIR

Peak Information Rate

PBS

Peak Burst Size

Modular QoS CLI

Input traffic is classified to a specified traffic class. All qos policies are attached to this traffic class.

class-map type qos

Type qos of class-map is used to identify traffic. The identification rules can be CoS/DSCP/IP Precedence/EXP/ACL.

policy-map type qos

Type qos of policy-map is used to assign traffic class. Type qos of class-map is referred by same type of policy-map.

class-map type traffic-class

Type traffic-class of class-map is used to identify traffic class. The identification rules is traffic class value.

policy-map type traffic-class

Type traffic-class of policy-map is used to specify qos policies. Type traffic-class of class-map is referred by same type of policy-map.

10.1.2 Configuration

The following provides information to consider before configuring QoS:

- QoS policing cannot be configured on Linkagg interface.
- Traffic can be only classified per ingress port.
- There can be multiple ACLs per class map. An ACL can have multiple access control entries that match fields against the packet contents.
- Policing cannot be done at the switch virtual interface level.

To configure a QoS policy, the following is usually required:

- Categorize traffic into classes.
- Configure policies to apply to the traffic classes.
- Attach policies to interfaces.

Classify Traffic Using ACLs

IP traffic can be classified using IP ACLs. The following shows creating an IP ACL for IP traffic. Follow these steps from Privileged Exec mode.

- configure terminal.
- ip access-list ACCESS-LIST-NAME. ACCESS-LIST-NAME = name of IP ACL
- create ACEs, Repeat this step as needed. For detail, please refer to ACL configuration Guide

The no ip access-list command deletes an access list.

The following example shows allowing access only for hosts on three specified networks. Wildcard bits correspond to the network address host portions. If a host has a source address that does not match the access list statements, it is rejected.

step 1 Enter the configure mode

```
Switch# configure terminal
```

step 2 Create ACL and ACEs

```
Switch(config)# ip access-list ip-acl
Switch(config-ip-acl)# permit any 128.88.12.0 0.0.0.255 any
Switch(config-ip-acl)# permit any 28.88.0.0 0.0.255.255 any
Switch(config-ip-acl)# permit any 11.0.0.0 0.255.255.255 any
Switch(config-ip-acl)# exit
```



NOTE Use the “no ip access-list” in global configure mode to remove the ACL. Use the “no sequence-num” in ACL configure mode to remove the ACE.

Terminology:

- ACL: Access Control List
- ACE: Access Control Entry

step 3 Exit the configure mode

```
Switch(config)# end
```

step 4 Validation

```
Switch# show access-list ip ip-acl
ip access-list ip-acl
 10 permit any 128.88.12.0 0.0.0.255 any
 20 permit any 28.88.0.0 0.0.255.255 any
 30 permit any 11.0.0.0 0.255.255.255 any
```

Create class-map

The following shows classifying IP traffic on a physical-port basis using class maps. This involves creating a class map, and defining the match criterion. In this case it is configuring a class map named cmap1 with 1 match criterion: IP access list ip-acl, which allows traffic from any source to any destination.

step 1 Enter the configure mode

```
Switch# configure terminal
```

step 2 Create ACL and ACEs

```
Switch(config)# ip access-list ip-acl
Switch(config-ip-acl)# permit any any any
Switch(config-ip-acl)# quit
```

step 3 Create class-map and match the ACL

```
Switch(config)# class-map cmap1
Switch (config-cmap)# match access-group ip-acl
Switch (config-cmap)# quit
```



NOTE

- match-any keyword to perform a logical-OR of all matching statements under this class map. One or more match criteria must be matched. match-any any is the default mode.
- match-all = Use the match-all keyword to perform a logical-AND of all matching statements under this class map. All match criteria in the class map must be matched.

step 4 Exit the configure mode

```
Switch(config)# end
```

step 5 Validation

```
Switch# show class-map cmap1
  CLASS-MAP-NAME: cmap1 (match-any)
    match access-group: ip-acl
```

Create Policy Map

The following shows creating a policy map to classify, policer, and mark traffic. In this example it is creating a policy map, and attaching it to an ingress interface. In this example, the IP ACL allows traffic from network 10.1.0.0. If the matched traffic exceeds a 48000-kbps average traffic rate, it is dropped.

step 1 Enter the configure mode

```
Switch# configure terminal
```

step 2 Create ACL and ACEs

```
Switch(config)# ip access-list ip-acl
Switch(config-ip-acl)# permit any 10.1.0.0 0.0.255.255 any
Switch(config-ip-acl)# quit
```

step 3 Create class-map and match the ACL

```
Switch(config)# class-map type qos cmap1
Switch(config-cmap)# match access-group ip-acl
Switch(config-cmap)# quit
```

step 4 Create policy-map and match the class-map; set the action in policy-class configure mode

```
switch(config)# policy-map type qos pmap1
switch(config-pmap)# class type qos cmap1
Switch(config-pmap-c)# policer color-blind cir 48000 cbs 10000 ebs 16000 violate
drop
Switch(config-pmap-qos-c)# set traffic-class 5
Switch(config-pmap-qos-c)# set color yellow
Switch(config-pmap-c)# quit
Switch(config-pmap)# quit
```



NOTE

Use the “no policy-map” in global configure mode to remove the policy-map. Use the “no policer” in policy-class configure mode to remove the policer, Use the “no set” in policy-class configure mode to reset the default value for priority or color. (By default the priority is 0 and color is green.)

step 5 Enter the interface configure mode and apply the policy-map

```
Switch(config)# interface eth-0-1
Switch(config-if)# service-policy type qos input pmap1
Switch(config-if)# exit
```



NOTE Currently only one policy-map is supported per-direction for each interface. The "no service-policy input|output" command is used to unapply the policy map.

step 6 Exit the configure mode

```
Switch(config)# end
```

step 7 Validation

```
Switch# show policy-map pmap1

POLICY-MAP-NAME: pmap1 ( type qos)
  State: detached

  CLASS-MAP-NAME: cmap1
    match access-group: ip-acl
      set traffic-class      : 5
      set color              : yellow
    policer color-blind cir 48000 cbs 10000 ebs 16000 violate drop
```

Create Aggregate Policer

The following shows creating an aggregate policer to classify, police, and mark traffic. In this example it is creating an aggregate policer, and attaching it to multiple classes within a policy map. In this example, the IP ACLs allow traffic from network 10.1.0.0 and host 11.3.1.1. The traffic rate from network 10.1.0.0 and host 11.3.1.1 is policed. If the traffic exceeds a 48000-kbps average traffic rate and an 8000-byte normal burst size, it is considered out of profile, and is dropped. The policy map is attached to an ingress interface.

step 1 Enter the configure mode

```
Switch# configure terminal
```

step 2 Create ACL and ACEs

```
Switch(config)# ip access-list ip-acl1
Switch(config-ip-acl)# permit any 10.1.0.0 0.0.255.255 any
Switch(config-ip-acl)# exit
Switch(config)# ip access-list ip-acl2
Switch(config-ip-acl)# permit any host 11.3.1.1 any
Switch(config-ip-acl)# exit
```

step 3 Create an aggregate-policer

```
Switch(config)# qos aggregate-policer transmit1 color-blind cir 48000 cbs 8000 ebs
10000 violate drop
```



NOTE

To delete the aggregate-policer, use the "no qos aggregate-policer" command.

step 4 Create class-map and match the ACL

```
Switch(config)# class-map type qos cmap1
Switch(config-cmap)# match access-group ip-acl1
Switch(config-cmap)# exit
Switch(config)# class-map type qos cmap2
Switch(config-cmap)# match access-group ip-acl2
Switch(config-cmap)# exit
```

step 5 Create policy-map and match the class-map; Apply the aggregate-policer in policy-class configure mode

```
Switch(config)# policy-map type qos aggflow1
Switch(config-pmap)# class type qos cmap1
Switch(config-pmap-c)# aggregate-policer transmit1
Switch(config-pmap-c)# exit
Switch(config-pmap)# class type qos cmap2
Switch(config-pmap-c)# aggregate-policer transmit1
Switch(config-pmap-c)# exit
Switch(config-pmap)# exit
```



NOTE

To remove the aggregate-policer, use the "no policer-aggregate" command in in policy-class configure mode.

step 6 Enter the interface configure mode and apply the policy-map

```
Switch(config)# interface eth-0-1
Switch(config-if)# service-policy type qos input aggflow1
Switch(config-if)# exit
Switch(config)# exit
```

step 7 Exit the configure mode

```
Switch(config)# end
```

step 8 Validation

```
Switch# show qos aggregate-policer
Aggregate policer: transmit1
  color blind
  CIR 48000 kbps, CBS 8000 bytes, EBS 10000 bytes
  drop violate packets
```

10.1.3 Configuration for Queue

Configuring Schedule

Packets are scheduled by SP between different classes and WRR between queues in the same class.

The following example shows configuring schedule parameters for egress queues. In this example, traffic 5 and 6 belongs to class 6, which is highest priority. Traffic 2 belongs class 0, the bandwidth is 20%.

step 1 Enter the configure mod

```
Switch# configure terminal
```

step 2 Create class-map and match the traffic-class

```
Switch(config)# class-map type traffic-class tc5
Switch(config-cmap-tc)# match traffic-class 5
Switch(config-cmap-tc)# exit

Switch(config)# class-map type traffic-class tc6
Switch(config-cmap-tc)# match traffic-class 6
Switch(config-cmap-tc)# exit

Switch(config)# class-map type traffic-class tc2
Switch(config-cmap-tc)# match traffic-class 2
Switch(config-cmap-tc)# exit
```

step 3 Create policy-map and match the class-map ; Set the priority in policy-class configure mode

```
Switch(config)# policy-map type traffic-class tc
Switch(config-pmap-tc)# class type traffic-class tc5
```

```
Switch(config-pmap-tc-c)# priority level 6
Switch(config-pmap-tc-c)# exit

Switch(config-pmap-tc)# class type traffic-class tc6
Switch(config-pmap-tc-c)# priority level 6
Switch(config-pmap-tc-c)# exit

Switch(config-pmap-tc)# class type traffic-class tc2
Switch(config-pmap-tc-c)# bandwidth percentage 20
Switch(config-pmap-tc-c)# exit
Switch(config-pmap-tc)# exit
```

step 4 Enter the interface configure mode and apply the policy-map

```
Switch(config)# interface eth-0-1
Switch(config-if)# service-policy type traffic-class tc
Switch(config-if)# exit
```

step 5 Exit the configure mode

```
Switch(config)# end
```

step 6 Validation

```
Switch# show qos interface eth-0-1 egress
```

TC	Priority	Bandwidth	Shaping (kbps)	Drop-Mode	Max-Queue-Limit (Cell)	ECN
0	0	-	-	dynamic	level 10	-
1	0	-	-	random-drop	596	Disable
2	0	20	-	dynamic	level 10	-
3	0	-	-	tail-drop	2000	2000
4	0	-	-	dynamic	level 10	-
5	6	-	-	dynamic	level 10	-
6	6	-	-	dynamic	level 10	-
7	7	-	-	tail-drop	64	-

Configuring Tail Drop

Tail drop is the default congestion-avoidance technique on every egress queue. With tail drop, packets are queued until the thresholds are exceeded. The following shows configuring tail drop threshold for different drop-precedence. Follow these steps from Privileged Exec mode.

In this example it is configuring tail drop threshold for traffic class 3. In this example, packet drop threshold is 2000.

step 1 Enter the configure mode

```
Switch# configure terminal
```

step 2 Create class-map and match the traffic-class

```
Switch(config)# class-map type traffic-class tc3
Switch(config-cmap-tc)# match traffic-class 3
Switch(config-cmap-tc)# exit
```

step 3 Create policy-map and match the class-map

```
Switch(config)# policy-map type traffic-class tc
Switch(config-pmap-tc)# class type traffic-class tc3
```

step 4 Set the threshold for tail drop in policy-class configure mode

```
Switch(config-pmap-tc-c)# queue-limit 2000
Switch(config-pmap-tc-c)# exit
Switch(config-pmap-tc)# exit
```

step 5 Enter the interface configure mode and apply the policy-map

```
Switch(config)# interface eth-0-1
Switch(config-if)# service-policy type traffic-class tc
Switch(config-if)# exit
```

step 6 Exit the configure mode

```
Switch(config)# end
```

step 7 Validation

```
Switch# show qos interface eth-0-1 egress
```

TC	Priority	Bandwidth	Shaping(kbps)	Drop-Mode	Max-Queue-Limit(Cell)	ECN
0	0	-	-	dynamic	level 10	-
1	0	-	-	dynamic	level 10	-
2	0	-	-	dynamic	level 10	-
3	0	-	-	tail-drop	2000	2000
4	0	-	-	dynamic	level 10	-
5	0	-	-	dynamic	level 10	-
6	0	-	-	dynamic	level 10	-
7	7	-	-	tail-drop	64	-

Configuring WRED

WRED reduces the chances of tail drop by selectively dropping packets when the output interface detects congestion. By dropping some packets early rather than waiting until the queue is full, WRED avoids TCP synchronization dropping and thereafter improves the overall network throughput.

The following example shows configuring WRED threshold for traffic class 1. In this example, the max-threshold is 596, min-threshold is $596/8=71$. If buffered packets exceed min-threshold, the subsequent packet will be dropped randomly.

step 1 Enter the configure mode

```
Switch# configure terminal
```

step 2 Create class-map and match the traffic-class

```
Switch(config)# class-map type traffic-class tc1
Switch(config-cmap-tc)# match traffic-class 1
Switch(config-cmap-tc)# exit
```

step 3 Create policy-map and match the class-map

```
Switch(config)# policy-map type traffic-class tc
Switch(config-pmap-tc)# class type traffic-class tc1
```

step 4 Set the threshold for WRED in policy-class configure mode

```
Switch(config-pmap-tc-c)# random-detect maximum-threshold 596
Switch(config-pmap-tc-c)# exit
Switch(config-pmap-tc)# exit
```

step 5 Enter the interface configure mode and apply the policy-map

```
Switch(config)# interface eth-0-1
Switch(config-if)# service-policy type traffic-class tc
Switch(config-if)# exit
```

step 6 Exit the configure mode

```
Switch(config)# end
```

step 7 Validation

```
Switch# show qos interface eth-0-1 egress
```

TC	Priority	Bandwidth	Shaping(kbps)	Drop-Mode	Max-Queue-Limit(Cell)	ECN
0	0	-	-	dynamic	level 10	-
1	0	-	-	random-drop	596	Disable
2	0	-	-	dynamic	level 10	-
3	0	-	-	tail-drop	2000	2000
4	0	-	-	dynamic	level 10	-
5	0	-	-	dynamic	level 10	-
6	0	-	-	dynamic	level 10	-
7	7	-	-	tail-drop	64	-

Queue shaping

All the traffic in the egress queue can be shaped, and all the exceeding traffic will be buffered. If no buffer, it is dropped.

The following example shows creating a queue shaping for queue 3. In this example, if the traffic in queue 3 exceeds 1000Mbps, it is buffered.

step 1 Enter the configure mode

```
Switch# configure terminal
```

step 2 Create class-map and match the traffic-class

```
Switch(config)# class-map type traffic-class tc3  
Switch(config-cmap-tc)# match traffic-class 3  
Switch(config-cmap-tc)# exit
```

step 3 Create policy-map and match the class-map

```
Switch(config)# policy-map type traffic-class tc  
Switch(config-pmap-tc)# class type traffic-class tc3
```

step 4 Set the shape rate in policy-class configure mode

```
Switch(config-pmap-tc-c)# shape rate pir 1000000  
Switch(config-pmap-tc-c)# exit  
Switch(config-pmap-tc)# exit
```



NOTE

Use the "no shape rate" command to unset the shape rate.

step 5 Enter the interface configure mode and apply the policy-map

```
Switch(config)# interface eth-0-1  
Switch(config-if)# service-policy type traffic-class tc  
Switch(config-if)# exit
```

step 6 Exit the configure mode

```
Switch(config)# end
```

step 7 Validation

```
Switch# show qos interface eth-0-1 egress  
TC Priority Bandwidth Shaping (kbps) Drop-Mode Max-Queue-Limit(Cell) ECN
```

0	0	-	-	dynamic	level 10	-
1	0	-	-	random-drop	596	Disable
2	0	20	-	dynamic	level 10	-
3	0	-	1000000	tail-drop	2000	2000
4	0	-	-	dynamic	level 10	-
5	6	-	-	dynamic	level 10	-
6	6	-	-	dynamic	level 10	-
7	7	-	-	tail-drop	64	-

10.1.4 Configuration for Port shaping & port policing

Configuring Port policing

All traffic received or transmitted in the physical interface can be limited rate, and all the exceeding traffic will be dropped.

The following example shows creating an ingress port policer. In this example, if the received traffic exceeds a 48000-kbps average traffic rate, it is dropped.

step 1 Enter the configure mode

```
Switch# configure terminal
```

step 2 Enter the interface configure mode and set the policer rate

```
Switch(config)# interface eth-0-1
Switch(config-if)# qos policer input color-blind cir 48000 cbs 10000 ebs 20000
violate drop
Switch(config-if)# exit
```



NOTE To remove the configuration of policer, use the "no port-policier input|output" command.

step 3 Exit the configure mode

```
Switch(config)# end
```

step 4 Validation

```
Switch# show qos interface eth-0-1 statistics policer port input
Interface: eth-0-1
input port policer:
color blind
CIR 48000 kbps, CBS 10000 bytes, EBS 20000 bytes
drop violate packets
```

Configuring Port shaping

All traffic transmitted in the physical interface can be shaped, and all the exceeding traffic will be buffered. If no buffer, it is dropped.

The following example shows creating a port shaping. In this example, if the received traffic exceeds a 1000Mbps, it is buffered.

step 1 Enter the configure mode

```
Switch# configure terminal
```

step 2 Enter the interface configure mode and set the shape rate

```
Switch(config)# interface eth-0-1
Switch(config-if)# qos shape rate pir 1000000
Switch(config-if)# exit
```



NOTE

To remove the configuration of shape, use the "no shape" command.

step 3 Exit the configure mode

```
Switch(config)# end
```

step 4 Validation

```
Switch# show running-config interface eth-0-1
Building configuration...
!
interface eth-0-1
 service-policy type traffic-class tc
 qos policer input color-blind cir 48000 cbs 10000 ebs 20000 violate drop
 qos shape rate pir 1000000
!
```

10.1.5 Application cases

N/A

11 IPv6 Service Configuration

11.1 Configuring IPv6 over IPv4 Tunnel

11.1.1 Overview

Function Introduction

Tunneling is an encapsulation technology, which uses one network protocol to encapsulate packets of another network protocol and transfer them over a virtual point-to-point connection. The virtual connection is called a tunnel. Tunneling refers to the whole process from data encapsulation to data transfer and data decapsulation.

Principle Description

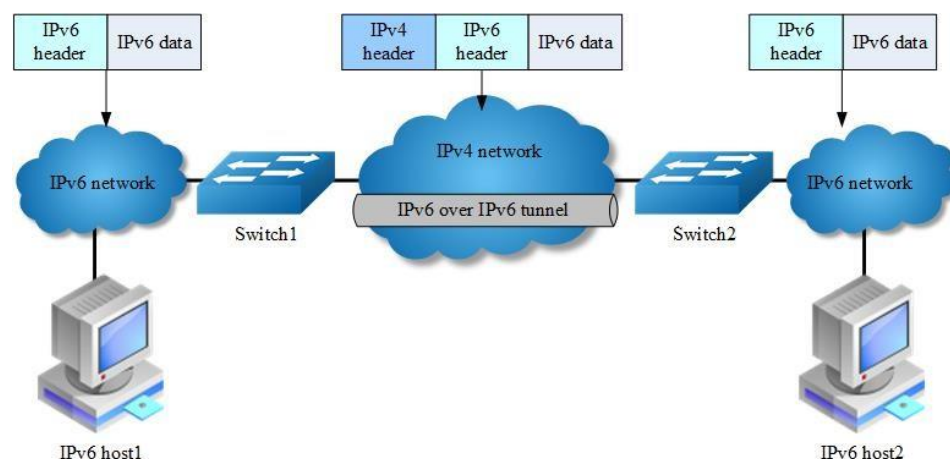

Figure 11-1 IPv6 over IPv4 Tunnel

Overlay tunneling encapsulates IPv6 packets in IPv4 packets for delivery across an IPv4 infrastructure (a core network or the Internet). By using overlay tunnels, you can communicate with isolated IPv6 networks without upgrading the IPv4 infrastructure between them. Overlay tunnels can be configured between border routers or between a border router and a host; however, both tunnel endpoints must support

both the IPv4 and IPv6 protocol stacks. The IPv6 over IPv4 tunnel processes packets in the following ways:

- A host in the IPv6 network sends an IPv6 packet to Switch1 at the tunnel source.
- After determining according to the routing table that the packet needs to be forwarded through the tunnel, Switch1 encapsulates the IPv6 packet with an IPv4 header and forwards it through the physical interface of the tunnel.
- Upon receiving the packet, Switch2 decapsulates the packet.
- Switch2 forwards the packet according to the destination address in the de-encapsulated IPv6 packet. If the destination address is the device itself, Switch2 forwards the IPv6 packet to the upper-layer protocol for processing.

The benefit of the technique is that current ipv4 networks do not need to update on all nodes. Only the edge nodes are required to support dual stack and tunnel.

IPv6 over IPv4 tunnels are divided into manually configured tunnels and automatic tunnels, depending on how the IPv4 address of the tunnel destination is acquired:

- Manually configured tunnel: The destination address of the tunnel cannot be automatically acquired through the destination IPv6 address of an IPv6 packet at the tunnel source, and must be manually configured.
- Automatic tunnel: The destination address of the tunnel is an IPv6 address with an IPv4 address embedded, and the IPv4 address can be automatically acquired through the destination IPv6 address of an IPv6 packet at the tunnel source.

Normally, system supports the following types of overlay tunneling mechanisms:

- Manual
- 6to4
- Intra-site Automatic Tunnel Addressing Protocol (ISATAP)

The details of the 3 types of overlay tunneling mechanisms are described below:

Manual Tunnel

A manually configured tunnel is equivalent to a permanent link between two IPv6 domains over an IPv4 backbone. The primary use is for stable connections that

require regular secure communication between two edge routers or between an end system and an edge router, or for connection to remote IPv6 networks.

An IPv6 address is manually configured on a tunnel interface, and manually configured IPv4 addresses are assigned to the tunnel source and the tunnel destination. The host or router at each end of a configured tunnel must support both the IPv4 and IPv6 protocol stacks. Manually configured tunnels can be configured between border routers or between a border router and a host.

6to4 Tunnel

Ordinary 6to4 tunnel

- An automatic 6to4 tunnel allows isolated IPv6 domains to be connected over an IPv4 network to remote IPv6 networks. The key difference between automatic 6to4 tunnels and manually configured tunnels is that the tunnel is not point-to-point; it is point-to-multipoint. In automatic 6to4 tunnels, routers are not configured in pairs because they treat the IPv4 infrastructure as a virtual non-broadcast multi-access (NBMA) link. The IPv4 address embedded in the IPv6 address is used to find the other end of the automatic tunnel.
- An automatic 6to4 tunnel may be configured on a border router in an isolated IPv6 network, which creates a tunnel on a per-packet basis to a border router in another IPv6 network over an IPv4 infrastructure. The tunnel destination is determined by the IPv4 address of the border router extracted from the IPv6 address that starts with the prefix 2002::/16, where the format is 2002:router-IPv4-address::/48.
- Following the embedded IPv4 address are 16 bits that can be used to number networks within the site. The border router at each end of a 6to4 tunnel must support both the IPv4 and IPv6 protocol stacks. 6to4 tunnels are configured between border routers or between a border router and a host.

6to4 relay

A 6to4 tunnel is only used to connect 6to4 networks, whose IP prefix must be 2002::/16. However, IPv6 network addresses with the prefix such as 2001::/16 may also be used in IPv6 networks. To connect a 6to4 network to an IPv6 network, a 6to4 router must be used as a gateway to forward packets to the IPv6 network. Such a router is called 6to4 relay router.

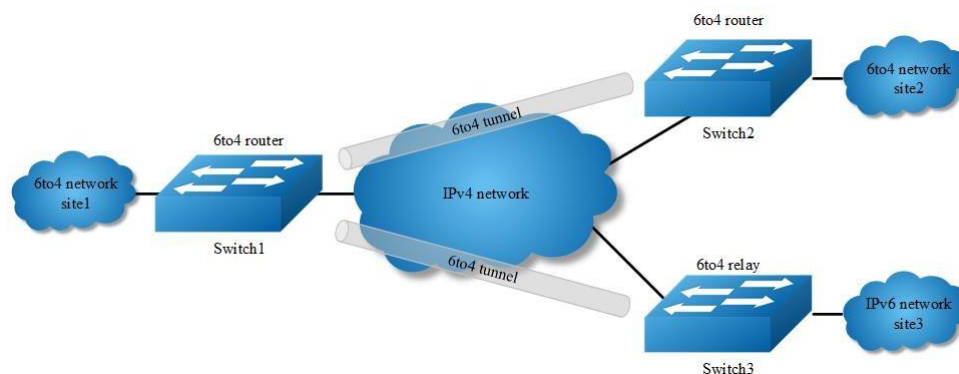

Figure 11-2 IPv6 over IPv4 Tunnel

As shown in the above figure, a static route must be configured on the border router (Switch1) in the 6to4 network and the next-hop address must be the 6to4 address of the 6to4 relay router (Switch3). In this way, all packets destined for the IPv6 network will be forwarded to the 6to4 relay router, and then to the IPv6 network. Thus, interworking between the 6to4 network (with the address prefix starting with 2002) and the IPv6 network is realized.

ISATAP Tunnel

ISATAP is an automatic overlay tunneling mechanism that uses the underlying IPv4 network as a NBMA link layer for IPv6. ISATAP is designed for transporting IPv6 packets within a site where a native IPv6 infrastructure is not yet available; for example, when sparse IPv6 hosts are deployed for testing. ISATAP tunnels allow individual IPv4 or IPv6 dual-stack hosts within a site to communicate with other such hosts on the same virtual link, basically creating an IPv6 network using the IPv4 infrastructure.

When an ISATAP tunnel is used, the destination address of an IPv6 packet and the IPv6 address of a tunnel interface both adopt special ISATAP addresses. ISATAP uses a well-defined IPv6 address format composed of any unicast IPv6 prefix (/64), which can be link local, or global (including 6to4 prefixes), enabling IPv6 routing locally or on the Internet. The IPv4 address is encoded in the last 32 bits of the IPv6 address, enabling automatic IPv6-in-IPv4 tunneling. The ISATAP address format is `prefix(64bit):0:5EFE: IPv4-address`.

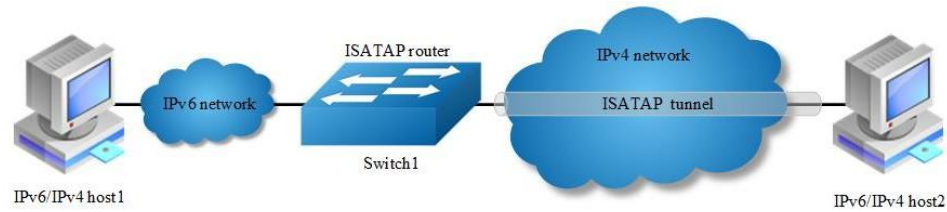

Figure 11-3 ISATAP Tunnel

The ISATAP router provides standard router advertisement network configuration support for the ISATAP site. This feature allows clients to automatically configure themselves as they would do if they were connected to an Ethernet. It can also be configured to provide connectivity out of the site.

Although the ISATAP tunneling mechanism is similar to other automatic tunneling mechanisms, such as IPv6 6to4 tunneling, ISATAP is designed for transporting IPv6 packets within a site, not between sites.

11.1.2 Configuration

Configure Manual Tunnel

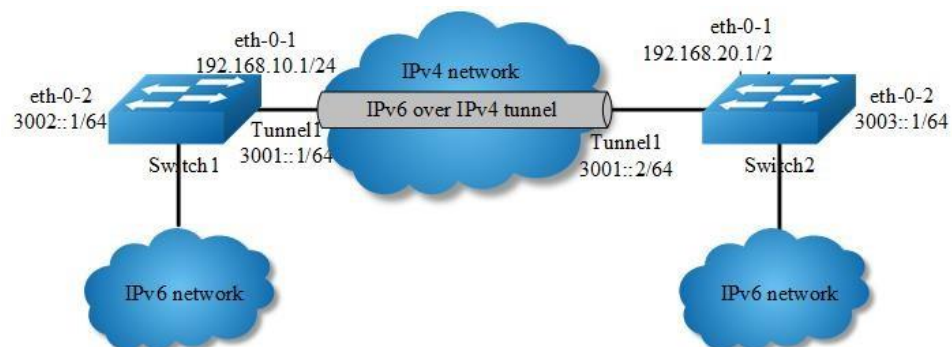

Figure 11-4 Manual Tunnel

As shown in the above Figure, two IPv6 networks are connected over an IPv4 network. Configure an IPv6 manual tunnel between Switch1 and Switch2 to make the two IPv6 networks reachable to each other.

NOTE

- Must enable IPv6/IPv4 dual stack before tunnel configuration.
- Make sure tunnel destination is reachable in the IPv4 network.

- There must exist an IPv6 address in the tunnel interface, otherwise routes with tunnel interface as nexthop will be invalid.

The following configuration should be operated on all switches if the switch ID is not specified.

step 1 Enter the configure mode

```
Switch# configure terminal
```

step 2 Enable ipv6 globally

```
Switch(config)# ipv6 enable
```

step 3 Enter the interface configure mode and set the attributes of the interface

Interface configuration for Switch1:

```
Switch(config)# interface eth-0-1
Switch(config-if)# no switchport
Switch(config-if)# ip address 192.168.10.1/24
Switch(config-if)# tunnel enable
Switch(config-if)# no shutdown
Switch(config-if)# exit

Switch(config)# interface eth-0-2
Switch(config-if)# no switchport
Switch(config-if)# ipv6 address 3002::1/64
Switch(config-if)# no shutdown
Switch(config-if)# exit

Switch(config)# interface tunnel1
Switch(config-if)# tunnel source eth-0-1
Switch(config-if)# tunnel destination 192.168.20.1
Switch(config-if)# tunnel mode ipv6ip
Switch(config-if)# ipv6 address 3001::1/64
Switch(config-if)# exit
```

Interface configuration for Switch2:

```
Switch(config)# interface eth-0-1
Switch(config-if)# no switchport
Switch(config-if)# ip address 192.168.20.1/24
Switch(config-if)# tunnel enable
Switch(config-if)# no shutdown
Switch(config-if)# exit

Switch(config)# interface eth-0-2
Switch(config-if)# no switchport
Switch(config-if)# ipv6 address 3003::1/64
Switch(config-if)# no shutdown
```

```
Switch(config-if)# exit

Switch(config)# interface tunnel1
Switch(config-if)# tunnel source eth-0-1
Switch(config-if)# tunnel destination 192.168.10.1
Switch(config-if)# tunnel mode ipv6ip
Switch(config-if)# ipv6 address 3001::2/64
Switch(config-if)# exit
```

step 4 Create static routes

Configuring Switch1:

```
Switch(config)# ip route 192.168.20.0/24 192.168.10.2
Switch(config)# ipv6 route 3003::/16 tunnel1
```

Configuring Switch2:

```
Switch(config)# ip route 192.168.10.0/24 192.168.20.2
Switch(config)# ipv6 route 3002::/16 tunnel1
```

step 5 Configuring static arp

Configuring Switch1:

```
Switch(config)# arp 192.168.10.2 0.0.2222
```

Configuring Switch2:

```
Switch(config)# arp 192.168.20.2 0.0.1111
```

step 6 Exit the configure mode

```
Switch(config)# end
```

step 7 Validation

Display the result on Switch1:

```
Switch# show interface tunnel1
Interface tunnel1
  Interface current state: UP
  Hardware is Tunnel
  Index 8193 , Metric 1 , Encapsulation TUNNEL
  VRF binding: not bound
  Tunnel protocol/transport IPv6/IP, Status Valid
  Tunnel source 192.168.10.1(eth-0-1), destination 192.168.20.1
  Tunnel DSCP inherit, Tunnel TTL 64
  Tunnel transport MTU 1480 bytes

Switch1# show ipv6 interface tunnel1
```

```
Interface current state: UP
The maximum transmit unit is 1480 bytes
IPv6 is enabled, link-local address is fe80::c0a8:a01
Global unicast address(es):
  3001::1, subnet is 3001::/64
ICMP error messages limited to one every 1000 milliseconds
ICMP redirects are always sent
ND DAD is enabled, number of DAD attempts: 1
ND router advertisement is disabled
ND reachable time is 30000 milliseconds
ND advertised reachable time is 0 milliseconds
ND retransmit interval is 1000 milliseconds
ND advertised retransmit interval is 0 milliseconds
ND router advertisements max interval: 600 secs
ND router advertisements min interval: 198 secs
ND router advertisements live for 1800 seconds
ND router advertisements hop-limit is 0
Hosts use stateless autoconfig for addresses.
```

Display the result on Switch2:

```
Switch# show interface tunnell
Interface tunnell
  Interface current state: UP
  Hardware is Tunnel
  Index 8193 , Metric 1 , Encapsulation TUNNEL
  VRF binding: not bound
  Tunnel protocol/transport IPv6/IP, Status Valid
  Tunnel source 192.168.20.1(eth-0-1), destination 192.168.10.1
  Tunnel DSCP inherit, Tunnel TTL 64
  Tunnel transport MTU 1480 bytes
Switch1# show ipv6 interface tunnell
Interface current state: UP
The maximum transmit unit is 1480 bytes
IPv6 is enabled, link-local address is fe80::c0a8:1401
Global unicast address(es):
  3001::2, subnet is 3001::/64
ICMP error messages limited to one every 1000 milliseconds
ICMP redirects are always sent
ND DAD is enabled, number of DAD attempts: 1
ND router advertisement is disabled
ND reachable time is 30000 milliseconds
ND advertised reachable time is 0 milliseconds
ND retransmit interval is 1000 milliseconds
ND advertised retransmit interval is 0 milliseconds
ND router advertisements max interval: 600 secs
ND router advertisements min interval: 198 secs
ND router advertisements live for 1800 seconds
ND router advertisements hop-limit is 0
Hosts use stateless autoconfig for addresses.
```

Configure 6to4 Tunnel

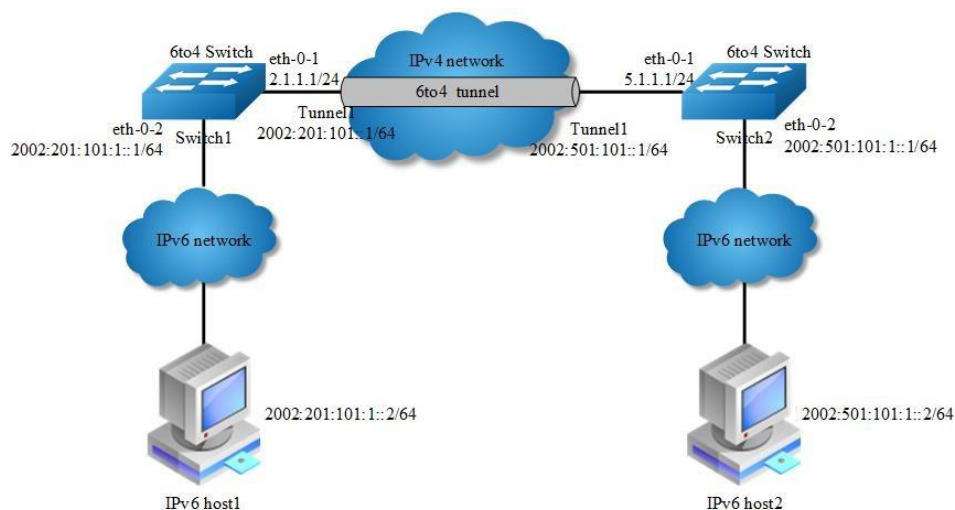

Figure 11-5 6to4 tunnel

As shown in the above Figure, two 6to4 networks are connected to an IPv4 network through two 6to4 routers (Switch1 and Switch2) respectively. Configure a 6to4 tunnel to make Host1 and Host2 reachable to each other.

To enable communication between 6to4 networks, you need to configure 6to4 addresses for 6to4 routers and hosts in the 6to4 networks.

The IPv4 address of eth-0-1 on Switch1 is 2.1.1.1/24, and the corresponding 6to4 prefix is 2002:0201:0101::/48 after it is translated to an IPv6 address. Assign interface tunnel 1 to subnet 2002:0201:0101::/64 and eth-0-2 to subnet 2002:0201:0101:1::/64.

The IPv4 address of eth-0-1 on Switch2 is 5.1.1.1/24, and the corresponding 6to4 prefix is 2002:0501:0101::/48 after it is translated to an IPv6 address. Assign interface tunnel 1 to subnet 2002:0501:0101::/64 and eth-0-2 to subnet 2002:0501:0101:1::/64.

NOTE

- No destination address needs to be configured for a 6to4 tunnel
- The automatic tunnel interfaces using the same encapsulation protocol cannot share the same source IP address
- To encapsulate and forward IPv6 packets whose destination address does not belong to the network segment where the receiving tunnel interface resides,

you need to configure a static route to reach the destination IPv6 address through this tunnel interface on the router. Because automatic tunnels do not support dynamic routing, you can configure a static route to that destination IPv6 address with this tunnel interface as the outbound interface or the peer tunnel interface address as the next hop

- Only on4 6to4 tunnel can exist in the same node.

The following configuration should be operated on all switches if the switch ID is not specified.

step 1 Enter the configure mode

```
Switch# configure terminal
```

step 2 Enable ipv6 globally

```
Switch(config)# ipv6 enable
```

step 3 Enter the interface configure mode and set the attributes of the interface

Interface configuration for Switch1:

```
Switch(config)# interface eth-0-1
Switch(config-if)# no switchport
Switch(config-if)# ip address 2.1.1.1/24
Switch(config-if)# tunnel enable
Switch(config-if)# no shutdown
Switch(config-if)# exit

Switch(config)# interface eth-0-2
Switch(config-if)# no switchport
Switch(config-if)# ipv6 address 2002:201:101:1::1/64
Switch(config-if)# no shutdown
Switch(config-if)# exit

Switch(config)# interface tunnel1
Switch(config-if)# tunnel source eth-0-1
Switch(config-if)# tunnel mode ipv6ip 6to4
Switch(config-if)# ipv6 address 2002:201:101::1/64
Switch(config-if)# exit
```

Interface configuration for Switch2:

```
Switch(config)# interface eth-0-1
Switch(config-if)# no switchport
Switch(config-if)# ip address 5.1.1.1/24
Switch(config-if)# tunnel enable
Switch(config-if)# no shutdown
```

```
Switch(config-if)# exit

Switch(config)# interface eth-0-2
Switch(config-if)# no switchport
Switch(config-if)# ipv6 address 2002:501:101:1::1/64
Switch(config-if)# no shutdown
Switch(config-if)# exit

Switch(config)# interface tunnel1
Switch(config-if)# tunnel source eth-0-1
Switch(config-if)# tunnel mode ipv6ip 6to4
Switch(config-if)# ipv6 address 2002:501:101::1/64
Switch(config-if)# exit
```

step 4 Create static routes

Configuring Switch1:

```
Switch(config)# ip route 5.1.1.0/24 2.1.1.2
Switch(config)# ipv6 route 2002::/16 tunnel1
```

Configuring Switch2:

```
Switch(config)# ip route 2.1.1.0/24 5.1.1.2
Switch(config)# ipv6 route 2002::/16 tunnel1
```

step 5 Configuring static arp

Configuring Switch1:

```
Switch(config)# arp 2.1.1.2 0.0.2222
```

Configuring Switch2:

```
Switch(config)# arp 5.1.1.2 0.0.1111
```

step 6 Exit the configure mode

```
Switch(config)# end
```

step 7 Validation

Display the result on Switch1:

```
Switch1# show interface tunnel1
Interface tunnel1
  Interface current state: UP
  Hardware is Tunnel
  Index 8193 , Metric 1 , Encapsulation TUNNEL
  VRF binding: not bound
  Tunnel protocol/transport IPv6/IP 6to4, Status Valid
```

```
Tunnel source 2.1.1.1(eth-0-1), destination UNKNOWN
Tunnel DSCP inherit, Tunnel TTL 64
Tunnel transport MTU 1480 bytes
```

Display the result on Switch2:

```
Switch2# show interface tunnel1
Interface tunnel1
  Interface current state: UP
  Hardware is Tunnel
  Index 8193 , Metric 1 , Encapsulation TUNNEL
  VRF binding: not bound
  Tunnel protocol/transport IPv6/IP 6to4, Status Valid
  Tunnel source 5.1.1.1(eth-0-1), destination UNKNOWN
  Tunnel DSCP inherit, Tunnel TTL 64
  Tunnel transport MTU 1480 bytes
```

Configure 6to4 relay

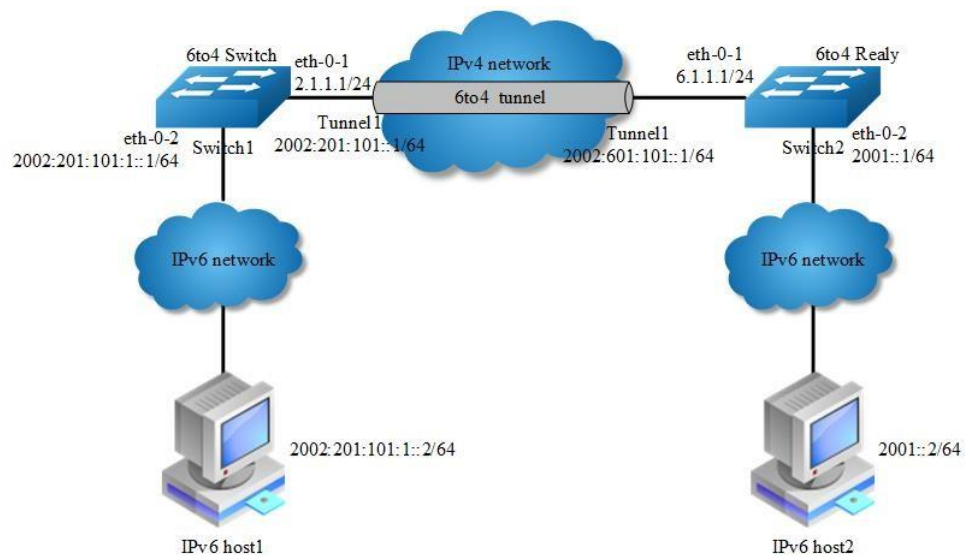

Figure 11-6 6to4 relay

As shown in the above Figure, Switch1 is a 6to4 router, and 6to4 addresses are used on the connected IPv6 network. Switch2 serves as a 6to4 relay router and is connected to the IPv6 network (2001::/16). Configure a 6to4 tunnel between Router A and Router B to make Host A and Host B reachable to each other.

NOTE

- The configuration on a 6to4 relay router is similar to that on a 6to4 router. However, to enable communication between the 6to4 network and the IPv6 network, you need to configure a route to the IPv6 network on the 6to4 router.

- It is not allowed to change the tunnel mode from 6to4 to ISATAP when there are any 6to4 relay routes existing. You must delete this route first.

The following configuration should be operated on all switches if the switch ID is not specified.

step 1 Enter the configure mode

```
Switch# configure terminal
```

step 2 Enable ipv6 globally

```
Switch(config)# ipv6 enable
```

step 3 Enter the interface configure mode and set the attributes of the interface

Interface configuration for Switch1:

```
Switch(config)# interface eth-0-1
Switch(config-if)# no switchport
Switch(config-if)# ip address 2.1.1.1/24
Switch(config-if)# tunnel enable
Switch(config-if)# no shutdown
Switch(config-if)# exit

Switch(config)# interface eth-0-2
Switch(config-if)# no switchport
Switch(config-if)# ipv6 address 2002:201:101:1::1/64
Switch(config-if)# no shutdown
Switch(config-if)# exit

Switch(config)# interface tunnel1
Switch(config-if)# tunnel source eth-0-1
Switch(config-if)# tunnel mode ipv6ip 6to4
Switch(config-if)# ipv6 address 2002:201:101::1/64
Switch(config-if)# exit
```

Interface configuration for Switch2:

```
Switch(config)# interface eth-0-1
Switch(config-if)# no switchport
Switch(config-if)# ip address 5.1.1.1/24
Switch(config-if)# tunnel enable
Switch(config-if)# no shutdown
Switch(config-if)# exit

Switch(config)# interface eth-0-2
Switch(config-if)# no switchport
Switch(config-if)# ipv6 address 2002:501:101:1::1/64
Switch(config-if)# no shutdown
Switch(config-if)# exit
```

```
Switch(config)# interface tunnel1
Switch(config-if)# tunnel source eth-0-1
Switch(config-if)# tunnel mode ipv6ip 6to4
Switch(config-if)# ipv6 address 2002:501:101::1/64
Switch(config-if)# exit
```

step 4 Create static routes

Configuring Switch1:

```
Switch(config)# ip route 6.1.1.0/24 2.1.1.2
Switch(config)# ipv6 route 2001::/16 2002:601:101::1
Switch(config)# ipv6 route 2002:601:101::/48 tunnel1
```

Configuring Switch2:

```
Switch(config)# ip route 2.1.1.0/24 6.1.1.2
Switch(config)# ipv6 route 2002::/16 tunnel1
```

step 5 Configuring static arp

Configuring Switch1:

```
Switch(config)# arp 2.1.1.2 0.0.2222
```

Configuring Switch2:

```
Switch(config)# arp 6.1.1.2 0.0.1111
```

step 6 Exit the configure mode

```
Switch(config)# end
```

step 7 Validation

Display the result on Switch1:

```
Switch# show interface tunnel1
Interface tunnel1
  Interface current state: UP
  Hardware is Tunnel
  Index 8193 , Metric 1 , Encapsulation TUNNEL
  VRF binding: not bound
  Tunnel protocol/transport IPv6/IP 6to4, Status Valid
  Tunnel source 2.1.1.1(eth-0-1), destination UNKNOWN
  Tunnel DSCP inherit, Tunnel TTL 64
  Tunnel transport MTU 1480 bytes

Switch# show ipv6 route
IPv6 Routing Table
```

```

Codes: C - connected, S - static, R - RIP, O - OSPF, I - IS-IS, B - BGP
      [*] - [AD/Metric]
Timers: Uptime

S      2001::/16 [1/0]
      via 2002:601:101::1 (recursive via ::, tunnel1), 00:00:32
C      2002:201:101::/64
      via ::, tunnel1, 00:00:04
C      2002:201:101::1/128
      via ::1, tunnel1, 00:00:04
S      2002:601:101::/48 [1/0]
      via ::, tunnel1, 00:00:22

```

```

Switch# show ipv6 interface tunnel1
Interface tunnel1
  Interface current state: UP
  The maximum transmit unit is 1480 bytes
  IPv6 is enabled, link-local address is fe80::201:101
  Global unicast address(es):
    2002:201:101::1, subnet is 2002:201:101::/64
  ICMP error messages limited to one every 1000 milliseconds
  ICMP redirects are always sent
  ND DAD is enabled, number of DAD attempts: 1
  ND router advertisement is disabled
  ND reachable time is 30000 milliseconds
  ND advertised reachable time is 0 milliseconds
  ND retransmit interval is 1000 milliseconds
  ND advertised retransmit interval is 0 milliseconds
  ND router advertisements max interval: 600 secs
  ND router advertisements min interval: 198 secs
  ND router advertisements live for 1800 seconds
  ND router advertisements hop-limit is 0
  Hosts use stateless autoconfig for addresses.

```

Display the result on Switch2:

```

Switch# show interface tunnel1
Interface tunnel1
  Interface current state: UP
  Hardware is Tunnel
  Index 8193 , Metric 1 , Encapsulation TUNNEL
  VRF binding: not bound
  Tunnel protocol/transport IPv6/IP 6to4, Status Valid
  Tunnel source 6.1.1.1(eth-0-1), destination UNKNOWN
  Tunnel DSCP inherit, Tunnel TTL 64
  Tunnel transport MTU 1480 bytes

```

Configure ISATAP Tunnel

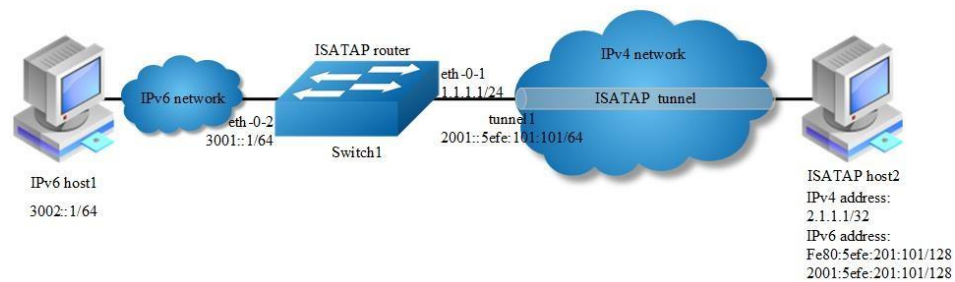

Figure 11-7 ISATAP tunnel

As shown in the above Figure, an IPv6 network is connected to an IPv4 network through an ISATAP router. It is required that the IPv6 host in the IPv4 network can access the IPv6 network through the ISATAP tunnel.

NOTE

- No destination address needs to be configured for a ISATAP tunnel
- The automatic tunnel interfaces using the same encapsulation protocol cannot share the same source IP address
- To encapsulate and forward IPv6 packets whose destination address does not belong to the network segment where the receiving tunnel interface resides, you need to configure a static route to reach the destination IPv6 address through this tunnel interface on the router. Because automatic tunnels do not support dynamic routing, you can configure a static route to that destination IPv6 address with this tunnel interface as the outbound interface or the peer tunnel interface address as the next hop

step 1 Enter the configure mode

```
Switch# configure terminal
```

step 2 Enable ipv6 globally

```
Switch(config)# ipv6 enable
```

step 3 Enter the interface configure mode and set the attributes of the interface

```
Switch(config)# interface eth-0-1
Switch(config-if)# no switchport
```



```
Switch(config-if)# ip address 1.1.1.1/24
Switch(config-if)# tunnel enable
Switch(config-if)# no shutdown
Switch(config-if)# exit

Switch(config)# interface eth-0-2
Switch(config-if)# no switchport
Switch(config-if)# ipv6 address 3001::1/64
Switch(config-if)# no shutdown
Switch(config-if)# exit

Switch(config)# interface tunnel1
Switch(config-if)# tunnel source eth-0-1
Switch(config-if)# tunnel mode ipv6ip isatap
Switch(config-if)# ipv6 address 2001::/64 eui-64
Switch(config-if)# no ipv6 nd ra suppress

Switch(config-if)# exit
```

step 4 Create static routes

```
Switch(config)# ip route 2.1.1.0/24 1.1.1.2
Switch(config)# ipv6 route 2001::/16 tunnel1
```

step 5 Configuring static arp

```
Switch(config)# arp 1.1.1.2 0.0.2222
```

step 6 Exit the configure mode

```
Switch(config)# end
```

step 7 Validation

```
Switch# show interface tunnel1
Interface tunnel1
  Interface current state: UP
  Hardware is Tunnel
  Index 8193 , Metric 1 , Encapsulation TUNNEL
  VRF binding: not bound
  Tunnel protocol/transport IPv6/IP ISATAP, Status Valid
  Tunnel source 1.1.1.1(eth-0-1), destination UNKNOWN
  Tunnel DSCP inherit, Tunnel TTL 64
  Tunnel transport MTU 1480 bytes

Switch# show ipv6 interface tunnel1
Interface tunnel1
  Interface current state: UP
  The maximum transmit unit is 1480 bytes
  IPv6 is enabled, link-local address is fe80::101:101
  Global unicast address(es):
    2001::101:101, subnet is 2001::/64 [EUI]
```

```

ICMP error messages limited to one every 1000 milliseconds
ICMP redirects are always sent
ND DAD is enabled, number of DAD attempts: 1
ND router advertisement is enabled
ND reachable time is 30000 milliseconds
ND advertised reachable time is 0 milliseconds
ND retransmit interval is 1000 milliseconds
ND advertised retransmit interval is 0 milliseconds
ND router advertisements max interval: 600 secs
ND router advertisements min interval: 198 secs
ND next router advertisement due in 359 secs.
ND router advertisements live for 1800 seconds
ND router advertisements hop-limit is 0
Hosts use stateless autoconfig for addresses.

```

Configure ISATAP host

The specific configuration on the ISATAP host is related to its operating system. The following example shows the configuration of the host running the Windows XP.

Install IPv6.

```
C:\>ipv6 install
```

On a Windows XP-based host, the ISATAP interface is usually interface 2. Configure the IPv4 address of the ISATAP router on interface 2 to complete the configuration on the host. Before that, display information on the ISATAP interface:

```

Interface 2: Automatic Tunneling Pseudo-Interface
  Guid {48FCE3FC-EC30-E50E-F1A7-71172AEEE3AE}
  does not use Neighbor Discovery
  does not use Router Discovery
  routing preference 1
  EUI-64 embedded IPv4 address: 0.0.0.0
  router link-layer address: 0.0.0.0
    preferred link-local fe80::5efe:2.1.1.1, life infinite
  link MTU 1280 (true link MTU 65515)
  current hop limit 128
  reachable time 25000ms (base 30000ms)
  retransmission interval 1000ms
  DAD transmits 0
  default site prefix length 48

```

A link-local address (fe80::5efe:2.1.1.2) in the ISATAP format was automatically generated for the ISATAP interface. Configure the IPv4 address of the ISATAP router on the ISATAP interface.

```
C:\>ipv6 rlu 2 1.1.1.1
```

After carrying out the above command, look at the information on the ISATAP interface.

```
Interface 2: Automatic Tunneling Pseudo-Interface
  Guid {48FCE3FC-EC30-E50E-F1A7-71172AEEE3AE}
  does not use Neighbor Discovery
  does not use Router Discovery
  routing preference 1
  EUI-64 embedded IPv4 address: 2.1.1.1
  router link-layer address: 1.1.1.1
  preferred global 2001::5efe:2.1.1.1, life 29d23h59m46s/6d23h59m46s (public)
    preferred link-local fe80::5efe:2.1.1.1, life infinite
  link MTU 1280 (true link MTU 65515)
  current hop limit 128
  reachable time 25000ms (base 30000ms)
  retransmission interval 1000ms
  DAD transmits 0
  default site prefix length 48
```

11.1.3 Application cases

N/A

11.2 Configuring ND

11.2.1 Overview

Function Introduction

Nodes (hosts and routers) use Neighbor Discovery to determine the link-layer addresses for neighbors known to reside on attached links and to quickly purge cached values that become invalid.

Hosts also use Neighbor Discovery to find neighboring routers that are willing to forward packets on their behalf.

Finally, nodes use the protocol to actively keep track of which neighbors are reachable and which are not, and to detect changed link-layer addresses. When a router or the path to a router fails, a host actively searches for functioning alternates.

Principle Description

N/A

11.2.2 Configuration

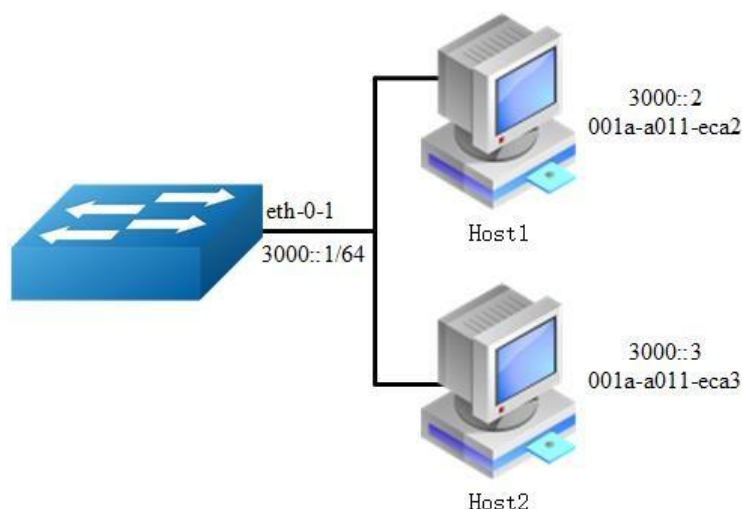

Figure 11-8 NDP

In this example, interface eth-0-1 assigned with ipv6 address 3000::1/64, on subnet 3000::/64, there are two hosts, and their IP addresses are 3000::2, 3000::3, MAC address are 001a-a011-eca2, 001a-a011-eca3. Neighbor entry of host 3000::2 is added manually, the entry of host 3000::3 is added dynamically. The reachable time of neighbor entries for interface eth-0-1 configure to 10 minutes, NS interval on interface eth-0-1 configure to 2 seconds.

step 1 Enter the configure mode

```
Switch# configure terminal
```

step 2 Enter the interface configure mode and set the attributes of the interface

```
Switch (config)# interface eth-0-1
Switch (config-if)# no switchport
Switch (config-if)# no shutdown
Switch (config-if)# ipv6 address 3000::1/64
Switch (config-if)# ipv6 nd reachable-time 600
Switch (config-if)# ipv6 nd ns-interval 2000
Switch (config-if)# exit
```

step 3 Add a static neighbor entry

```
Switch (config)# ipv6 neighbor 3000::2 001a.a011.eca2
```

step 4 Exit the configure mode

```
Switch(config)# end
```

step 5 Validation

```
Switch # show ipv6 neighbors
IPv6 address                               Age      Link-Layer Addr State Interface
3000::2                                     -        001a-a011-eca2 REACH eth-0-1
3000::3                                     6        001a-a011-eca3 REACH eth-0-1
fe80::6d8:e8ff:fe4c:e700                   6        001a-a011-eca3 STALE eth-0-1
```

11.2.3 Application cases

N/A

11.3 Configuring DHCPv6 Relay

11.3.1 Overview

Function Introduction

DHCPv6 relay is any host that forwards DHCPv6 packets between clients and servers. Relay is used to forward requests and replies between clients and servers when they are not on the same physical subnet. Relay forwarding is distinct from the normal forwarding of an IPv6 router, where IPv6 datagram are switched between networks somewhat transparently.

By contrast, relay receive DHCPv6 messages and then generate a new DHCPv6 message to send out on another interface. The relay sets the link address (used by server to identify the subnet that client is belong to), and, if configured, adds the remote-id option in the packet and forwards it to the DHCPv6 server..

Principle Description

N/A

11.3.2 Configuration

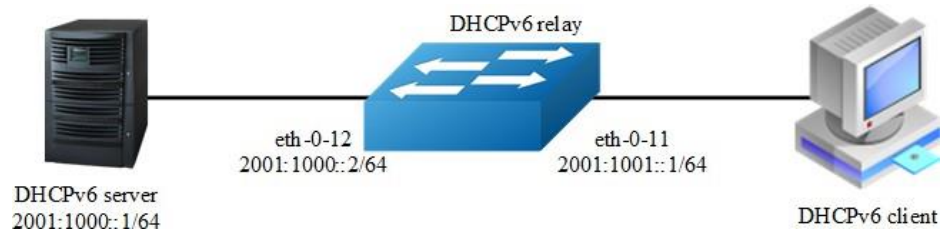

Figure 11-9 DHCP Relay

This figure is the networking topology for testing DHCPv6 relay functions. We need two Linux boxes and one Switch to construct the test bed.

- Computer A is used as DHCPv6 server.
- Computer B is used as DHCPv6 client.
- Switch is used as DHCPv6 relay.

step 1 Enter the configure mode

```
Switch# configure terminal
```

step 2 Enable DHCPv6 relay globally

```
Switch(config)# service dhcpv6 enable
Switch(config)# dhcpv6 relay
Switch(config)# dhcpv6 relay remote-id option
Switch(config)# dhcpv6 relay pd route
```

step 3 Configure the DHCPv6 server

```
Switch(config)# dhcpv6-server 1 2001:1000::1
```

step 4 Enter the interface configure mode and set the attributes of the interface

```
Switch(config)# interface eth-0-12
Switch(config-if)# no switchport
Switch(config-if)# ipv6 address 2001:1000::2/64
Switch(config-if)# no shutdown
Switch(config-if)# exit

Switch(config)# interface eth-0-11
Switch(config-if)# no switchport
Switch(config-if)# ipv6 address 2001:1001::1/64
Switch(config-if)# no shutdown
```

```
Switch(config-if)# dhcpv6-server 1
Switch(config-if)# exit
```

step 5 Exit the configure mode

```
Switch(config)# end
```

step 6 Validation

Check the interface configuration

```
Switch# show running-config interface eth-0-12
!
interface eth-0-12
  no switchport
  ipv6 address 2001:1000::1/64
!

Switch # show running-config interface eth-0-11
!
interface eth-0-11
  no switchport
  ipv6 address 2001:1001::1/64
  dhcpv6-server 1
!
```

Check the dhcpv6 service status

```
Switch# show services
Networking services configuration:
Service Name          Status
=====
dhcp                  disable
dhcpv6                enable
```

Check the dhcpv6 server group configuration

```
Switch# show dhcpv6-server
DHCPv6 server group information:
=====
group 1 ipv6 address list:
[1] 2001:1000::1
```

Check the dhcpv6 relay statistics.

```
Switch# show dhcpv6 relay statistics
DHCPv6 relay packet statistics:
=====
Client relayed packets : 8
Server relayed packets : 8

Client error packets   : 0
Server error packets   : 0
```

Check the prefix-delegation client information learning by DHCPv6 relay

```
Switch# show dhcpv6 relay pd client
DHCPv6 prefix-delegation client information:
=====
Interface   : eth-0-11
Client DUID  : 000100011804ff38c2428f04970
Client IPv6 address : fe80::beac:d8ff:fedf:c600
  IA ID      : d8dfc60
    IA Prefix : 2002:2:9:eebe::/64
      preferred/max lifetime : 280/300
      expired time : 2001-1-1 09:10:58
=====
```

11.3.3 Application cases

N/A

12 IPv6 Security Configuration Guide

12.1 DHCPv6 Snooping Configuration

12.1.1 Overview

Function Introduction

DHCPv6 snooping is a security feature that acts like a firewall between untrusted hosts and trusted DHCPv6 servers. The DHCPv6 snooping feature performs the following activities:

- Validate DHCPv6 messages received from untrusted sources and filters out invalid messages.
- Build and maintain the DHCPv6 snooping binding database, which contains information about untrusted hosts with leased IPv6 addresses.
- The DHCPv6 snooping feature is implemented in software basis. All DHCPv6 messages are intercepted in the chip and directed to the CPU for processing.

Principle Description

N/A

12.1.2 Configuration

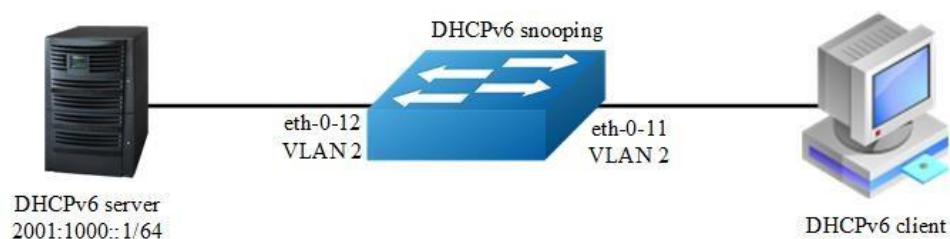

Figure 12-1 DHCPv6 Snooping

This figure is the networking topology for testing DHCPv6 snooping functions. We need two PCs and one switch to construct the test bed.

- PC A is used as a DHCPv6 server.
- PC B is used as a DHCPv6 client.
- Switch A is used as a DHCPv6 Snooping device.

step 1 Enter the configure mode

```
Switch# configure terminal
```

step 2 Enter the vlan configure mode and create the vlan

```
Switch(config)# vlan database  
Switch(config-vlan)# vlan 2  
Switch(config-vlan)# exit
```

step 3 Enter the interface configure mode and set the attributes of the interface

```
Switch(config)# interface eth-0-11  
Switch(config-if)# switchport  
Switch(config-if)# switchport access vlan 2  
Switch(config-if)# no shutdown  
Switch(config-if)# exit  
  
Switch(config)# interface eth-0-12  
Switch(config-if)# switchport  
Switch(config-if)# switchport access vlan 2  
Switch(config-if)# dhcpv6 snooping trust  
Switch(config-if)# no shutdown  
Switch(config-if)# exit
```

step 4 Enable DHCPv6 snooping globally and set the attributes

```
Switch(config)# service dhcpv6 enable  
Switch(config)# dhcpv6 snooping  
Switch(config)# dhcpv6 snooping vlan 2
```

step 5 Exit the configure mode

```
Switch(config)# end
```

step 6 Validation

Check the interface configuration.

```
Switch# show running-config interface eth-0-12
!
interface eth-0-12
switchport access vlan 2
dhcpv6 snooping trust
!
Switch# show running-config interface eth-0-11
!
interface eth-0-11
switchport access vlan 2
!
```

Check the dhcpv6 service status.

```
Switch# show services
Networking services configuration:
Service Name          Status
=====
dhcp                  disable
dhcpv6                enable
```

Show dhcpv6 snooping statistics.

```
Switch# show dhcpv6 snooping config
dhcpv6 snooping service: enabled
dhcpv6 snooping switch: enabled
dhcpv6 snooping vlan 2
```

Enable DHCPv6 snooping global feature

```
Switch# show dhcpv6 snooping statistics
DHCPv6 snooping statistics:
=====
DHCPv6 packets                21

Packets forwarded              21
Packets invalid                0
Packets dropped                0
```

Step 5 Show dhcpv6 snooping binding information

```
Switch# show dhcpv6 snooping binding all
DHCPv6 snooping binding table:
VLAN MAC Address      Lease(s)   Interface  IPv6 Address
=====
2      0016.76a1.7ed9 978       eth-0-11   2001:1000::2
```

12.1.3 Application cases

N/A

13 IPv6 Routing Configuration

13.1 Configuring IPv6 Unicast-Routing

13.1.1 Overview

Function Introduction

Static routing is a concept describing one way of configuring path selection of routers in computer networks. It is the type of routing characterized by the absence of communication between routers regarding the current topology of the network. This is achieved by manually adding routes to the routing table. The opposite of static routing is dynamic routing, sometimes also referred to as adaptive routing.

In these systems, routes through a data network are described by fixed paths (statically). These routes are usually entered into the router by the system administrator. An entire network can be configured using static routes, but this type of configuration is not fault tolerant. When there is a change in the network or a failure occurs between two statically defined nodes, traffic will not be rerouted. This means that anything that wishes to take an affected path will either have to wait for the failure to be repaired or the static route to be updated by the administrator before restarting its journey. Most requests will time out (ultimately failing) before these repairs can be made. There are, however, times when static routes can improve the performance of a network. Some of these include stub networks and default routes.

Principle Description

N/A

13.1.2 Configuration



Figure 13-1 ipv6 unicast routing

The following example shows how to deploy static routes in a simple environment.

The following configuration should be operated on all switches if the switch ID is not specified.

step 1 Enter the configure mode

```
Switch# configure terminal
```

step 2 Enable ipv6 globally

```
Switch(config)# ipv6 enable
```

step 3 Enter the interface configure mode and set the attributes of the interface

Interface configuration for Switch1:

```
Switch(config)# interface eth-0-9
Switch(config-if)# no switchport
Switch(config-if)# no shutdown
Switch(config-if)# ipv6 address auto link-local
Switch(config-if)# ipv6 address 2001:1::1/64
Switch(config-if)# exit
```

Interface configuration for Switch2:

```
Switch(config)# interface eth-0-9
Switch(config-if)# no switchport
Switch(config-if)# no shutdown
Switch(config-if)# ipv6 address auto link-local
Switch(config-if)# ipv6 address 2001:1::2/64
Switch(config-if)# exit

Switch(config)# interface eth-0-17
Switch(config-if)# no switchport
Switch(config-if)# no shutdown
Switch(config-if)# ipv6 address auto link-local
Switch(config-if)# ipv6 address 2001:2::2/64
Switch(config-if)# exit
```

Interface configuration for Switch3:

```
Switch(config)# interface eth-0-17
Switch(config-if)# no switchport
Switch(config-if)# no shutdown
Switch(config-if)# ipv6 address auto link-local
Switch(config-if)# ipv6 address 2001:2::3/64
Switch(config-if)# exit
```

step 4 Create static routes

Configuring Switch1:

```
Switch(config)# ipv6 route 2001:2::/64 2001:1::2
```

Configuring Switch3:

```
Switch(config)# ipv6 route 2001:1::/64 2001:2::2
```

step 5 Exit the configure mode

```
Switch(config)# end
```

step 6 Validation

Display the result on Switch1:

```
Switch# show ipv6 route
IPv6 Routing Table
Codes: C - connected, S - static, R - RIP, O - OSPF, I - IS-IS, B - BGP
      [*] - [AD/Metric]
Timers: Uptime
C      2001:1::/64
      via ::, eth-0-9, 02:08:50
C      2001:1::1/128
      via ::1, eth-0-9, 02:08:50
S      2001:2::/64 [1/0]
      via 2001:1::2, eth-0-9, 02:05:36
C      fe80::/10
      via ::, Null0, 02:09:11
```

Display the result on Switch2:

```
Switch# show ipv6 route
IPv6 Routing Table
Codes: C - connected, S - static, R - RIP, O - OSPF, I - IS-IS, B - BGP
      [*] - [AD/Metric]
Timers: Uptime
C      2001:1::/64
      via ::, eth-0-9, 00:03:37
C      2001:1::2/128
      via ::1, eth-0-9, 00:03:37
C      2001:2::/64
      via ::, eth-0-17, 00:03:21
C      2001:2::2/128
```

```
via ::1, eth-0-17, 00:03:21
C    fe80::/10
    via ::, Null0, 00:03:44
```

Display the result on Switch3:

```
Switch# show ipv6 route
IPv6 Routing Table
Codes: C - connected, S - static, R - RIP, O - OSPF, I - IS-IS, B - BGP
      [*] - [AD/Metric]
Timers: Uptime
S    2001:1::/64 [1/0]
    via 2001:2::2, eth-0-17, 00:02:14
C    2001:2::/64
    via ::, eth-0-17, 00:03:28
C    2001:2::3/128
    via ::1, eth-0-17, 00:03:28
C    fe80::/10
    via ::, Null0, 00:03:53
```

Use the "ping" command on switch1 to contact the switch3:

```
Switch1# ping ipv6 2001:2::3
PING 2001:2::3(2001:2::3) 56 data bytes
64 bytes from 2001:2::3: icmp_seq=0 ttl=63 time=127 ms
64 bytes from 2001:2::3: icmp_seq=1 ttl=63 time=132 ms
64 bytes from 2001:2::3: icmp_seq=2 ttl=63 time=124 ms
64 bytes from 2001:2::3: icmp_seq=3 ttl=63 time=137 ms
64 bytes from 2001:2::3: icmp_seq=4 ttl=63 time=141 ms
--- 2001:2::3 ping statistics ---
5 packets transmitted, 5 received, 0% packet loss, time 4010ms
rtt min/avg/max/mdev = 124.950/132.719/141.251/5.923 ms, pipe 2
```

13.1.3 Application cases

N/A

13.2 Configuring OSPFv3

13.2.1 Overview

Function Introduction

OSPF is an Interior Gateway Protocol (IGP) designed expressly for IP networks, supporting IP subnet ting and tagging of externally derived routing information.

The implementation conforms to the OSPF Version 3, which is described in RFC 5340, expands on OSPF version 2 to support IPv6 routing prefixes. Much of the OSPF for

IPv6 feature is the same as in OSPF version 2. Changes between OSPF for IPv4, OSPF Version 2, and OSPF for IPv6 as described herein include the following:

- Addressing semantics have been removed from OSPFv3 packets and the basic Link State Advertisements (LSAs).
- OSPFv3 now runs on a per-link basis rather than on a per-IP-subnet basis.
- Authentication has been removed from the OSPFv3 protocol.

Principle Description

The OSPFv3 module is based on the following RFC: RFC 5340 - OSPF for IPv6

13.2.2 Configuration

Basic OSPFv3 Parameters Configuration

step 1 Enter the configure mode

```
Switch# configure terminal
```

step 2 Create OSPFv3 instance

```
Switch(config)# router ipv6 ospf 100
Switch(config-router)# router-id 1.1.1.1
Switch(config-router)# exit
```



NOTE Use the command “no router ipv6 ospf process-id” in global configure mode to delete the OSPFv3 instance.

step 3 Exit the configure mode

```
Switch(config)# end
```

step 4 Validation

```
Switch# show ipv6 protocols
Routing Protocol is "OSPFv3 (100)" with ID 1.1.1.1
  Redistributing:
  Routing for Networks:
  Distance: (default is 110)
```

Enabling OSPFv3 on an Interface

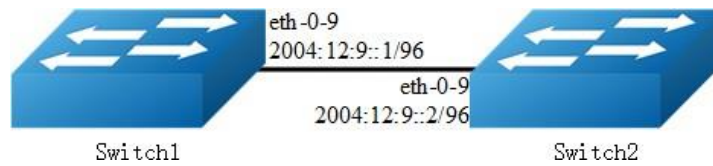

Figure 13-2 OSPFv3

This example shows the minimum configuration required for enabling OSPFv3 on an interface. Switch1 and 2 are two routers in Area 0 connecting to prefix 2004:12:9::/96.

The following configuration should be operated on all switches if the switch ID is not specified.

step 1 Enter the configure mode

```
Switch# configure terminal
```

step 2 Enable ipv6 globally

```
Switch(config)# ipv6 enable
```

step 3 Create OSPFv3 instance

Configuring Switch1:

```
Switch(config)# router ipv6 ospf 100
Switch(config-router)# router-id 1.1.1.1
Switch(config-router)# exit
```

Configuring Switch2:

```
Switch(config)# router ipv6 ospf 200
Switch(config-router)# router-id 2.2.2.2
Switch(config-router)# exit
```

step 4 Enter the interface configure mode and set the attributes of the interface

Interface configuration for Switch1:

```
Switch(config)# interface eth-0-9
Switch(config-if)# no switchport
Switch(config-if)# no shutdown
Switch(config-if)# ipv6 address 2004:12:9::1/96
Switch(config-if)# ipv6 router ospf 100 area 0 instance 0
Switch(config-if)# exit
```

Interface configuration for Switch2:

```
Switch(config)# interface eth-0-9
Switch(config-if)# no switchport
Switch(config-if)# no shutdown
Switch(config-if)# ipv6 address 2004:12:9::2/96
Switch(config-if)# ipv6 router ospf 200 area 0 instance 0
Switch(config-if)# exit
```

step 3 Exit the configure mode

```
Switch(config)# end
```

step 4 Validation**Display the result on Switch1:**

```
Switch# show ipv6 ospf database
          OSPFv3 Router with ID (1.1.1.1) (Process 100)
          Link-LSA (Interface eth-0-9)
Link State ID  ADV Router      Age  Seq#          CkSum  Prefix
0.0.0.9        1.1.1.1                    614 0x80000001 0x6a40    1
0.0.0.9        2.2.2.2                    68 0x80000001 0x4316    1
          Router-LSA (Area 0.0.0.0)
Link State ID  ADV Router      Age  Seq#          CkSum  Link
0.0.0.0        1.1.1.1                    54 0x80000003 0xb74b    1
0.0.0.0        2.2.2.2                    55 0x80000003 0x9965    1
          Network-LSA (Area 0.0.0.0)
Link State ID  ADV Router      Age  Seq#          CkSum
0.0.0.9        1.1.1.1                    54 0x80000001 0x3ed1
          Intra-Area-Prefix-LSA (Area 0.0.0.0)
Link State ID  ADV Router      Age  Seq#          CkSum  Prefix  Reference
0.0.0.2        1.1.1.1                    53 0x80000001 0x450a    1  Network-LSA

Switch# show ipv6 ospf neighbor
OSPFv3 Process (100)
Neighbor ID    Pri  State           Dead Time   Interface  Instance ID
2.2.2.2        1   Full/Backup     00:00:33   eth-0-9    0

Switch# show ipv6 ospf route
OSPFv3 Process (100)
Codes: C - connected, D - Discard, O - OSPF, IA - OSPF inter area
       E1 - OSPF external type 1, E2 - OSPF external type 2
Destination                               Metric
Next-hop
C 2004:12:9::/96                            1
   directly connected, eth-0-9, Area 0.0.0.0
```

Display the result on Switch2:

```
Switch# show ipv6 ospf database
          OSPFv3 Router with ID (2.2.2.2) (Process 200)
          Link-LSA (Interface eth-0-9)
```

```

Link State ID  ADV Router      Age  Seq#      CkSum  Prefix
0.0.0.9       1.1.1.1      774  0x80000001 0x6a40  1
0.0.0.9       2.2.2.2      228  0x80000001 0x4316  1
Router-LSA (Area 0.0.0.0)
Link State ID  ADV Router      Age  Seq#      CkSum  Link
0.0.0.0       1.1.1.1      217  0x80000003 0xb74b  1
0.0.0.0       2.2.2.2      214  0x80000003 0x9965  1
Network-LSA (Area 0.0.0.0)
Link State ID  ADV Router      Age  Seq#      CkSum
0.0.0.9       1.1.1.1      215  0x80000001 0x3ed1
Intra-Area-Prefix-LSA (Area 0.0.0.0)
Link State ID  ADV Router      Age  Seq#      CkSum  Prefix  Reference
0.0.0.2       1.1.1.1      214  0x80000001 0x450a  1  Network-LSA

Switch# show ipv6 ospf neighbor
OSPFv3 Process (200)
Neighbor ID    Pri  State          Dead Time  Interface  Instance ID
1.1.1.1       1   Full/DR        00:00:35  eth-0-9    0

Switch# show ipv6 ospf route
OSPFv3 Process (200)
Codes: C - connected, D - Discard, O - OSPF, IA - OSPF inter area
       E1 - OSPF external type 1, E2 - OSPF external type 2
Destination                                Metric
Next-hop
C 2004:12:9::/96                            1
   directly connected, eth-0-9, Area 0.0.0.0

```

Configuring Priority

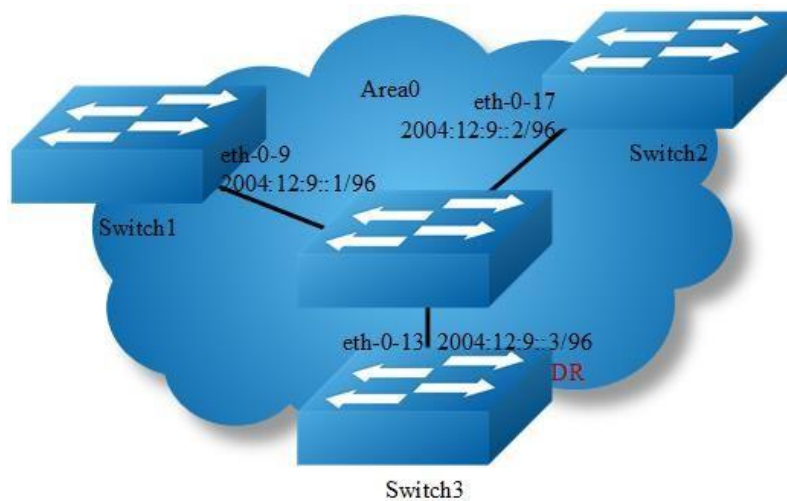

Figure 13-3 OSPFv3 priority

This example shows the configuration for setting the priority for an interface. You can set a high priority for a router to make it the Designated Router (DR). Router

Switch3 is configured to have a priority of 10, which is higher than the default priority (default priority is 1) of Switch1 and 2; making it the DR.

The following configuration should be operated on all switches if the switch ID is not specified.

step 1 Enter the configure mode

```
Switch# configure terminal
```

step 2 Enable ipv6 globally

```
Switch(config)# ipv6 enable
```

step 3 Create OSPFv3 instance

Configuring Switch1:

```
Switch(config)# router ipv6 ospf 100
Switch(config-router)# router-id 1.1.1.1
Switch(config-router)# exit
```

Configuring Switch2:

```
Switch(config)# router ipv6 ospf 200
Switch(config-router)# router-id 2.2.2.2
Switch(config-router)# exit
```

Configuring Switch3:

```
Switch(config)# router ipv6 ospf 300
Switch(config-router)# router-id 3.3.3.3
Switch(config-router)# exit
```

step 4 Enter the interface configure mode and set the attributes of the interface

Interface configuration for Switch1:

```
Switch(config)# interface eth-0-9
Switch(config-if)# no switchport
Switch(config-if)# no shutdown
Switch(config-if)# ipv6 address 2004:12:9::1/96
Switch(config-if)# ipv6 router ospf 100 area 0 instance 0
Switch(config-if)# exit
```

Interface configuration for Switch2:

```
Switch(config)# interface eth-0-17
Switch(config-if)# no switchport
Switch(config-if)# no shutdown
```

```
Switch(config-if)# ipv6 address 2004:12:9::2/96
Switch(config-if)# ipv6 router ospf 200 area 0 instance 0
Switch(config-if)# exit
```

Interface configuration for Switch3:

```
Switch(config)# interface eth-0-13
Switch(config-if)# no switchport
Switch(config-if)# no shutdown
Switch(config-if)# ipv6 address 2004:12:9::3/96
Switch(config-if)# ipv6 router ospf 300 area 0 instance 0
Switch(config-if)# ipv6 ospf priority 10
Switch(config-if)# exit
```

step 5 Exit the configure mode

```
Switch(config)# end
```

step 6 Validation

Display the result on Switch1:

```
Switch# show ipv6 ospf neighbor
OSPFv3 Process (100)
Neighbor ID      Pri   State           Dead Time   Interface   Instance ID
2.2.2.2          1    Full/Backup     00:00:31   eth-0-9    0
3.3.3.3          10   Full/DR         00:00:36   eth-0-9    0
Switch#
Switch# show ipv6
interface        isis          mif           mld           mroute        mroute-rpf
multicast        neighbors     ospf          pim           prefix-list    protocols
rip              route
Switch# show ipv6 ospf interface
eth-0-9 is up, line protocol is up
  Interface ID 9
  IPv6 Prefixes
    fe80::20e6:7eff:fee2:d400/10 (Link-Local Address)
    2004:12:9::1/96
  OSPFv3 Process (100), Area 0.0.0.0, Instance ID 0
  Router ID 1.1.1.1, Network Type BROADCAST, Cost: 1
  Transmit Delay is 1 sec, State DROther, Priority 1
  Designated Router (ID) 3.3.3.3
    Interface Address fe80::ba5d:79ff:fe55:ed00
  Backup Designated Router (ID) 2.2.2.2
    Interface Address fe80::fcc8:7bff:fe3e:ec00
  Timer interval configured, Hello 10, Dead 40, Wait 40, Retransmit 5
  Hello due in 00:00:03
  Neighbor Count is 2, Adjacent neighbor count is 2
```

Display the result on Switch2:

```
Switch# show ipv6 ospf neighbor
OSPFv3 Process (200)
Neighbor ID      Pri   State           Dead Time   Interface   Instance ID
```

```

1.1.1.1          1    Full/DROther      00:00:31    eth-0-17    0
3.3.3.3          10   Full/DR            00:00:37    eth-0-17    0

Switch# show ipv6 ospf interface
eth-0-17 is up, line protocol is up
  Interface ID 17
  IPv6 Prefixes
    fe80::fcc8:7bff:fe3e:ec00/10 (Link-Local Address)
    2004:12:9::2/96
  OSPFv3 Process (200), Area 0.0.0.0, Instance ID 0
  Router ID 2.2.2.2, Network Type BROADCAST, Cost: 1
  Transmit Delay is 1 sec, State Backup, Priority 1
  Designated Router (ID) 3.3.3.3
    Interface Address fe80::ba5d:79ff:fe55:ed00
  Backup Designated Router (ID) 2.2.2.2
    Interface Address fe80::fcc8:7bff:fe3e:ec00
  Timer interval configured, Hello 10, Dead 40, Wait 40, Retransmit 5
  Hello due in 00:00:07
  Neighbor Count is 2, Adjacent neighbor count is 2

```

Display the result on Switch3:

```

Switch# show ipv6 ospf neighbor
OSPFv3 Process (300)
Neighbor ID      Pri   State                Dead Time   Interface   Instance ID
1.1.1.1          1    Full/DROther         00:00:40   eth-0-13    0
2.2.2.2          1    Full/Backup          00:00:29   eth-0-13    0

Switch# show ipv6 ospf interface
eth-0-13 is up, line protocol is up
  Interface ID 13
  IPv6 Prefixes
    fe80::ba5d:79ff:fe55:ed00/10 (Link-Local Address)
    2004:12:9::3/96
  OSPFv3 Process (300), Area 0.0.0.0, Instance ID 0
  Router ID 3.3.3.3, Network Type BROADCAST, Cost: 1
  Transmit Delay is 1 sec, State DR, Priority 10
  Designated Router (ID) 3.3.3.3
    Interface Address fe80::ba5d:79ff:fe55:ed00
  Backup Designated Router (ID) 2.2.2.2
    Interface Address fe80::fcc8:7bff:fe3e:ec00
  Timer interval configured, Hello 10, Dead 40, Wait 40, Retransmit 5
  Hello due in 00:00:06
  Neighbor Count is 2, Adjacent neighbor count is 2

```

Configuring OSPFv3 Area Parameters

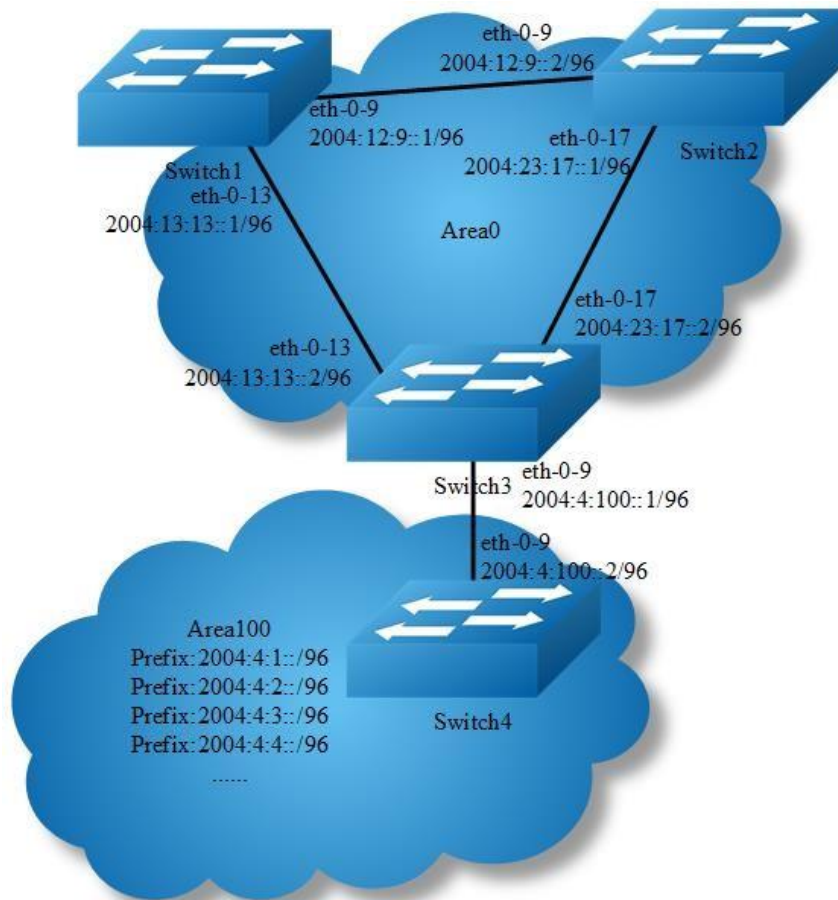

Figure 13-4 OSPFv3 area

You can optionally configure several OSPFv3 area parameters. These parameters include authentication for password-based protection against unauthorized access to an area and stub areas. Stub areas are areas into which information on external routes is not sent. Instead, the area border router (ABR) generates a default external route into the stub area for destinations outside the autonomous system (AS).

Route summarization is the consolidation of advertised addresses into a single summary route to be advertised by other areas. If network numbers are contiguous, you can use the area range router configuration command to configure the ABR to advertise a summary route that covers all networks in the range.

The following configuration should be operated on all switches if the switch ID is not specified.

step 1 Enter the configure mode

```
Switch# configure terminal
```

step 2 Enable ipv6 globally

```
Switch(config)# ipv6 enable
```

step 3 Create OSPFv3 instance

Configuring Switch1:

```
Switch(config)# router ipv6 ospf 100
Switch(config-router)# router-id 1.1.1.1
Switch(config-router)# exit
```

Configuring Switch2:

```
Switch(config)# router ipv6 ospf 200
Switch(config-router)# router-id 2.2.2.2
Switch(config-router)# exit
```

Configuring Switch3:

```
Switch(config)# router ipv6 ospf 300
Switch(config-router)# router-id 3.3.3.3
Switch(config-router)# exit

Switch(config)# router ipv6 ospf 300
Switch(config-router)# area 100 range 2004:4::/32
Switch(config-router)# area 100 stub no-summary
Switch(config-router)# exit
```

Configuring Switch4:

```
Switch(config)# router ipv6 ospf 400
Switch(config-router)# router-id 4.4.4.4
Switch(config-router)# area 100 stub no-summary
Switch(config-router)# exit
```

step 4 Enter the interface configure mode and set the attributes of the interface

Interface configuration for Switch1:

```
Switch(config)# interface eth-0-9
Switch(config-if)# no switchport
Switch(config-if)# no shutdown
Switch(config-if)# ipv6 address 2004:12:9::1/96
Switch(config-if)# ipv6 router ospf 100 area 0 instance 0
Switch(config-if)# exit

Switch(config)#interface eth-0-13
```



```
Switch(config-if)#no switchport
Switch(config-if)#no shutdown
Switch(config-if)# ipv6 address 2004:13:13::2/96
Switch(config-if)# ipv6 router ospf 100 area 0 instance 0
Switch(config-if)# exit
```

Interface configuration for Switch2:

```
Switch(config)# interface eth-0-9
Switch(config-if)# no switchport
Switch(config-if)# no shutdown
Switch(config-if)# ipv6 address 2004:12:9::2/96
Switch(config-if)# ipv6 router ospf 200 area 0 instance 0
Switch(config-if)# exit
```

```
Switch(config)#interface eth-0-17
Switch(config-if)#no switchport
Switch(config-if)#no shutdown
Switch(config-if)# ipv6 address 2004:23:17::1/96
Switch(config-if)# ipv6 router ospf 200 area 0 instance 0
Switch(config-if)# exit
```

Interface configuration for Switch3:

```
Switch(config)# interface eth-0-9
Switch(config-if)# no switchport
Switch(config-if)# no shutdown
Switch(config-if)# ipv6 address 2004:4:100::1/96
Switch(config-if)# ipv6 router ospf 300 area 100 instance 0
Switch(config-if)# exit
```

```
Switch(config)# interface eth-0-13
Switch(config-if)# no switchport
Switch(config-if)# no shutdown
Switch(config-if)# ipv6 address 2004:13:13::2/96
Switch(config-if)# ipv6 router ospf 300 area 0 instance 0
Switch(config-if)# exit
```

```
Switch(config)# interface eth-0-17
Switch(config-if)# no switchport
Switch(config-if)# no shutdown
Switch(config-if)# ipv6 address 2004:23:17::2/96
Switch(config-if)# ipv6 router ospf 300 area 0 instance 0
Switch(config-if)# exit
```

Interface configuration for Switch4:

```
Switch(config)# interface eth-0-1
Switch(config-if)# no switchport
Switch(config-if)# no shutdown
Switch(config-if)# ipv6 address 2004:4:1::1/96
Switch(config-if)# ipv6 router ospf 400 area 100 instance 0
Switch(config-if)# exit
```

```
Switch(config)# interface eth-0-2
Switch(config-if)# no switchport
```

```

Switch(config-if)# no shutdown
Switch(config-if)# ipv6 address 2004:4:2::1/96
Switch(config-if)# ipv6 router ospf 400 area 100 instance 0
Switch(config-if)# exit

Switch(config)# interface eth-0-3
Switch(config-if)# no switchport
Switch(config-if)# no shutdown
Switch(config-if)# ipv6 address 2004:4:3::1/96
Switch(config-if)# ipv6 router ospf 400 area 100 instance 0
Switch(config-if)# exit

Switch(config)# interface eth-0-4
Switch(config-if)# no switchport
Switch(config-if)# no shutdown
Switch(config-if)# ipv6 address 2004:4:4::1/96
Switch(config-if)# ipv6 router ospf 400 area 100 instance 0
Switch(config-if)# exit

Switch(config)# interface eth-0-9
Switch(config-if)# no switchport
Switch(config-if)# no shutdown
Switch(config-if)# ipv6 address 2004:4:100::2/96
Switch(config-if)# ipv6 router ospf 400 area 100 instance 0
Switch(config-if)# exit

```

step 5 Exit the configure mode

```
Switch(config)# end
```

step 6 Validation

Display the result on Switch1:

```

Switch# show ipv6 route
IPv6 Routing Table
Codes: C - connected, S - static, R - RIP, I - IS-IS, B - BGP
       O - OSPF, IA - OSPF inter area
       N1 - OSPF NSSA external type 1, N2 - OSPF NSSA external type 2
       E1 - OSPF external type 1, E2 - OSPF external type 2
       Dr - DHCPV6 Relay
       [*] - [AD/Metric]
Timers: Uptime
O IA   2004:4::/32 [110/3]
       via fe80::c629:f2ff:fe02:3600, eth-0-13, 00:01:00
C      2004:12:9::/96
       via ::, eth-0-9, 00:15:56
C      2004:12:9::1/128
       via ::1, eth-0-9, 00:15:56
C      2004:13:13::/96
       via ::, eth-0-13, 00:15:55
C      2004:13:13::2/128
       via ::1, eth-0-13, 00:15:55

```

```
O    2004:23:17::/96 [110/2]
    via fe80::bc22:aeff:fe64:aa00, eth-0-9, 00:08:10
    via fe80::c629:f2ff:fe02:3600, eth-0-13, 00:08:10
C    fe80::/10
    via ::, Null10, 00:15:57
```

Display the result on Switch2:

```
Switch# show ipv6 route
IPv6 Routing Table
Codes: C - connected, S - static, R - RIP, I - IS-IS, B - BGP
       O - OSPF, IA - OSPF inter area
       N1 - OSPF NSSA external type 1, N2 - OSPF NSSA external type 2
       E1 - OSPF external type 1, E2 - OSPF external type 2
       Dr - DHCPV6 Relay
       [*] - [AD/Metric]
Timers: Uptime
O IA  2004:4::/32 [110/3]
    via fe80::c629:f2ff:fe02:3600, eth-0-17, 00:00:57
C    2004:12:9::/96
    via ::, eth-0-9, 00:12:24
C    2004:12:9::2/128
    via ::1, eth-0-9, 00:12:24
O    2004:13:13::/96 [110/2]
    via fe80::b242:55ff:fe05:ff00, eth-0-9, 00:07:52
    via fe80::c629:f2ff:fe02:3600, eth-0-17, 00:07:52
C    2004:23:17::/96
    via ::, eth-0-17, 00:12:24
C    2004:23:17::1/128
    via ::1, eth-0-17, 00:12:24
C    fe80::/10
    via ::, Null10, 00:12:26
```

Display the result on Switch3:

```
Switch# show ipv6 route
IPv6 Routing Table
Codes: C - connected, S - static, R - RIP, I - IS-IS, B - BGP
       O - OSPF, IA - OSPF inter area
       N1 - OSPF NSSA external type 1, N2 - OSPF NSSA external type 2
       E1 - OSPF external type 1, E2 - OSPF external type 2
       Dr - DHCPV6 Relay
       [*] - [AD/Metric]
Timers: Uptime
O    2004:4::/32 [110/0]
    via ::, Null10, 00:08:31
O    2004:4:1::/96 [110/2]
    via fe80::ee66:91ff:fe45:db00, eth-0-9, 00:01:08
O    2004:4:2::/96 [110/2]
    via fe80::ee66:91ff:fe45:db00, eth-0-9, 00:01:08
O    2004:4:3::/96 [110/2]
    via fe80::ee66:91ff:fe45:db00, eth-0-9, 00:01:08
O    2004:4:4::/96 [110/2]
    via fe80::ee66:91ff:fe45:db00, eth-0-9, 00:01:08
C    2004:4:100::/96
    via ::, eth-0-9, 00:08:32
```

```

C    2004:4:100::1/128
    via ::1, eth-0-9, 00:08:32
O    2004:12:9::/96 [110/2]
    via fe80::b242:55ff:fe05:ff00, eth-0-13, 00:08:03
    via fe80::bc22:aeff:fe64:aa00, eth-0-17, 00:08:03
O    2004:13:13::/96 [110/1]
    via fe80::b242:55ff:fe05:ff00, eth-0-13, 00:08:18
C    2004:23:17::/96
    via ::, eth-0-17, 00:08:32
C    2004:23:17::2/128
    via ::1, eth-0-17, 00:08:32
C    fe80::/10
    via ::, Null0, 00:08:34

```

Display the result on Switch4:

```

Switch# show ipv6 route
IPv6 Routing Table
Codes: C - connected, S - static, R - RIP, I - IS-IS, B - BGP
       O - OSPF, IA - OSPF inter area
       N1 - OSPF NSSA external type 1, N2 - OSPF NSSA external type 2
       E1 - OSPF external type 1, E2 - OSPF external type 2
       Dr - DHCPV6 Relay
       [*] - [AD/Metric]
Timers: Uptime
O IA  ::/0 [110/2]
    via fe80::c629:f2ff:fe02:3600, eth-0-9, 00:00:53
C    2004:4:1::/96
    via ::, eth-0-1, 00:03:09
C    2004:4:1::1/128
    via ::1, eth-0-1, 00:03:09
C    2004:4:2::/96
    via ::, eth-0-2, 00:03:08
C    2004:4:2::1/128
    via ::1, eth-0-2, 00:03:08
C    2004:4:3::/96
    via ::, eth-0-3, 00:03:08
C    2004:4:3::1/128
    via ::1, eth-0-3, 00:03:08
C    2004:4:4::/96
    via ::, eth-0-4, 00:03:09
C    2004:4:4::1/128
    via ::1, eth-0-4, 00:03:09
C    2004:4:100::/96
    via ::, eth-0-9, 00:03:09
C    2004:4:100::2/128
    via ::1, eth-0-9, 00:03:09
C    fe80::/10
    via ::, Null0, 00:03:10

```

Redistributing Routes into OSPFv3

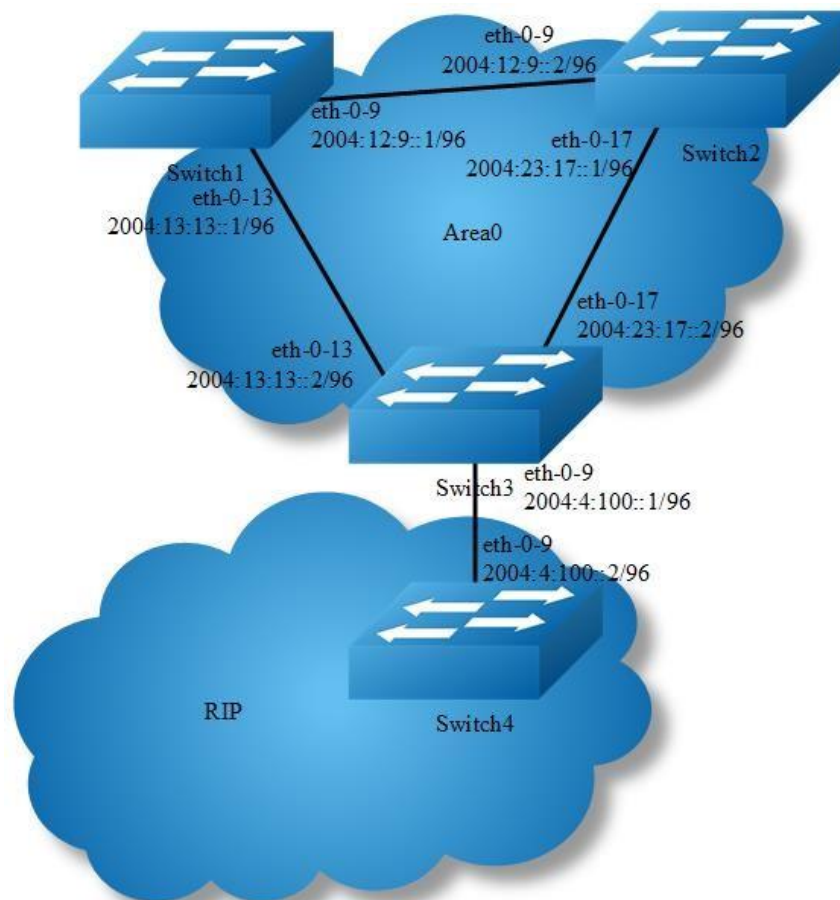

Figure 13-5 OSPFv3 Redistribute

In this example the configuration causes RIPng routes to be imported into the OSPFv3 routing table and advertised as Type 5 External LSAs into Area 0.

The following configuration should be operated on all switches if the switch ID is not specified.

step 1 Enter the configure mode

```
Switch# configure terminal
```

step 2 Enable ipv6 globally

```
Switch(config)# ipv6 enable
```

step 3 Create OSPFv3 instance

Configuring Switch1:

```
Switch(config)# router ipv6 ospf 100
Switch(config-router)# router-id 1.1.1.1
Switch(config-router)# exit
```

Configuring Switch2:

```
Switch(config)# router ipv6 ospf 200
Switch(config-router)# router-id 2.2.2.2
Switch(config-router)# exit
```

Configuring Switch3:

```
Switch(config)# router ipv6 ospf 300
Switch(config-router)# router-id 3.3.3.3
Switch(config-router)# redistribute ripng
Switch(config-router)# exit
```

step 4 Create RIPng instance

Configuring Switch3:

```
Switch(config)# router ipv6 rip
Switch(config-router)# exit
```

Configuring Switch4:

```
Switch(config)# router ipv6 rip
Switch(config-router)# exit
```

step 5 Enter the interface configure mode and set the attributes of the interface

Interface configuration for Switch1:

```
Switch(config)# interface eth-0-9
Switch(config-if)# no switchport
Switch(config-if)# no shutdown
Switch(config-if)# ipv6 address 2004:12:9::1/96
Switch(config-if)# ipv6 router ospf 100 area 0 instance 0
Switch(config-if)# exit

Switch(config)#interface eth-0-13
Switch(config-if)# no switchport
Switch(config-if)# no shutdown
Switch(config-if)# ipv6 address 2004:13:13::2/96
Switch(config-if)# ipv6 router ospf 100 area 0 instance 0
Switch(config-if)# exit
```

Interface configuration for Switch2:

```
Switch(config)# interface eth-0-9
Switch(config-if)# no switchport
Switch(config-if)# no shutdown
Switch(config-if)# ipv6 address 2004:12:9::2/96
Switch(config-if)# ipv6 router ospf 200 area 0 instance 0
Switch(config-if)# exit

Switch(config)#interface eth-0-17
Switch(config-if)#no switchport
Switch(config-if)#no shutdown
Switch(config-if)# ipv6 address 2004:23:17::1/96
Switch(config-if)# ipv6 router ospf 200 area 0 instance 0
Switch(config-if)# exit
```

Interface configuration for Switch3:

```
Switch(config)# interface eth-0-9
Switch(config-if)# no switchport
Switch(config-if)# no shutdown
Switch(config-if)# ipv6 address 2004:4:100::1/96
Switch(config-if)# ipv6 router rip
Switch(config-if)# exit

Switch(config)# interface eth-0-13
Switch(config-if)# no switchport
Switch(config-if)# no shutdown
Switch(config-if)# ipv6 address 2004:13:13::2/96
Switch(config-if)# ipv6 router ospf 300 area 0 instance 0
Switch(config-if)# exit

Switch(config)# interface eth-0-17
Switch(config-if)# no switchport
Switch(config-if)# no shutdown
Switch(config-if)# ipv6 address 2004:23:17::2/96
Switch(config-if)# ipv6 router ospf 300 area 0 instance 0
Switch(config-if)# exit
```

Interface configuration for Switch4:

```
Switch(config)# interface eth-0-1
Switch(config-if)# no switchport
Switch(config-if)# no shutdown
Switch(config-if)# ipv6 address 2004:4:1::1/96
Switch(config-if)# ipv6 router rip
Switch(config-if)# exit

Switch(config)# interface eth-0-9
Switch(config-if)# no switchport
Switch(config-if)# no shutdown
Switch(config-if)# ipv6 address 2004:4:100::2/96
Switch(config-if)# ipv6 router rip
Switch(config-if)# exit
```

step 6 Exit the configure mode

```
Switch(config)# end
```

step 7 Validation

Display the result on Switch1:

```
Switch# show ipv6 route
IPv6 Routing Table
Codes: C - connected, S - static, R - RIP, I - IS-IS, B - BGP
       O - OSPF, IA - OSPF inter area
       N1 - OSPF NSSA external type 1, N2 - OSPF NSSA external type 2
       E1 - OSPF external type 1, E2 - OSPF external type 2
       Dr - DHCPV6 Relay
       [*] - [AD/Metric]
Timers: Uptime
O E2   2004:4:1::/96 [110/20]
       via fe80::c629:f2ff:fe02:3600, eth-0-13, 00:00:03
C      2004:12:9::/96
       via ::, eth-0-9, 00:34:20
C      2004:12:9::1/128
       via ::1, eth-0-9, 00:34:20
C      2004:13:13::/96
       via ::, eth-0-13, 00:34:19
C      2004:13:13::2/128
       via ::1, eth-0-13, 00:34:19
O      2004:23:17::/96 [110/2]
       via fe80::bc22:aeff:fe64:aa00, eth-0-9, 00:26:34
       via fe80::c629:f2ff:fe02:3600, eth-0-13, 00:26:34
C      fe80::/10
       via ::, Null0, 00:34:21

Switch# show ipv6 ospf database external
          OSPFv3 Router with ID (1.1.1.1) (Process 100)
          AS-external-LSA

LS age: 140
LS Type: AS-External-LSA
Link State ID: 0.0.0.1
Advertising Router: 3.3.3.3
LS Seq Number: 0x80000001
Checksum: 0x66F7
Length: 44
  Metric Type: 2 (Larger than any link state path)
  Metric: 20
  Prefix: 2004:4:1::/96
  Prefix Options: 0 (-|-|-)
  External Route Tag: 0
```

Display the result on Switch2:

```
Switch# show ipv6 route
IPv6 Routing Table
Codes: C - connected, S - static, R - RIP, I - IS-IS, B - BGP
```



```

O - OSPF, IA - OSPF inter area
N1 - OSPF NSSA external type 1, N2 - OSPF NSSA external type 2
E1 - OSPF external type 1, E2 - OSPF external type 2
Dr - DHCPV6 Relay
[*] - [AD/Metric]
Timers: Uptime
O E2    2004:4:1::/96 [110/20]
        via fe80::c629:f2ff:fe02:3600, eth-0-17, 00:02:43
C       2004:12:9::/96
        via ::, eth-0-9, 00:33:31
C       2004:12:9::2/128
        via ::1, eth-0-9, 00:33:31
O       2004:13:13::/96 [110/2]
        via fe80::b242:55ff:fe05:ff00, eth-0-9, 00:28:59
        via fe80::c629:f2ff:fe02:3600, eth-0-17, 00:28:59
C       2004:23:17::/96
        via ::, eth-0-17, 00:33:31
C       2004:23:17::1/128
        via ::1, eth-0-17, 00:33:31
C       fe80::/10
        via ::, Null0, 00:33:33

Switch# show ipv6 ospf database external
show ipv6 ospf database external
                OSPFv3 Router with ID (2.2.2.2) (Process 200)
                AS-external-LSA

LS age: 195
LS Type: AS-External-LSA
Link State ID: 0.0.0.1
Advertising Router: 3.3.3.3
LS Seq Number: 0x80000001
Checksum: 0x66F7
Length: 44
    Metric Type: 2 (Larger than any link state path)
    Metric: 20
    Prefix: 2004:4:1::/96
    Prefix Options: 0 (-|-|-|-)
    External Route Tag: 0

```

Display the result on Switch3:

```

Switch# show ipv6 route
IPv6 Routing Table
Codes: C - connected, S - static, R - RIP, I - IS-IS, B - BGP
O - OSPF, IA - OSPF inter area
N1 - OSPF NSSA external type 1, N2 - OSPF NSSA external type 2
E1 - OSPF external type 1, E2 - OSPF external type 2
Dr - DHCPV6 Relay
[*] - [AD/Metric]
Timers: Uptime
R       2004:4:1::/96 [120/2]
        via fe80::ee66:91ff:fe45:db00, eth-0-9, 00:03:43
C       2004:4:100::/96
        via ::, eth-0-9, 00:07:01
C       2004:4:100::1/128
        via ::1, eth-0-9, 00:07:01

```

```

O    2004:12:9::/96 [110/2]
    via fe80::b242:55ff:fe05:ff00, eth-0-13, 00:29:57
    via fe80::bc22:aeff:fe64:aa00, eth-0-17, 00:29:57
O    2004:13:13::/96 [110/1]
    via fe80::b242:55ff:fe05:ff00, eth-0-13, 00:30:12
C    2004:23:17::/96
    via ::, eth-0-17, 00:30:26
C    2004:23:17::2/128
    via ::1, eth-0-17, 00:30:26
C    fe80::/10
    via ::, Null0, 00:30:28

```

```

Switch# show ipv6 ospf database external
show ipv6 ospf database external
      OSPFv3 Router with ID (3.3.3.3) (Process 300)
      AS-external-LSA
      LS age: 250
      LS Type: AS-External-LSA
      Link State ID: 0.0.0.1
      Advertising Router: 3.3.3.3
      LS Seq Number: 0x80000001
      Checksum: 0x66F7
      Length: 44
      Metric Type: 2 (Larger than any link state path)
      Metric: 20
      Prefix: 2004:4:1::/96
      Prefix Options: 0 (-|-|-|-)
      External Route Tag: 0

```

Display the result on Switch4:

```

Switch# show ipv6 route
IPv6 Routing Table
Codes: C - connected, S - static, R - RIP, I - IS-IS, B - BGP
       O - OSPF, IA - OSPF inter area
       N1 - OSPF NSSA external type 1, N2 - OSPF NSSA external type 2
       E1 - OSPF external type 1, E2 - OSPF external type 2
       Dr - DHCPV6 Relay
       [*] - [AD/Metric]
Timers: Uptime
C    2004:4:1::/96
    via ::, eth-0-1, 00:04:48
C    2004:4:1::1/128
    via ::1, eth-0-1, 00:04:48
C    2004:4:100::/96
    via ::, eth-0-9, 00:06:59
C    2004:4:100::2/128
    via ::1, eth-0-9, 00:06:59
C    fe80::/10
    via ::, Null0, 00:07:00

```

Configure OSPFv3 Cost

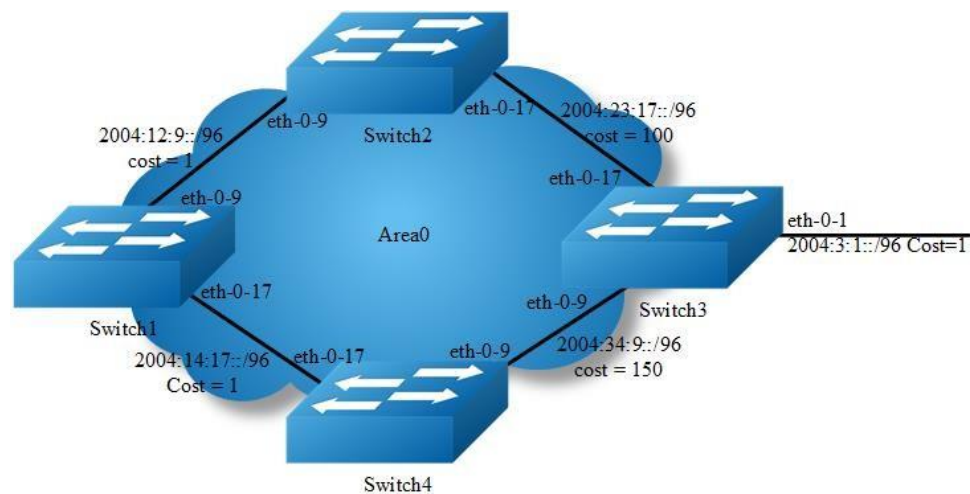

Figure 13-6 OSPFv3 Cost

You can make a route the preferred route by changing its cost. In this example, cost has been configured to make Switch2 the next hop for Switch1.

The default cost on each interface is 1(1000M speed). Interface eth2 on Switch2 has a cost of 100 and interface eth2 on Switch3 has a cost of 150. The total cost to reach(Switch4 network 10.10.14.0) through Switch2 and Switch3:

Switch2: $1+1+100 = 102$ Switch3: $1+1+150 = 152$

Therefore, Switch1 chooses Switch2 as its next hop for destination Switch4

step 1 Enter the configure mode

```
Switch# configure terminal
```

step 2 Enable ipv6 globally

```
Switch(config)# ipv6 enable
```

step 3 Create OSPFv3 instance

Configuring Switch1:

```
Switch(config)# router ipv6 ospf 100
Switch(config-router)# router-id 1.1.1.1
Switch(config-router)# exit
```

Configuring Switch2:

```
Switch(config)# router ipv6 ospf 200
Switch(config-router)# router-id 2.2.2.2
Switch(config-router)# exit
```

Configuring Switch3:

```
Switch(config)# router ipv6 ospf 300
Switch(config-router)# router-id 3.3.3.3
Switch(config-router)# exit
```

Configuring Switch4:

```
Switch(config)# router ipv6 ospf 400
Switch(config-router)# router-id 4.4.4.4
Switch(config-router)# exit
```

step 4 Enter the interface configure mode and set the attributes of the interface

Interface configuration for Switch1:

```
Switch(config)# interface eth-0-9
Switch(config-if)# no switchport
Switch(config-if)# no shutdown
Switch(config-if)# ipv6 address 2004:12:9::1/96
Switch(config-if)# ipv6 router ospf 100 area 0 instance 0
Switch(config-if)# exit

Switch(config)#interface eth-0-17
Switch(config-if)#no switchport
Switch(config-if)#no shutdown
Switch(config-if)# ipv6 address 2004:14:17::1/96
Switch(config-if)# ipv6 router ospf 100 area 0 instance 0
Switch(config-if)# exit
```

Interface configuration for Switch2:

```
Switch(config)# interface eth-0-9
Switch(config-if)# no switchport
Switch(config-if)# no shutdown
Switch(config-if)# ipv6 address 2004:12:9::2/96
Switch(config-if)# ipv6 router ospf 200 area 0 instance 0
Switch(config-if)# exit

Switch(config)#interface eth-0-17
Switch(config-if)#no switchport
Switch(config-if)#no shutdown
Switch(config-if)# ipv6 address 2004:23:17::1/96
Switch(config-if)# ipv6 router ospf 200 area 0 instance 0
Switch(config-if)# ipv6 ospf cost 100
Switch(config-if)# exit
```

Interface configuration for Switch3:

```
Switch(config)# interface eth-0-1
Switch(config-if)# no switchport
```

```
Switch(config-if)# no shutdown
Switch(config-if)# ipv6 address 2004:3:1::1/96
Switch(config-if)# ipv6 router ospf 300 area 0 instance 0
Switch(config-if)# exit

Switch(config)# interface eth-0-9
Switch(config-if)# no switchport
Switch(config-if)# no shutdown
Switch(config-if)# ipv6 address 2004:34:9::1/96
Switch(config-if)# ipv6 router ospf 300 area 0 instance 0
Switch(config-if)# exit

Switch(config)# interface eth-0-17
Switch(config-if)# no switchport
Switch(config-if)# no shutdown
Switch(config-if)# ipv6 address 2004:23:17::2/96
Switch(config-if)# ipv6 router ospf 300 area 0 instance 0
Switch(config-if)# exit
```

Interface configuration for Switch4:

```
Switch(config)# interface eth-0-9
Switch(config-if)# no switchport
Switch(config-if)# no shutdown
Switch(config-if)# ipv6 address 2004:34:9::2/96
Switch(config-if)# ipv6 router ospf 400 area 0 instance 0
Switch(config-if)# ipv6 ospf cost 150
Switch(config-if)# exit

Switch(config)# interface eth-0-17
Switch(config-if)# no switchport
Switch(config-if)# no shutdown
Switch(config-if)# ipv6 address 2004:14:17::2/96
Switch(config-if)# ipv6 router ospf 400 area 0 instance 0
Switch(config-if)# end
```

step 5 Exit the configure mode

```
Switch(config)# end
```

step 6 Validation

Display the result on Switch1:

```
Switch# show ipv6 ospf route
IPv6 Routing Table
Codes: C - connected, S - static, R - RIP, I - IS-IS, B - BGP
       O - OSPF, IA - OSPF inter area
       N1 - OSPF NSSA external type 1, N2 - OSPF NSSA external type 2
       E1 - OSPF external type 1, E2 - OSPF external type 2
       Dr - DHCPV6 Relay
       [*] - [AD/Metric]
Timers: Uptime
O       2004:3:1::/96 [110/102]
```

```

via fe80::bc22:aeff:fe64:aa00, eth-0-9, 00:08:06
C    2004:12:9::/96
via ::, eth-0-9, 01:15:43
C    2004:12:9::1/128
via ::1, eth-0-9, 01:15:43
C    2004:14:17::/96
via ::, eth-0-17, 00:18:38
C    2004:14:17::1/128
via ::1, eth-0-17, 00:18:38
O    2004:23:17::/96 [110/101]
via fe80::bc22:aeff:fe64:aa00, eth-0-9, 00:08:06
O    2004:34:9::/96 [110/102]
via fe80::bc22:aeff:fe64:aa00, eth-0-9, 00:03:56
C    fe80::/10
via ::, Null10, 01:15:44

```

Display the result on Switch2:

```

Switch# show ipv6 ospf route
IPv6 Routing Table
Codes: C - connected, S - static, R - RIP, I - IS-IS, B - BGP
       O - OSPF, IA - OSPF inter area
       N1 - OSPF NSSA external type 1, N2 - OSPF NSSA external type 2
       E1 - OSPF external type 1, E2 - OSPF external type 2
       Dr - DHCPV6 Relay
       [*] - [AD/Metric]
Timers: Uptime
O    2004:3:1::/96 [110/101]
    via fe80::c629:f2ff:fe02:3600, eth-0-17, 00:08:33
C    2004:12:9::/96
    via ::, eth-0-9, 01:12:40
C    2004:12:9::2/128
    via ::1, eth-0-9, 01:12:40
O    2004:14:17::/96 [110/2]
    via fe80::b242:55ff:fe05:ff00, eth-0-9, 00:18:43
C    2004:23:17::/96
    via ::, eth-0-17, 01:12:40
C    2004:23:17::1/128
    via ::1, eth-0-17, 01:12:40
O    2004:34:9::/96 [110/101]
    via fe80::c629:f2ff:fe02:3600, eth-0-17, 00:04:23
C    fe80::/10
    via ::, Null10, 01:12:42

```

Display the result on Switch3:

```

Switch# show ipv6 ospf route
IPv6 Routing Table
Codes: C - connected, S - static, R - RIP, I - IS-IS, B - BGP
       O - OSPF, IA - OSPF inter area
       N1 - OSPF NSSA external type 1, N2 - OSPF NSSA external type 2
       E1 - OSPF external type 1, E2 - OSPF external type 2
       Dr - DHCPV6 Relay
       [*] - [AD/Metric]
Timers: Uptime
C    2004:3:1::/96

```

```

via ::, eth-0-1, 00:13:54
C    2004:3:1::1/128
via ::1, eth-0-1, 00:13:54
O    2004:12:9::/96 [110/2]
via fe80::bc22:aeff:fe64:aa00, eth-0-17, 00:19:47
O    2004:14:17::/96 [110/2]
via fe80::ee66:91ff:fe45:db00, eth-0-9, 00:02:27
C    2004:23:17::/96
via ::, eth-0-17, 01:09:02
C    2004:23:17::2/128
via ::1, eth-0-17, 01:09:02
C    2004:34:9::/96
via ::, eth-0-9, 00:04:52
C    2004:34:9::1/128
via ::1, eth-0-9, 00:04:52
C    fe80::/10
via ::, Null10, 01:09:04

```

Display the result on Switch4:

```

Switch# show ipv6 route
IPv6 Routing Table
Codes: C - connected, S - static, R - RIP, I - IS-IS, B - BGP
       O - OSPF, IA - OSPF inter area
       N1 - OSPF NSSA external type 1, N2 - OSPF NSSA external type 2
       E1 - OSPF external type 1, E2 - OSPF external type 2
       Dr - DHCPV6 Relay
       [*] - [AD/Metric]
Timers: Uptime
O    2004:3:1::/96 [110/103]
via fe80::b242:55ff:fe05:ff00, eth-0-17, 00:02:35
O    2004:12:9::/96 [110/2]
via fe80::b242:55ff:fe05:ff00, eth-0-17, 00:02:35
C    2004:14:17::/96
via ::, eth-0-17, 00:04:09
C    2004:14:17::2/128
via ::1, eth-0-17, 00:04:09
O    2004:23:17::/96 [110/102]
via fe80::b242:55ff:fe05:ff00, eth-0-17, 00:02:35
C    2004:34:9::/96
via ::, eth-0-9, 00:06:06
C    2004:34:9::2/128
via ::1, eth-0-9, 00:06:06
C    fe80::/10
via ::, Null10, 00:44:59

```

Monitoring OSPFv3

You can display specific statistics such as the contents of IPv6 routing tables, caches, and databases.

Display general information about OSPFv3 routing processes

```
Switch# show ipv6 ospf
Routing Process "OSPFv3 (300)" with ID 3.3.3.3
Process uptime is 3 hours 23 minutes
SPF schedule delay min 0.500 secs, SPF schedule delay max 50.0 secs
Minimum LSA interval 5 secs, Minimum LSA arrival 1 secs
Number of incoming current DD exchange neighbors 0/5
Number of outgoing current DD exchange neighbors 0/5
Number of external LSA 0. Checksum Sum 0x0000
Number of AS-Scoped Unknown LSA 0
Number of LSA originated 6
Number of LSA received 43
Number of areas in this router is 1
  Area BACKBONE(0)
    Number of interfaces in this area is 1(1)
    SPF algorithm executed 14 times
    Number of LSA 5. Checksum Sum 0x30DCD
    Number of Unknown LSA 0
```

Display lists of information related to the OSPFv3 database

```
Switch# show ipv6 ospf database database-summary

                OSPFv3 Router with ID (3.3.3.3) (Process ID 300)
Area (0.0.0.0) database summary
  LSA Type          Count          MaxAge
  Router             3              0
  Network            1              0
  Inter-Prefix       0              0
  Inter-Router       0              0
  Intra-Prefix       1              0
  Subtotal           5              0

Process 300 database summary
  LSA Type          Count          MaxAge
  Router             3              0
  Network            1              0
  Inter-Prefix       0              0
  Inter-Router       0              0
  Type-5 Ext         0              0
  Link               3              0
  Intra-Prefix       1              0
  Total              8              0

Switch# show ipv6 ospf database router

                OSPFv3 Router with ID (3.3.3.3) (Process 300)

                Router-LSA (Area 0.0.0.0)

LS age: 600
LS Type: Router-LSA
Link State ID: 0.0.0.0
```



```
Advertising Router: 1.1.1.1
LS Seq Number: 0x80000008
Checksum: 0x9A57
Length: 40
Flags: 0x00 (-|-|-|-|-)
Options: 0x000013 (-|R|-|-|E|V6)

Link connected to: a Transit Network
Metric: 1
Interface ID: 9
Neighbor Interface ID: 13
Neighbor Router ID: 3.3.3.3

LS age: 597
LS Type: Router-LSA
Link State ID: 0.0.0.0
Advertising Router: 2.2.2.2
LS Seq Number: 0x8000000D
Checksum: 0xE2FD
Length: 40
Flags: 0x00 (-|-|-|-|-)
Options: 0x000013 (-|R|-|-|E|V6)

Link connected to: a Transit Network
Metric: 1
Interface ID: 17
Neighbor Interface ID: 13
Neighbor Router ID: 3.3.3.3

LS age: 599
LS Type: Router-LSA
Link State ID: 0.0.0.0
Advertising Router: 3.3.3.3
LS Seq Number: 0x8000000C
Length: 40
Flags: 0x00 (-|-|-|-|-)
Options: 0x000013 (-|R|-|-|E|V6)

Link connected to: a Transit Network
Metric: 1
Interface ID: 13
Neighbor Interface ID: 13
Neighbor Router ID: 3.3.3.3

Switch# show ipv6 ospf database network self-originate

OSPFv3 Router with ID (3.3.3.3) (Process 300)

Network-LSA (Area 0.0.0.0)

LS age: 1261
```

```
LS Type: Network-LSA
Link State ID: 0.0.0.13
Advertising Router: 3.3.3.3
LS Seq Number: 0x80000004
Checksum: 0x727E
Length: 36
Options: 0x000013 (-|R|-|-|E|V6)
  Attached Router: 3.3.3.3
  Attached Router: 1.1.1.1
  Attached Router: 2.2.2.2

Switch# show ipv6 ospf database inter-router

      OSPFv3 Router with ID (3.3.3.3) (Process 300)

Switch# show ipv6 ospf database intra-prefix

      OSPFv3 Router with ID (3.3.3.3) (Process 300)

      Intra-Area-Prefix-LSA (Area 0.0.0.0)

LS age: 1623
LS Type: Intra-Area-Prefix-LSA
Link State ID: 0.0.0.2
Advertising Router: 3.3.3.3
LS Seq Number: 0x80000004
Checksum: 0x8FA8
Length: 48
Number of Prefixes: 1
Referenced LS Type: 0x2002
Referenced Link State ID: 0.0.0.13
Referenced Advertising Router: 3.3.3.3

  Prefix: 2004:12:9::/96
  Prefix Options: 0 (-|-|-|-)
  Metric: 0

Switch# show ipv6 ospf database inter-prefix

      OSPFv3 Router with ID (3.3.3.3) (Process 300)

Switch# show ipv6 ospf database link

      OSPFv3 Router with ID (3.3.3.3) (Process 300)

      Link-LSA (Interface eth-0-13)

LS age: 641
LS Type: Link-LSA
Link State ID: 0.0.0.9
Advertising Router: 1.1.1.1
LS Seq Number: 0x80000005
Checksum: 0x9C1C
```

```

Length: 60
Priority: 1
Options: 0x000013 (-|R|-|-|E|V6)
Link-Local Address: fe80::20e6:7eff:fee2:d400
Number of Prefixes: 1

    Prefix: 2004:12:9::/96
    Prefix Options: 0 (-|-|-|-)

LS age: 698
LS Type: Link-LSA
Link State ID: 0.0.0.17
Advertising Router: 2.2.2.2
LS Seq Number: 0x80000008
Checksum: 0x2159
Length: 60
Priority: 1
Options: 0x000013 (-|R|-|-|E|V6)
Link-Local Address: fe80::fcc8:7bff:fe3e:ec00
Number of Prefixes: 1

    Prefix: 2004:12:9::/96
    Prefix Options: 0 (-|-|-|-)

LS age: 1535
LS Type: Link-LSA
Link State ID: 0.0.0.13
Advertising Router: 3.3.3.3
LS Seq Number: 0x80000008
Checksum: 0x6E9A
Length: 60
Priority: 10
Options: 0x000013 (-|R|-|-|E|V6)
Link-Local Address: fe80::ba5d:79ff:fe55:ed00
Number of Prefixes: 1

    Prefix: 2004:12:9::/96
    Prefix Options: 0 (-|-|-|-)

Switch# show ipv6 ospf database external

                                OSPFv3 Router with ID (3.3.3.3) (Process 300)

```

Display OSPFv3-related interface information

```

Switch# show ipv6 ospf interface
eth-0-13 is up, line protocol is up
    Interface ID 13
    IPv6 Prefixes
        fe80::ba5d:79ff:fe55:ed00/10 (Link-Local Address)

```

```

2004:12:9::3/96
OSPFv3 Process (300), Area 0.0.0.0, Instance ID 0
Router ID 3.3.3.3, Network Type BROADCAST, Cost: 1
Transmit Delay is 1 sec, State DR, Priority 10
Designated Router (ID) 3.3.3.3
  Interface Address fe80::ba5d:79ff:fe55:ed00
Backup Designated Router (ID) 2.2.2.2
  Interface Address fe80::fcc8:7bff:fe3e:ec00
Timer interval configured, Hello 10, Dead 40, Wait 40, Retransmit 5
Hello due in 00:00:01
Neighbor Count is 2, Adjacent neighbor count is 2

```

Display OSPFv3 interface neighbor information

```

Switch# show ipv6 ospf neighbor
OSPFv3 Process (300)
Neighbor ID      Pri   State           Dead Time   Interface   Instance ID
1.1.1.1          1    Full/DROther    00:00:39   eth-0-13    0
2.2.2.2          1    Full/Backup     00:00:33   eth-0-13    0

```

13.2.3 Application cases

N/A

13.3 Configuring RIPng

13.3.1 Overview

Function Introduction

Routing Information Protocol Next Generation (RIPng) is an IPv6 route exchange protocol that uses a distance vector (a number representing distance) to measure the cost of a given route. The cost is a distance vector because the cost is often equivalent to the number of router hops between the source and the destination networks. RIPng can receive multiple paths to a destination. The system evaluates the paths, selects the best path, and saves the path in the IPv6 route table as the route to the destination.

Typically, the best path is the path with the fewest hops. A hop is another router through which packets must travel to reach the destination. If RIPng receives a RIPng update from another router that contains a path with fewer hops than the path stored in the route table, the system replaces the older route with the newer one. The system then includes the new path in the updates it sends to other RIPng routers.

RIPng routers also can modify a route's cost, generally by adding to it, to bias the selection of a route for a given destination. In this case, the actual number of router hops may be the same, but the route has an administratively higher cost and is thus less likely to be used than other, lower-cost routes. A RIPng route can have a maximum cost of 15. Any destination with a higher cost is considered unreachable. Although limiting to larger networks, the low maximum hop count prevents endless loops in the network.

This chapter contains basic RIPng configuration examples. To see details on the commands used in these examples, or to see the outputs of the Validation commands, refer to the RIPng Command Reference. To avoid repetition, some Common commands, like `configure terminal`, have not been listed under the Commands Used section.

There are some differences between RIPng and RIP:

- UDP port number: RIPng uses UDP port number 521 to send or receive package.
- Multicast address: RIPng uses FF02::9 to multicast package to other routers of link local.
- Nexthop address: RIPng uses 128 bit ipv6 address.
- Source address: RIPng uses IPv6 link-local address FE80::/10 to be the source address when updating package to neighbor.

Principle Description

The RIPng module is based on the following RFC: RFC 2080 - RIPng for IPv6

13.3.2 Configuration

Enabling RIPng

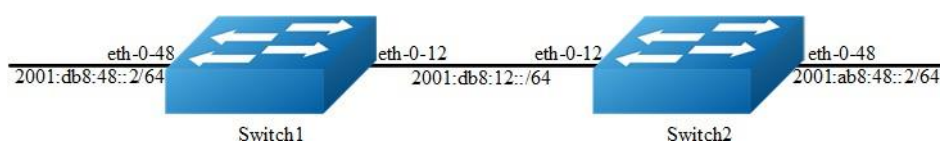

Figure 13-7 RIPng

This example shows how to enable RIPng protocols on two switches:

The following configuration should be operated on all switches if the switch ID is not specified.

step 1 Enter the configure mode

```
Switch# configure terminal
```

step 2 Enable ipv6 globally

```
Switch(config)# ipv6 enable
```

step 3 Enter the interface configure mode and set the attributes of the interface

Interface configuration for Switch1:

```
Switch(config)# interface eth-0-12
Switch(config-if)# no switchport
Switch(config-if)# no shutdown
Switch(config-if)# ipv6 address 2001:db8:12::1/64
Switch(config-if)# ipv6 router rip
Switch(config-if)# exit

Switch(config)# interface eth-0-48
Switch(config-if)# no switchport
Switch(config-if)# no shutdown
Switch(config-if)# ipv6 address 2001:db8:48::2/64
Switch(config-if)# ipv6 router rip
Switch(config-if)# exit
```

Interface configuration for Switch2:

```
Switch(config)# interface eth-0-12
Switch(config-if)# no switchport
Switch(config-if)# no shutdown
Switch(config-if)# ipv6 address 2001:db8:12::2/64
Switch(config-if)# ipv6 router rip
Switch(config-if)# exit

Switch(config)# interface eth-0-48
Switch(config-if)# no switchport
Switch(config-if)# no shutdown
Switch(config-if)# ipv6 address 2001:ab8:49::2/64
Switch(config-if)# ipv6 router rip
Switch(config-if)# exit
```

step 4 Exit the configure mode

```
Switch(config)# end
```

step 5 Validation

Display the result on Switch1:

```
Switch# show ipv6 rip database
Codes: R - RIP, Rc - RIP connected, Rs - RIP static, Ra - RIP aggregated,
      Rcx - RIP connect suppressed, Rsx - RIP static suppressed,
      K - Kernel, C - Connected, S - Static, O - OSPF, I - IS-IS, B - BGP
  Network                Next Hop                If      Met Tag Time
R 2001:ab8:49::/64      fe80::1271:d1ff:fec8:3300 eth-0-12 5    0   00:02:34
Rc 2001:db8:12::/64      ::                      eth-0-12 1    0
Rc 2001:db8:48::/64      ::                      eth-0-48 1    0

Switch# show ipv6 rip interface
eth-0-12 is up, line protocol is up
  Routing Protocol: RIPng
  Passive interface: Disabled
  Split horizon: Enabled with Poisoned Reversed
  IPv6 interface address:
    2001:db8:12::1/64
    fe80::7e14:63ff:fe76:8900/10
eth-0-48 is up, line protocol is up
  Routing Protocol: RIPng
  Passive interface: Disabled
  Split horizon: Enabled with Poisoned Reversed
  IPv6 interface address:
    2001:db8:48::2/64
    fe80::7e14:63ff:fe76:8900/10

Switch# show ipv6 protocols rip
Routing Protocol is "ripng"
  Sending updates every 30 seconds with +/-5 seconds, next due in 7 seconds
  Timeout after 180 seconds, garbage collect after 120 seconds
  Outgoing update filter list for all interface is not set
  Incoming update filter list for all interface is not set
  Default redistribute metric is 1
  Redistributing:
  Interface
    eth-0-12
    eth-0-48
  Routing for Networks:
  Number of routes (including connected): 3
  Distance: (default is 120)

Switch# show ipv6 route rip
IPv6 Routing Table
Codes: C - connected, S - static, R - RIP, I - IS-IS, B - BGP
      O - OSPF, IA - OSPF inter area
      N1 - OSPF NSSA external type 1, N2 - OSPF NSSA external type 2
      E1 - OSPF external type 1, E2 - OSPF external type 2
      Dr - DHCPV6 Relay
      [*] - [AD/Metric]
Timers: Uptime
R      2001:ab8:49::/64 [120/5]
      via fe80::1271:d1ff:fec8:3300, eth-0-12, 00:26:05
```

Display the result on Switch2:

```
Switch# show ipv6 rip database
Codes: R - RIP, Rc - RIP connected, Rs - RIP static, Ra - RIP aggregated,
       Rcx - RIP connect suppressed, Rsx - RIP static suppressed,
       K - Kernel, C - Connected, S - Static, O - OSPF, I - IS-IS, B - BGP
   Network                               Next Hop                               If      Met Tag Time
Rc 2001:ab8:49::/64                       ::                                       eth-0-48 1   0
Rc 2001:db8:12::/64                       ::                                       eth-0-12 1   0
R   2001:db8:48::/64                       fe80::7e14:63ff:fe76:8900 eth-0-12 2   0   00:02:33

Switch# show ipv6 rip interface
eth-0-12 is up, line protocol is up
  Routing Protocol: RIPng
    Passive interface: Disabled
    Split horizon: Enabled with Poisoned Reversed
    IPv6 interface address:
      2001:db8:12::2/64
      fe80::1271:d1ff:fec8:3300/10
eth-0-48 is up, line protocol is up
  Routing Protocol: RIPng
    Passive interface: Disabled
    Split horizon: Enabled with Poisoned Reversed
    IPv6 interface address:
      2001:ab8:49::2/64
      fe80::1271:d1ff:fec8:3300/10

Switch# show ipv6 protocols rip
Routing Protocol is "ripng"
  Sending updates every 30 seconds with +/-5 seconds, next due in 13 seconds
  Timeout after 180 seconds, garbage collect after 120 seconds
  Outgoing update filter list for all interface is not set
  Incoming update filter list for all interface is not set
  Outgoing routes will have 3 added to metric if on list ripng_acl
  Default redistribute metric is 1
  Redistributing:
  Interface
    eth-0-12
    eth-0-48
  Routing for Networks:
  Number of routes (including connected): 3
  Distance: (default is 120)

Switch# show ipv6 route rip
IPv6 Routing Table
Codes: C - connected, S - static, R - RIP, I - IS-IS, B - BGP
       O - OSPF, IA - OSPF inter area
       N1 - OSPF NSSA external type 1, N2 - OSPF NSSA external type 2
       E1 - OSPF external type 1, E2 - OSPF external type 2
       Dr - DHCPV6 Relay
       [*] - [AD/Metric]
Timers: Uptime
R      2001:db8:48::/64 [120/2]
      via fe80::7e14:63ff:fe76:8900, eth-0-12, 00:23:31
```

Configuring Metric Parameters

A RIPng offset list allows you to add to the metric of specific inbound or outbound routes learned or advertised by RIPng. RIPng offset lists provide a simple method for adding to the cost of specific routes and therefore biasing the router's route selection away from those routes. An offset list consists of the following parameters:

- An ACL that specifies the routes to which to add the metric.
- In: applies to routes the router learns from RIPng neighbors.
- Out: applies to routes the router is advertising to its RIPng neighbors.
- The offset value that will be added to the routing metric of the routes that match the ACL.
- The interface that the offset list applies (optional).

If a route matches both a global offset list (without specified interface) and an interface-based offset list, the interface-based offset list takes precedence. The interface-based offset list's metric is added to the route in this case.

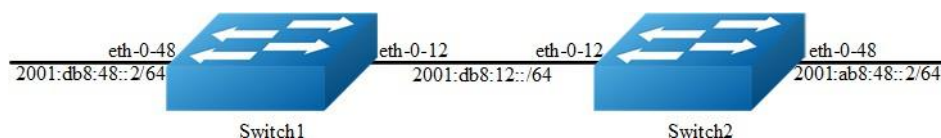

Figure 13-8 RIPng Metric

This example Switch 1 will advertise route 2001:db8:48::2/64 out of interface eth-0-12 with metric 3.

step 1 Check the current configuration

Current configuration of Switch1:

```
Switch# show running-config
!
ipv6 enable
!
Switch# show run
interface eth-0-12
  no switchport
  ipv6 address auto link-local
  ipv6 address 2001:db8:12::1/64
  ipv6 router rip
!
interface eth-0-48
```

```
no switchport
ipv6 nd ra mtu suppress
ipv6 address auto link-local
ipv6 address 2001:db8:48::2/64
ipv6 router rip
!
router ipv6 rip
!
```

Current configuration of Switch2:

```
Switch# show running-config
!
ipv6 enable
!
interface eth-0-12
no switchport
ipv6 address auto link-local
ipv6 address 2001:db8:12::2/64
ipv6 router rip
!
interface eth-0-48
no switchport
ipv6 nd ra mtu suppress
ipv6 address auto link-local
ipv6 address 2001:ab8:48::2/64
ipv6 router rip
!
router ipv6 rip
!
```

Check the RIPng states on Switch2:

```
Switch# show ipv6 route rip
R      2001:db8:48::/64 [120/2]
      via fe80::7e14:63ff:fe76:8900, eth-0-12, 00:44:47
```

The following configurations are operated on Switch1:

step 2 Enter the configure mode

```
Switch# configure terminal
```

step 3 Create access list

```
Switch(config)#ipv6 access-list ripngoffset
Switch(config-ipv6-acl)# permit any 2001:db8:48::/64 any
Switch(config-ipv6-acl)# exit
```

step 4 Apply the access list

```
Switch(config)# router ipv6 rip
Switch(config-router)# offset-list ripngoffset out 3 eth-0-12
Switch(config-router)# exit
```

step 5 Exit the configure mode

```
Switch(config)# end
```

step 6 Validation

Display the result on Switch2:

```
Switch# show ipv6 route rip
R      2001:db8:48::/64 [120/5]
      via fe80::7e14:63ff:fe76:8900, eth-0-12, 00:00:07
```

Configuring the Administrative Distance

By default, RIPng assigns the default RIPng administrative distance (120) to RIPng routes. When comparing routes based on administrative distance, the router selects the route with the lower distance. You can change the administrative distance for RIPng routes.

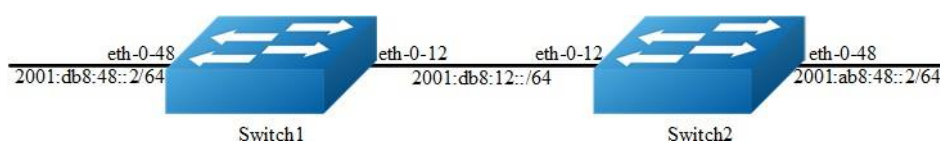

Figure 13-9 RIPng Distance

This example shows how to change the RIPng administrative distance.

step 1 Check the current configuration

Current configuration of Switch1:

```
Switch# show running-config
!
ipv6 enable
!
interface eth-0-12
 no switchport
 ipv6 address auto link-local
 ipv6 address 2001:db8:12::1/64
 ipv6 router rip
```

```
!  
interface eth-0-48  
  no switchport  
  ipv6 nd ra mtu suppress  
  ipv6 address auto link-local  
  ipv6 address 2001:db8:48::2/64  
  ipv6 router rip  
!  
router ipv6 rip  
!
```

Current configuration of Switch2:

```
Switch# show running-config  
!  
ipv6 enable  
!  
interface eth-0-12  
  no switchport  
  ipv6 address auto link-local  
  ipv6 address 2001:db8:12::2/64  
  ipv6 router rip  
!  
interface eth-0-48  
  no switchport  
  ipv6 nd ra mtu suppress  
  ipv6 address auto link-local  
  ipv6 address 2001:ab8:48::2/64  
  ipv6 router rip  
!  
router ipv6 rip  
!
```

Check the RIPng states on Switch2:

```
Switch# show ipv6 route rip  
R      2001:db8:48::/64 [120/2]  
      via fe80::7e14:63ff:fe76:8900, eth-0-12, 00:44:47
```

The following configurations are operated on Switch2:

step 2 Enter the configure mode

```
Switch# configure terminal
```

step 3 Change the administrative distance

```
Switch(config)# router ipv6 rip  
Switch(config-router)# distance 100  
Switch(config-router)# exit
```

step 4 Exit the configure mode

```
Switch(config)# end
```

step 4 Validation

Display the result on Switch2:

```
Switch# show ipv6 route rip
R      2001:db8:48::/64 [100/5]
      via fe80::7e14:63ff:fe76:8900, eth-0-12, 00:00:09
```

Configuring Redistribution

You can configure the router to redistribute static routes, direct connected routes or routes learned through Open Shortest Path First (OSPF) into RIPng. When you redistribute a route from one of these other protocols into RIPng, the router can use RIPng to advertise the route to its RIPng neighbors.

Change the default redistribution metric (optional). The router assigns a RIPng metric of 1 to each redistributed route by default. You can change the default metric to a value up to 16.

Enable specified routes to redistribute with default or specified metric.

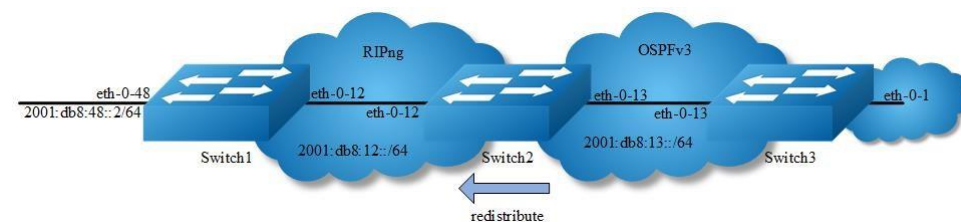

Figure 13-10 RIPng redistribute

This example shows how to redistribute other protocols into RIPng.

step 1 Check the current configuration

Current configuration of Switch1:

```
Switch# show running-config
!
ipv6 enable
!
interface eth-0-12
no switchport
```

```
ipv6 address auto link-local
ipv6 address 2001:db8:12::1/64
ipv6 router rip
!
interface eth-0-48
no switchport
ipv6 nd ra mtu suppress
ipv6 address auto link-local
ipv6 address 2001:db8:48::2/64
ipv6 router rip
!
router ipv6 rip
!
```

Current configuration of Switch2:

```
Switch# show running-config
!
ipv6 enable
!
interface eth-0-12
no switchport
ipv6 address auto link-local
ipv6 address 2001:db8:12::2/64
ipv6 router rip
!
interface eth-0-13
no switchport
ipv6 address auto link-local
ipv6 address 2001:db8:13::1/64
ipv6 router ospf area 0
!
interface eth-0-48
no switchport
ipv6 nd ra mtu suppress
ipv6 address auto link-local
ipv6 address 2001:ab8:48::2/64
ipv6 router rip
!
router ipv6 rip
!
router ipv6 ospf
router-id 1.1.1.1
```

Current configuration of Switch3:

```
Switch# show running-config
!
ipv6 enable
!
interface eth-0-1
no switchport
ipv6 address auto link-local
ipv6 address 2001:db8:1::1/64
ipv6 router ospf area 0
!
```

```
interface eth-0-13
  no switchport
  ipv6 address 2001:db8:13::2/64
  ipv6 router ospf area 0
!
router ipv6 ospf
  router-id 2.2.2.2
!
```

Check the RIPng states on Switch1:

```
Switch# show ipv6 route rip
R      2001:ab8:48::/64 [120/5]
      via fe80::1271:d1ff:fec8:3300, eth-0-12, 01:43:37
```

Check the RIPng states on Switch2:

```
Switch# show ipv6 route
O      2001:db8:1::/64 [110/2]
      via fe80::5c37:1dff:febe:2d00, eth-0-13, 00:31:17
R      2001:db8:48::/64 [100/5]
      via fe80::7e14:63ff:fe76:8900, eth-0-12, 00:49:57
```

The following configurations are operated on Switch2:

step 2 Enter the configure mode

```
Switch# configure terminal
```

step 3 Enable redistribute, and et the default metric and redistribute metric

```
Switch(config)# router ipv6 rip
Switch(config-router)# default-metric 2
Switch(config-router)# redistribute ospfv3 metric 5
Switch(config-router)# exit
```

step 4 Exit the configure mode

```
Switch(config)# end
```

step 5 Validation

Display the result on Switch1:

```
Switch# show ipv6 route rip
R      2001:ab8:48::/64 [120/5]
      via fe80::1271:d1ff:fec8:3300, eth-0-12, 01:48:23
R      2001:db8:1::/64 [120/6]
      via fe80::1271:d1ff:fec8:3300, eth-0-12, 00:00:19
```

Configuring Split-horizon Parameters

Normally, routers that are connected to multicast-type IPv6 networks and that use distance-vector routing protocols employ the split horizon mechanism to reduce the possibility of routing loops. Split horizon blocks information about routes from being advertised by a router out of any interface from which that information originated. This behavior usually optimizes communications among multiple routers, particularly when links are broken. However, with non-multicast networks (such as Frame Relay), situations can arise for which this behavior is less than ideal. For these situations, you might want to disable split horizon for RIPng.

You can avoid including routes in updates sent to the same gateway from which they were learned. Using the split horizon command omits routes learned from one neighbor, in updates sent to that neighbor. Using the poisoned parameter with this command includes such routes in updates, but sets their metrics to infinity. Thus, advertising these routes means that they are not reachable.

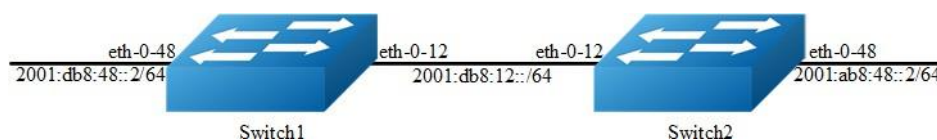

Figure 13-11 RIPng Split-horizon

step 1 Check the current configuration

Current configuration of Switch1:

```
Switch# show running-config
!
ipv6 enable
!
interface eth-0-12
no switchport
ipv6 address auto link-local
ipv6 address 2001:db8:12::1/64
ipv6 router rip
!
interface eth-0-48
no switchport
ipv6 nd ra mtu suppress
ipv6 address auto link-local
ipv6 address 2001:db8:48::2/64
ipv6 router rip
!
```



```
router ipv6 rip
!
```

Current configuration of Switch2:

```
Switch# show running-config
!
ipv6 enable
!
interface eth-0-12
 no switchport
 ipv6 address auto link-local
 ipv6 address 2001:db8:12::2/64
 ipv6 router rip
!
interface eth-0-48
 no switchport
 ipv6 nd ra mtu suppress
 ipv6 address auto link-local
 ipv6 address 2001:ab8:48::2/64
 ipv6 router rip
!
router ipv6 rip
!
```

Enable debug on switch2

```
Switch# debug ipv6 rip packet send detail
Switch# terminal monitor
```

The following configurations are operated on Switch2:

step 2 Enter the configure mode

```
Switch# configure terminal
```

step 3 Set the split-horizon on interface configure mode

Disable split-horizon:

```
Switch(config)#interface eth-0-12
Switch(config-if)# no ipv6 rip split-horizon
Switch(config-if)# exit
```

System debug information:

```
Oct 24 10:00:06 Switch RIPNG6-7: SEND[eth-0-12]: Send to [ff02::9]:521
Oct 24 10:00:06 Switch RIPNG6-7: SEND[eth-0-12]: RESPONSE version 1 packet size 64
Oct 24 10:00:06 Switch RIPNG6-7: 2001:ab8:49::/64 metric 4 tag 0
Oct 24 10:00:06 Switch RIPNG6-7: 2001:db8:12::/64 metric 1 tag 0
Oct 24 10:00:06 Switch RIPNG6-7: 2001:db8:48::/64 metric 5 tag 0
```

Enable split-horizon:

```
Switch(config)#interface eth-0-12
Switch(config-if)# ipv6 rip split-horizon
Switch(config-if)# exit
```

System debug information:

```
Oct 24 10:05:16 Switch RIPNG6-7: SEND[eth-0-12]: Send to [ff02::9]:521
Oct 24 10:05:16 Switch RIPNG6-7: SEND[eth-0-12]: RESPONSE version 1 packet size 44
Oct 24 10:05:16 Switch RIPNG6-7: 2001:ab8:49::/64 metric 4 tag 0
Oct 24 10:05:16 Switch RIPNG6-7: 2001:db8:12::/64 metric 1 tag 0
```

step 3 Exit the configure mode

```
Switch(config)# end
```

step 4 Validation

```
Switch# show ipv6 rip interface
eth-0-12 is up, line protocol is up
  Routing Protocol: RIPng
    Passive interface: Disabled
    Split horizon: Disabled
  IPv6 interface address:
    2001:ab8:48::2/64
    2001:db8:12::2/64
    fe80::7eff:80ff:fef4:ff00/10
```

Configuring Timers

RIPng use several timers that determine such variables as the frequency of routing updates, the length of time before a route becomes invalid, and other parameters. You can adjust these timers to tune RIPng performance to better suit your internet-work needs. You can make the following timer adjustments:

- The rate (time in seconds between updates) at which routing updates are sent.
- The interval of time (in seconds) after which a route is declared invalid.
- The amount of time (in seconds) that must pass before a route is removed from the routing table.

To configure the timers, use the following command:

step 1 Enter the configure mode

```
Switch# configure terminal
```

step 2 Set the timers

Set the routing table update timer to 10 seconds. Set the routing information timeout timer to 180 seconds. Set the routing garbage collection timer to 120 seconds.

```
Switch(config)# router ipv6 rip
Switch(config-router)# timers basic 10 180 120
Switch(config-router)# exit
```

step 3 Exit the configure mode

```
Switch(config)# end
```

step 4 Validation

Use the commands as follows to validate the configuration:

```
Switch# show ipv6 protocols rip
Routing Protocol is "ripng"
  Sending updates every 10 seconds with +/-5 seconds, next due in 5 seconds
  Timeout after 180 seconds, garbage collect after 120 seconds
  Outgoing update filter list for all interface is not set
  Incoming update filter list for all interface is not set
  Outgoing routes will have 3 added to metric if on list ripng_acl
  Default redistribute metric is 2
  Redistributing:
  Interface
    eth-0-12
    eth-0-48
  Routing for Networks:
  Number of routes (including connected): 3
  Distance: (default is 100)
```

Configuring RIPng Route Distribute Filters

A RIP distribute list allows you to permit or deny learning or advertising of specific routes. A distribute list consists of the following parameters:

- An ACL or a prefix list that filter the routes.
- In: filter applies to learned routes.
- Out: filter applies to advertised routes
- The interface that the filter applies (optional).

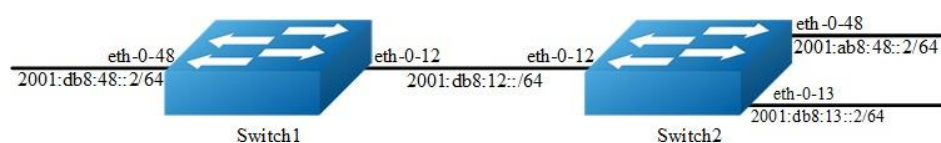

Figure 13-12 RIPng Route Distribute Filters**step 1** Check the current configuration

Current configuration of Switch1:

```
Switch# show running-config
!
ipv6 enable
!
interface eth-0-12
  no switchport
  ipv6 address auto link-local
  ipv6 address 2001:db8:12::1/64
  ipv6 router rip
!
interface eth-0-48
  no switchport
  ipv6 nd ra mtu suppress
  ipv6 address auto link-local
  ipv6 address 2001:db8:48::2/64
  ipv6 router rip
!
router ipv6 rip
!
```

Current configuration of Switch2:

```
Switch# show running-config
!
ipv6 enable
!
interface eth-0-12
  no switchport
  ipv6 address auto link-local
  ipv6 address 2001:db8:12::2/64
  ipv6 router rip
!
interface eth-0-13
  no switchport
  ipv6 address auto link-local
  ipv6 address 2001:db8:13::1/64
  ipv6 router rip
!
interface eth-0-48
  no switchport
  ipv6 nd ra mtu suppress
  ipv6 address auto link-local
  ipv6 address 2001:ab8:48::2/64
  ipv6 router rip
!
router ipv6 rip
!
```

Check the RIPng states on Switch1:

```
Switch# show ipv6 route rip
R      2001:ab8:48::/64 [120/5]
      via fe80::1271:d1ff:fec8:3300, eth-0-12, 00:18:29
R      2001:db8:13::/64 [120/2]
      via fe80::1271:d1ff:fec8:3300, eth-0-12, 00:03:37
```

The following configurations are operated on Switch2:

step 2 Enter the configure mode

```
Switch# configure terminal
```

step 3 Create IPv6 Prefix list

```
Switch(config)# ipv6 prefix-list ripngfilter seq 5 deny 2001:db8:48::/64
Switch(config)# ipv6 prefix-list ripngfilter seq 10 permit any
```

step 4 Apply the IPv6 Prefix list

```
Switch(config)# router ipv6 rip
Switch(config-router)# distribute-list prefix ripngfilter out eth-0-12
Switch(config-router)# exit
```

step 5 Exit the configure mode

```
Switch(config)# end
```

step 6 Validation

Display the result on Switch1:

```
Switch# show ipv6 route rip
R      2001:db8:13::/64 [120/2]
      via fe80::1271:d1ff:fec8:3300, eth-0-12, 00:03:37
```

13.3.3 Application cases

N/A

13.4 Configuring Ipv6 Prefix-list

13.4.1 Overview

Function Introduction

Routing Policy is the technology for modifying route information to change traffic route. IPv6 Prefix list is a kind of route policies that used to control and modify routing information. A IPv6 prefix list is identified by list name and contains one or more ordered entries which are processed sequentially. Each entry provides a matched range for network prefix and has a unique sequence number in the list. In the matching process, switch will check entries orderly. If an entry matches conditions, this process would finish.

Principle Description

N/A

13.4.2 Configuration

Basic Configuration

step 1 Enter the configure mode

```
Switch# configure terminal
```

step 2 Create IPv6 Prefix list

```
Switch(config)# ipv6 prefix-list test seq 1 deny 2001:db8::1/32 le 48
Switch(config)# ipv6 prefix-list test permit any
Switch(config)# ipv6 prefix-list test description this ipv6 prefix list is fot test
Switch(config)# ipv6 prefix-list test permit 2001:abc::1/32 le 48
```

step 3 Exit the configure mode

```
Switch(config)# end
```

step 4 Validation

```
Switch# show ipv6 prefix-list detail
Prefix-list list number: 1
Prefix-list entry number: 3
Prefix-list with the last deletion/insertion: test
ipv6 prefix-list test:
  Description: this ipv6 prefix list is fot test
  count: 3, range entries: 0, sequences: 1 - 10
  seq 1 deny 2001:db8::1/32 le 48 (hit count: 0, refcount: 0)
  seq 5 permit any (hit count: 0, refcount: 0)
  seq 10 permit 2001:abc::1/32 le 48 (hit count: 0, refcount: 0)
```

Used by RIPng

step 1 Enter the configure mode

```
Switch# configure terminal
```

step 2 Create IPv6 Prefix list

```
Switch(config)# ipv6 prefix-list aa seq 11 deny 2001:db8::1/32 le 48
Switch(config)# ipv6 prefix-list aa permit any
```

Step 3 Apply the IPv6 Prefix list

```
Switch(config)# router ipv6 rip
Switch(config-router)# distribute-list prefix aa out
Switch(config-router)# exit
```

step 4 Exit the configure mode

```
Switch(config)# end
```

step 5 Validation

```
Switch# show ipv6 prefix-list
ipv6 prefix-list aa: 2 entries
  seq 11 deny 1:db8::1/32 le 48
  seq 15 permit any

Switch# show running-config
Building configuration...
...
ipv6 prefix-list aa seq 11 deny 1:db8::1/32 le 48
ipv6 prefix-list aa seq 15 permit any
...
router ipv6 rip
distribute-list prefix aa out
```

Used by Route-map

step 1 Enter the configure mode

```
Switch# configure terminal
```

step 2 Create IPv6 Prefix list

```
Switch(config)# ipv6 prefix-list ripng_pre_1 seq 11 permit  
fe80::a8f0:d8ff:fe7d:c501/128  
Switch(config)# ipv6 prefix-list ripng_pre_1 seq 15 permit any
```

step 3 Apply the IPv6 Prefix list to the route map

```
Switch(config)# route-map ripng_rmap permit  
Switch(config-route-map)# match ipv6 address prefix-list ripng_pre_1  
Switch(config-route-map)# set local-preference 200  
Switch(config-route-map)# exit
```

step 4 Apply the route map to the RIPng instance

```
Switch(config)# router ipv6 rip  
Switch(config-router)# redistribute static route-map ripng_rmap  
Switch(config-router)# exit
```

step 5 Exit the configure mode

```
Switch(config)# end
```

step 6 Validation

```
Switch # show route-map  
route-map ripng_rmap, permit, sequence 10  
  Match clauses:  
    ipv6 next-hop prefix-list ripng_pre_1  
  Set clauses:  
    ipv6 next-hop local fe80::1  
  
Switch # show running-config  
Building configuration...  
...  
ipv6 prefix-list ripng_pre_1 seq 11 permit fe80::a8f0:d8ff:fe7d:c501/128  
ipv6 prefix-list ripng_pre_1 seq 15 permit any  
!  
!  
route-map ripng_rmap permit 10  
  match ipv6 next-hop prefix-list ripng_pre_1  
  set ipv6 next-hop local fe80::1  
!
```



```
router ipv6 rip
 redistribute static route-map ripng_rmap
 !
ipv6 route 2001:dbc::/64 fe80::a8f0:d8ff:fe7d:c501 eth-0-9
 !

Switch# show ipv6 rip database
S 2001:dbc::/64          fe80::1          eth-0-9  1  0
```

13.4.3 Application cases

N/A

14 IPv6 Multicast Configuration Guide

14.1 Configuring IPv6 Multicast-Routing

14.1.1 Overview

Function Introduction

Multicast protocols allow a group or channel to be accessed over different networks by multiple stations (clients) for the receipt and transmit of multicast data.

Distribution of stock quotes, video transmissions such as news services and remote classrooms, and video conferencing are all examples of applications that use multicast routing.

- Multicast Listener Discovery (MLD) is used among hosts on a LAN and the routers (and multilayer switches) on that LAN to track the multicast groups of which hosts are members.
- Protocol-Independent Multicast (PIM) protocol is used among routers and multilayer switches to track which multicast packets to forward to each other and to their directly connected LANs. PIM has two modes: Sparse-mode and Dense-mode. Currently, we only support Sparse-mode

Principle Description

N/A

14.1.2 Configuration

Configuring IPv6 multicast route limit

step 1 Enter the configure mode

```
Switch# configure terminal
```

step 2 Set the limit of the IPv6 multicast route

```
Switch(config)# ipv6 multicast route-limit 1000
```

step 3 Exit the configure mode

```
Switch(config)# end
```

step 4 Validation

```
Switch# show ipv6 mroute route-limit
IPv6 Max Multicast Route Limit Number: 1000
IPv6 Multicast Route Limit Warning Threshold: 1000
IPv6 Multicast Hardware Route Limit: 255
IPv6 Current Multicast Route Entry Number: 0
```

14.1.3 Application cases

N/A

14.2 Configuring MLD

14.2.1 Overview

Function Introduction

To participate in IPv6 multicasting, multicast hosts, routers, and multilayer switches must have the MLD operating. This protocol defines the query and host roles:

- A query is a network device that sends query messages to discover which network devices are members of a given multicast group.
- A host is a receiver that sends report messages (in response to query messages) to inform a querier of a host membership.
- A set of queries and hosts that receive IPv6 multicast data streams from the same source is called an IPv6 multicast group. Queries and hosts use MLD messages to join and leave IPv6 multicast groups. Any host, regardless of whether it is a member of a group, can send to a group. However, only the members of a group receive the message. Membership in a multicast group is dynamic; hosts can join and leave at any time. There is no restriction on the location or number of members in a multicast group.

- A host can be a member of more than one multicast group at a time. How active a multicast group is and what members it has can vary from group to group and from time to time. A multicast group can be active for a long time, or it can be very short-lived. Membership in a group can constantly change. A group that has members can have no activity.

MLD packets are sent using these IPv6 multicast group addresses:

- MLD general queries are destined to the address ff02::1 (all systems on a subnet).
- MLD group-specific queries are destined to the group IPv6 address for which the switch is querying.
- MLD group membership reports are destined to the group IPv6 address for which the switch is reporting.
- MLD Version 1 (MLDv1) leave messages are destined to the address ff02::2 (all-multicast-routers on a subnet). In some old host IPv6 stacks, leave messages might be destined to the group IPv6 address rather than to the all-routers address.

Principle Description

The MLD module is based on the following RFC

- RFC 2710
- RFC 3810

14.2.2 Configuration

There is no explicit command to enable MLD, which is always combined with PIMv6-SM. When PIMv6-SM is enabled on an interface, MLD will be enabled automatically on this interface, vice versa. But notice, before MLD can work, IPv6 Multicast-routing must be enabled globally firstly. We support build MLD group record by learning MLD packets or configuring static MLD group by administrator.

step 1 Enter the configure mode

```
Switch# configure terminal
```

step 2 Enable ipv6 and ipv6 multicast-routing globally

```
Switch(config)# ipv6 enable
Switch(config)# ipv6 multicast-routing
```

step 3 Enter the interface configure mode, set the ipv6 address and enable pim sparse mode

```
Switch(config)# interface eth-0-1
Switch(config-if)# no switchport
Switch(config-if)# ipv6 address 2001:1::1/64
Switch(config-if)# ipv6 pim sparse-mode
```

step 4 Configuring MLD Interface Parameters

```
Switch(config-if)# ipv6 mld version 2
Switch(config-if)# ipv6 mld query-interval 120
Switch(config-if)# ipv6 mld query-max-response-time 12
Switch(config-if)# ipv6 mld robustness-variable 3
Switch(config-if)# ipv6 mld last-member-query-count 3
Switch(config-if)# ipv6 mld last-member-query-interval 2000
```

step 5 Limit Max MLD Group Number

Set the maximum of ipv6 mld on the interface:

```
Switch(config-if)# ipv6 mld limit 1000
Switch(config-if)# exit
```

Set the maximum of ipv6 mld globally:

```
Switch(config)# ipv6 mld limit 2000
```

step 6 Create static mld group

```
Switch(config)# interface eth-0-1
Switch(config-if)# ipv6 mld static-group ff0e::1234
Switch(config-if)# exit
```

step 7 Set IPv6 MLD proxy (optional)

```
Switch(config)# interface eth-0-1
Switch(config-if)# no switchport
Switch(config-if)# ipv6 pim sparse-mode
Switch(config-if)# ipv6 mld proxy-service
Switch(config-if)# exit

Switch(config)# interface eth-0-2
Switch(config-if)# no switchport
```

```
Switch(config-if)# ipv6 pim sparse-mode
Switch(config-if)# ipv6 mld mroute-proxy eth-0-1
Switch(config-if)# exit
```

step 8 Exit the configure mode

```
Switch(config)# end
```

step 9 Validation

Displaying MLD Interface:

```
Switch# show ipv6 mld interface
Interface eth-0-2 (Index 2)
  MLD Inactive, Version 1 (default)
  MLD mroute-proxy interface is eth-0-1
  MLD global limit is 2000
  MLD global limit states count is currently 0
  MLD interface limit is 4096
  MLD interface has 0 group-record states
  MLD activity: 0 joins, 0 leaves
  MLD query interval is 125 seconds
  MLD querier timeout is 255 seconds
  MLD max query response time is 10 seconds
  Last member query response interval is 1000 milliseconds
  Group Membership interval is 260 seconds
  Last memeber query count is 2
  Robustness Variable is 2
Interface eth-0-1 (Index 1)
  MLD Inactive, Configured for Version 2 proxy-service
  MLD host version 2
  MLD global limit is 2000
  MLD global limit states count is currently 0
  MLD interface limit is 1000
  MLD interface has 0 group-record states
  MLD activity: 0 joins, 0 leaves
  MLD query interval is 120 seconds
  MLD querier timeout is 366 seconds
  MLD max query response time is 12 seconds
  Last member query response interval is 2000 milliseconds
  Group Membership interval is 372 seconds
  Last memeber query count is 3
  Robustness Variable is 3
```

Displaying MLD group:

```
Switch# show ipv6 mld groups
MLD Connected Group Membership
```

Group Address	Interface	Expires
ff0e::1234	eth-0-1	stopped

14.2.3 Application cases

N/A

14.3 Configuring PIMv6-SM

14.3.1 Overview

Function Introduction

The Protocol Independent Multicasting-Sparse Mode for IPv6 (PIMv6-SM) is a multicast routing protocol designed to operate efficiently across Wide Area Networks (WANs) with sparsely distributed groups. It helps network nodes that are geographically dispersed to conserve bandwidth, and reduces traffic by simultaneously delivering a single stream of information to multiple locations.

PIMv6-SM uses the IPv6 multicast model of receiver-initiated membership, supporting both shared and shortest-path trees, and uses soft-state mechanisms to adapt to changing network conditions. It relies on a topology-gathering protocol to populate a multicast routing table with routes.

Principle Description

The PIMv6-SM module is based on the following IETF standard: RFC 4601

Terminology:

- **Rendezvous Point (RP):** A Rendezvous Point (RP) router is configured as the root of the non-source-specific distribution tree for a multicast group. Join messages from receivers for a group are sent towards the RP. Data from senders is sent to the RP so that receivers can discover who the senders are, and receive traffic destined for the group.
- **Multicast Routing Information Base (MRIB):** The MRIB is a multicast topology table derived from the unicast routing table. In PIMv6-SM, the MRIB is used to decide where to send Join/Prune messages. It also provides routing metrics for destination addresses. These metrics are used when sending and processing Assert messages.

- **Reverse Path Forwarding:** Reverse Path Forwarding (RPF) is a concept of an optimized form of flooding, where the router accepts a packet from SourceA through Interface IF1 only if IF1 is the interface the router would use in order to reach SourceA. It determines whether the interface is correct by consulting its unicast routing tables. The packet that arrives through interface IF1 is forwarded because the routing table lists this interface as the shortest path to the network. The router's unicast routing table determines the shortest path for the multicast packets. Because a router accepts a packet from only one neighbor, it floods the packet only once, meaning that (assuming point-to-point links) each packet is transmitted over each link once in each direction.
- **Tree Information Base (TIB):** The TIB is the collection of state at a PIM router storing the state of all multicast distribution trees at that router. It is created by receiving Join/Prune messages, Assert messages, and MLD information from local hosts.
- **Upstream:** Towards the root of the tree. The root of the tree might be either the Source or the RP.
- **Downstream:** Away from the root of the tree. The root of tree might be either the Source or the RP.
- **Source-Based Trees:** In the Source-Based Trees concept, the forwarding paths are based on the shortest unicast path to the source. If the unicast routing metric is hop counts, the branches of the multicast Source-Based Trees are minimum hop. If the metric is delay, the branches are minimum delay. For every multicast source, there is a corresponding multicast tree that directly connects the source to all receivers. All traffic to the members of an associated group passes along the tree made for their source. Source-Based Trees have two entries with a list of outgoing interfaces-- the source address and the multicast group.
- **Shared Trees:** Shared trees or RP trees (RPT) rely on a central router called the Rendezvous Point (RP) that receives all traffic from the sources, and forwards that traffic to the receivers. All hosts might not be receivers. There is a single tree for each multicast group, regardless of the number of sources. Only the routers on the tree know about the group, and information is sent only to interested receivers. With an RP, receivers have a place to join, even if no source exists. The shared tree is unidirectional, and information flows only from the RP to the receivers. If a host other than the RP has to send data on

the tree, the data must first be tunneled to the RP, and then multicast to the members. This means that even if a receiver is also a source, it can only use the tree to receive packets from the RP, and not to send packets to the RP (unless the source is located between the RP and the receivers).

- **Bootstrap Router (BSR):** When a new multicast sender starts sending data packets, or a new receiver starts sending the Join message towards the RP for that multicast group, it needs to know the next-hop router towards the RP. The BSR provides group-to-RP mapping information to all the PIMv6 routers in a domain, allowing them to map to the correct RP address.
- **Sending out Hello Messages:** PIMv6 routers periodically send Hello messages to discover neighboring PIMv6 routers. Hello messages are multicast using the address ff02::d (ALL-PIMv6-ROUTERS group). Routers do not send any acknowledgement that a Hello message was received. A hold time value determines the length of time for which the information is valid. In PIMv6-SM, a downstream receiver must join a group before traffic is forwarded on the interface.
- **Electing a Designated Router:** In a multi-access network with multiple routers connected, one of them is selected to act as a designated router (DR) for a given period of time. The DR is responsible for sending Join/Prune messages to the RP for local members.
- **Determining the RP:** PIMv6-SM uses a Bootstrap Router (BSR) to originate Bootstrap messages, and to disseminate RP information. The messages are multicast to the group on each link. If the BSR is not apparent, the routers flood the domain with advertisements. The router with the highest priority (if priorities are same, the higher IPv6 address applies) is selected to be the RP. Routers receive and store Bootstrap messages originated by the BSR. When a DR gets a membership indication from MLD for (or a data packet from) a directly connected host, for a group for which it has no entry, the DR maps the group address to one of the candidate RPs that can service that group. The DR then sends a Join/Prune message towards that RP. In a small domain, the RP can also be configured statically.
- **Joining the Shared Tree:** To join a multicast group, a host sends an MLD message to its upstream router, after which the router can accept multicast traffic for that group. The router sends a Join message to its upstream PIMv6 neighbor in the direction of the RP. When a router receives a Join message

from a downstream router, it checks to see if a state exists for the group in its multicast routing table. If a state already exists, the Join message has reached the shared tree, and the interface from which the message was received is entered in the Outgoing Interface list. If no state exists, an entry is created, the interface is entered in the Outgoing Interface list, and the Join message is again sent towards the RP.

- **Registering with the RP:** A DR can begin receiving traffic from a source without having a Source or a Group state for that source. In this case, the DR has no information on how to get multicast traffic to the RP through a tree. When the source DR receives the initial multicast packet, it encapsulates it in a Register message, and unicasts it to the RP for that group. The RP decapsulates each Register message, and forwards the extracted data packet to downstream members on the RPT. Once the path is established from the source to the RP, the DR begins sending traffic to the RP as standard IPv6 multicast packets, as well as encapsulated within Register messages. The RP temporarily receives packets twice. When the RP detects the normal multicast packets, it sends a Register-Stop message to the source DR, meaning it should stop sending register packets.
- **Sending Register-Stop Messages:** When the RP begins receiving traffic from the source, both as Register messages and as unencapsulated IPv6 packets, it sends a Register-Stop message to the DR. This notifies the DR that the traffic is now being received as standard IPv6 multicast packets on the SPT. When the DR receives this message, it stops encapsulating traffic in Register messages.
- **Pruning the Interface:** Routers attached to receivers send Prune messages to the RP to disassociate the source from the RP. When an RP receives a Prune message, it no longer forwards traffic from the source indicated in the Prune message. If all members of a multicast group are pruned, the MLD state of the DR is deleted, and the interface is removed from the Source and Group lists of the group.
- **Forwarding Multicast Packets:** PIMv6-SM routers forward multicast traffic onto all interfaces that lead to receivers that have explicitly joined a multicast group. Messages are sent to a group address in the local subnetwork, and have a Time to Live (TTL) of 1. The router performs an RPF check, and forwards the packet. Traffic that arrives on the correct interface is sent onto all outgoing interfaces that lead to downstream receivers if the downstream router has sent a join to this router, or is a member of this group.

14.3.2 Configuration

Configuring General PIMv6 Sparse-mode (With static RP)

PIMv6-SM is a soft-state protocol. The main requirement is to enable PIMv6-SM on desired interfaces, and configure the RP information correctly, through static or dynamic methods. All multicast group states are maintained dynamically as the result of MLD Report/Leave and PIMv6 Join/Prune messages. Currently, we support only one RP for all multicast groups (ff00::/8).

This section provides PIMv6-SM configuration examples for two relevant scenarios.

In this example, using the above topology, Switch1 is the Rendezvous Point (RP), and all routers are statically configured with RP information. While configuring the RP, make sure that:

- Every router includes the `ipv6 pim rp-address 2001:1::1` statement, even if it does not have any source or group member attached to it.
- There is only one RP address for a group scope in the PIMv6 domain.
- All interfaces running PIMv6-SM must have sparse-mode enabled.

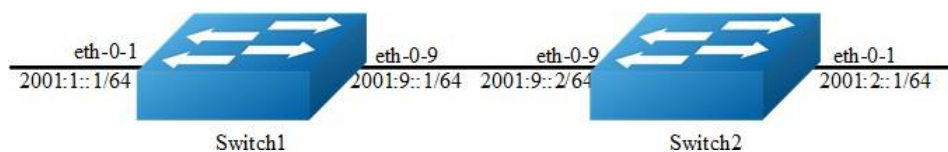

Figure 14-1 PIMv6 Sparse-mode

The graphic above displays the network topology used in these examples:

The following configuration should be operated on all switches if the switch ID is not specified.

step 1 Enter the configure mode

```
Switch# configure terminal
```

step 2 Enable IPv6 & IPv6 multicast globally

```
Switch(config)# ipv6 enable
Switch(config)# ipv6 multicast-routing
```

step 3 Enter the interface configure mode and set the attributes of the interface

Interface configuration for Switch1:

```
Switch(config)# interface eth-0-1
Switch(config-if)# no shutdown
Switch(config-if)# no switchport
Switch(config-if)# ipv6 address 2001:1::1/64
Switch(config-if)# ipv6 pim sparse-mode
Switch(config-if)# exit

Switch(config)# interface eth-0-9
Switch(config-if)# no shutdown
Switch(config-if)# no switchport
Switch(config-if)# ipv6 address 2001:9::1/64
Switch(config-if)# ipv6 pim sparse-mode
Switch(config-if)# exit
```

Interface configuration for Switch2:

```
Switch(config)# interface eth-0-1
Switch(config-if)# no shutdown
Switch(config-if)# no switchport
Switch(config-if)# ipv6 address 2001:2::1/64
Switch(config-if)# ipv6 pim sparse-mode
Switch(config-if)# exit

Switch(config)# interface eth-0-9
Switch(config-if)# no shutdown
Switch(config-if)# no switchport
Switch(config-if)# ipv6 address 2001:9::2/64
Switch(config-if)# ipv6 pim sparse-mode
Switch(config-if)# exit
```

step 4 Create static unicast routes

Configuring Switch1:

```
Switch(config)# ipv6 route 2001:2::/64 2001:9::2
```

Configuring Switch2:

```
Switch(config)# ipv6 route 2001:1::/64 2001:9::1
```

step 5 Configure static RP address

```
Switch(config)# ipv6 pim rp-address 2001:1::1
```

step 6 Exit the configure mode

```
Switch(config)# end
```

step 7 Validation

Configure all the routers with the same ipv6 pim rp-address 2001:1::1 command as shown above. Use the following commands to verify the RP configuration, interface details, and the multicast routing table.

RP Details

At Switch1, the show ip pim sparse-mode rp mapping command shows that 11.1.1.1 is the RP for all multicast groups ff00::/8, and is statically configured. All other routers will have a similar output.

```
Switch# show ipv6 pim sparse-mode rp mapping
PIM Group-to-RP Mappings
Group(s): ff00::/8, Static
  RP: 2001:1::1
      Uptime: 00:00:04
Embedded RP Groups:
```

Interface Details

The show ipv6 pim sparse-mode interface command displays the interface details for Switch1.

```
Switch# show ipv6 pim sparse-mode interface
Interface      VIFindex Ver/  Nbr   DR
              Mode   Count Prior
eth-0-1        2      v2/S   0     1
  Address      : fe80::fc94:efff:fe96:2600
  Global Address: 2001:1::1
  DR           : this system
eth-0-9        0      v2/S   0     1
  Address      : fe80::fc94:efff:fe96:2600
  Global Address: 2001:9::1
  DR           : this system
```

IPv6 Multicast Routing Table

The show ipv6 pim sparse-mode mroute detail command displays the IPv6 multicast routing table.

Display the result on Switch1:

```
Switch# show ipv6 pim sparse-mode mroute detail
IPv6 Multicast Routing Table
(*,*,RP) Entries: 0
(*,G) Entries: 1
(S,G) Entries: 0
(S,G,rpt) Entries: 0
FCR Entries: 0
```

```

*, ff0e::1234:5678
Type: (*,G)
Uptime: 00:01:37
  RP: 2001:1::1, RPF nbr: None, RPF idx: None
  Upstream:
    State: JOINED, SPT Switch: Enabled, JT: off
    Macro state: Join Desired,
  Downstream:
    eth-0-1:
      State: NO INFO, ET: off, PPT: off
      Assert State: NO INFO, AT: off
      Winner: ::, Metric: 4294967295, Pref: 4294967295, RPT bit: on
      Macro state: Could Assert, Assert Track
  Local Olist:
    eth-0-1

```

Display the result on Switch2:

```

Switch# show ipv6 pim sparse-mode mroute detail
IPv6 Multicast Routing Table
(*,*,RP) Entries: 0
(*,G) Entries: 1
(S,G) Entries: 0
(S,G,rpt) Entries: 0
FCR Entries: 0
*, ff0e::1234:5678
Type: (*,G)
Uptime: 00:00:06
  RP: 2001:1::1, RPF nbr: None, RPF idx: None
  Upstream:
    State: JOINED, SPT Switch: Enabled, JT: off
    Macro state: Join Desired,
  Downstream:
    eth-0-1:
      State: NO INFO, ET: off, PPT: off
      Assert State: NO INFO, AT: off
      Winner: ::, Metric: 4294967295, Pref: 4294967295, RPT bit: on
      Macro state: Could Assert, Assert Track
  Local Olist:
    eth-0-1

```

Configuring General PIMv6 Sparse-mode (With dynamic RP)

A static configuration of RP works for a small, stable PIMv6 domain; however, it is not practical for a large and not-suitable internet work. In such a network, if the RP fails, the network administrator might have to change the static configurations on all PIMv6 routers. Another reason for choosing dynamic configuration is a higher routing traffic leading to a change in the RP.

We use the BSR mechanism to dynamically maintain the RP information. For configuring RP dynamically in the above scenario, Switch1 on eth-0-1 and Switch2 on

eth-0-9 are configured as Candidate RP using the `ipv6 pim rp candidate` command. Switch2 on eth-0-9 is also configured as Candidate BSR. Since no other router has been configured as Candidate BSR, the Switch2 becomes the BSR router, and is responsible for sending group-to-RP mapping information to all other routers in this PIMv6 domain.

The following output displays the complete configuration at Switch1 and Switch2.

The following configuration should be operated on all switches if the switch ID is not specified.

step 1 Enter the configure mode

```
Switch# configure terminal
```

step 2 Enable IPv6 & IPv6 multicast globally

```
Switch(config)# ipv6 enable
Switch(config)# ipv6 multicast-routing
```

step 3 Enter the interface configure mode and set the attributes of the interface

Interface configuration for Switch1:

```
Switch(config)# interface eth-0-1
Switch(config-if)# no shutdown
Switch(config-if)# no switchport
Switch(config-if)# ipv6 address 2001:1::1/64
Switch(config-if)# ipv6 pim sparse-mode
Switch(config-if)# exit

Switch(config)# interface eth-0-9
Switch(config-if)# no shutdown
Switch(config-if)# no switchport
Switch(config-if)# ipv6 address 2001:9::1/64
Switch(config-if)# ipv6 pim sparse-mode
Switch(config-if)# exit
```

Interface configuration for Switch2:

```
Switch(config)# interface eth-0-1
Switch(config-if)# no shutdown
Switch(config-if)# no switchport
Switch(config-if)# ipv6 address 2001:2::1/64
Switch(config-if)# ipv6 pim sparse-mode
Switch(config-if)# exit

Switch(config)# interface eth-0-9
Switch(config-if)# no shutdown
```

```
Switch(config-if)# no switchport
Switch(config-if)# ipv6 address 2001:9::2/64
Switch(config-if)# ipv6 pim sparse-mode
Switch(config-if)# exit
```

step 4 Create static unicast routes

Configuring Switch1:

```
Switch(config)# ipv6 route 2001:2::/64 2001:9::2
```

Configuring Switch2:

```
Switch(config)# ipv6 route 2001:1::/64 2001:9::1
```

step 5 Configure the candidate rp

Configuring Switch1:

```
Switch(config)# ipv6 pim rp-candidate eth-0-1
```

Configuring Switch2:

```
Switch(config)# ipv6 pim rp-candidate eth-0-9
```

step 6 Configure the candidate bsr

Configuring Switch2:

```
Switch(config)# ipv6 pim bsr-candidate eth-0-9
```



NOTE The highest priority router is chosen as the RP. If two or more routers have the same priority, a hash function in the BSR mechanism is used to choose the RP, to make sure that all routers in the PIMv6-domain have the same RP for the same group.

step 7 Exit the configure mode

```
Switch(config)# end
```

step 8 Validation

PIMv6 group-to-RP mappings

Use the `show ip pim sparse-mode rp mapping` command to display the group-to-RP mapping details. The output displays information about RP candidates. There are

two RP candidates for the group range ff00::/8. RP Candidate 2001:1::1 has a default priority of 192, whereas, RP Candidate 2001:9::2 has been configured to have a priority of 2. Since RP candidate 2001:1::1 has a higher priority, it is selected as RP for the multicast group ff00::/8. Only permit filters would be cared in group list.。

Display the result on Switch2:

```
Switch# show ipv6 pim sparse-mode rp mapping
PIM Group-to-RP Mappings
This system is the Bootstrap Router (v2)
Group(s): ff00::/8
  RP: 2001:9::2
    Info source: 2001:9::2, via bootstrap, priority 2
    Uptime: 00:00:32, expires: 00:02:02
  RP: 2001:1::1
    Info source: 2001:1::1, via bootstrap, priority 192
    Uptime: 00:00:31, expires: 00:02:03
Embedded RP Groups:
```

RP details

To display information about the RP router for a particular group, use the following command. This output displays that 2001:9::2 has been chosen as the RP for the multicast group ff02::1234.

Display the result on Switch2:

```
Switch# show ipv6 pim sparse-mode rp-hash ff02::1234

Info source: 2001:9::2, via bootstrap
```



NOTE

After RP information reaches all PIMv6 routers in the domain, various state machines maintain all routing states as the result of Join/Prune from group membership. To display information on interface details and the multicast routing table, refer to the Configuring RP Statically section above.

Configuring Bootstrap Router

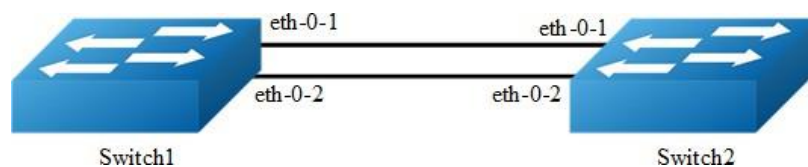

Figure 14-2 BSR

Every PIMv6 multicast group needs to be associated with the IPv6 address of a Rendezvous Point (RP). This address is used as the root of a group-specific distribution tree whose branches extend to all nodes in the domain that want to receive traffic sent to the group. For all senders to reach all receivers, all routers in the domain use the same mappings of group addresses to RP addresses. In order to determine the RP for a multicast group, a PIMv6 router maintains a collection of group-to-RP mappings, called the RP-Set.

The Bootstrap Router (BSR) mechanism for the class of multicast routing protocols in the PIMv6 domain use the concept of a Rendezvous Point as a means for receivers to discover the sources that send to a particular multicast group. The BSR mechanism is one way that a multicast router can learn the set of group-to-RP mappings required in order to function.

Some of the PIMv6 routers within a PIMv6 domain are configured as Candidate-RPs (C-RPs). A subset of the C-RPs will eventually be used as the actual RPs for the domain. An RP configured with a lower value in the priority field has higher a priority.

Some of the PIMv6 routers in the domain are configured to be Candidate-BSRs (C-BSRs). One of these C-BSRs is elected to be the bootstrap router (BSR) for the domain, and all PIMv6 routers in the domain learn the result of this election through BSM (Bootstrap messages). The C-BSR with highest value in priority field is Elected-BSR.

The C-RPs then reports their candidacy to the elected BSR, which chooses a subset of the C-RPs and distributes corresponding group-to-RP mappings to all the routers in the domain through Bootstrap messages.

The following configuration should be operated on all switches if the switch ID is not specified.

step 1 Enter the configure mode

```
Switch# configure terminal
```

step 2 Enable IPv6 & IPv6 multicast globally

```
Switch(config)# ipv6 enable  
Switch(config)# ipv6 multicast-routing
```

step 3 Configure the candidate bsr

Configuring Switch1:

```
Switch(config)# ipv6 pim bsr-candidate eth-0-1
```

Configuring Switch2:

```
Switch(config)# ipv6 pim bsr-candidate eth-0-1 10 25
```

step 4 Configure the candidate rp

Configuring Switch2:

```
Switch(config)# ipv6 pim rp-candidate eth-0-1 priority 0
```

step 5 Enter the interface configure mode and set the attributes of the interface

Interface configuration for Switch2:

```
Switch(config)# interface eth-0-1
Switch(config-if)# ipv6 pim dr-priority 10
Switch(config-if)# ipv6 pim unicast-bsm
Switch(config-if)# exit
```

step 5 Exit the configure mode

```
Switch(config)# end
```

step 6 Validation

Verify the C-BSR state on rtr1

```
Switch# show ipv6 pim sparse-mode bsr-router
PIM6v2 Bootstrap information
This system is the Bootstrap Router (BSR)
  BSR address: 2001:9::1 (?)
  Uptime:      00:01:27, BSR Priority: 64, Hash mask length: 126
  Next bootstrap message in 00:00:16
  Role: Candidate BSR
  State: Elected BSR
```

Verify the C-BSR state on rtr2. The initial state of C-BSR is P-BSR before transitioning to C-BSR.

```
Switch# show ipv6 pim sparse-mode bsr-router
PIM6v2 Bootstrap information
  BSR address: 2001:9::1 (?)
  Uptime:      00:01:34, BSR Priority: 64, Hash mask length: 126
  Expires:     00:01:51
  Role: Candidate BSR
  State: Candidate BSR
  Candidate RP: 2001:9::2(eth-0-9)
    Advertisement interval 60 seconds
    Next C-RP advertisement in 00:00:35
```

Verify RP-set information on E-BSR

```
Switch# show ipv6 pim sparse-mode rp mapping
PIM Group-to-RP Mappings
This system is the Bootstrap Router (v2)
Group(s): ff00::/8
  RP: 2001:9::2
    Info source: 2001:9::2, via bootstrap, priority 0
    Uptime: 00:45:37, expires: 00:02:29
Embedded RP Groups:
```

Verify RP-set information on C-BSR

```
Switch# show ipv6 pim sparse-mode rp mapping
PIM Group-to-RP Mappings
Group(s): ff00::/8
  RP: 2001:9::2
    Info source: 2001:9::1, via bootstrap, priority 0
    Uptime: 00:03:14, expires: 00:01:51
Embedded RP Groups:
```

Configuring PIMv6-SSM feature

PIMv6-SSM can work with PIMv6-SM on the multicast router. By default, PIMv6-SSM is disabled.

step 1 Enter the configure mode

```
Switch# configure terminal
```

step 2 Enable PIMv6-ssm globally

```
Switch(config)# ipv6 pim ssm default
Switch(config)# ipv6 pim ssm range ipv6acl
```

step 3 Exit the configure mode

```
Switch(config)# end
```

14.3.3 Application cases

N/A

14.4 Configuring PIMv6-DM

14.4.1 Overview

Function Introduction

The Ipv6 Protocol Independent Multicasting-Dense Mode (PIMv6-DM) is a multicast routing protocol designed to operate efficiently across Wide Area Networks (WANs) with densely distributed groups. It helps network nodes that are geographically dispersed to conserve bandwidth, and reduces traffic by simultaneously delivering a single stream of information to multiple locations.

PIMv6-DM assumes that when a source starts sending, all downstream systems want to receive multicast datagrams. Initially, multicast datagrams are flooded to all areas of the network. PIMv6-DM uses RPF to prevent looping of multicast datagrams while flooding. If some areas of the network do not have group members, PIMv6-DM will prune off the forwarding branch by instantiating prune state.

Prune state has a finite lifetime. When that lifetime expires, data will again be forwarded down the previously pruned branch. Prune state is associated with an (S,G) pair. When a new member for a group G appears in a pruned area, a router can "graft" toward the source S for the group, thereby turning the pruned branch back into a forwarding branch.

Principle Description

The PIMv6-DM module is based on the following IETF standard: RFC 3973

14.4.2 Configuration

Configuring General PIM dense-mode

PIMv6-DM is a soft-state protocol. The main requirement is to enable PIMv6-DM on desired interfaces. All multicast group states are maintained dynamically as the result of MLD Report/Leave and PIMv6 messages.

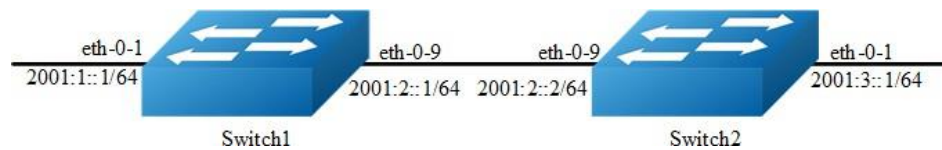

Figure 14-3 PIMv6 dense-mode

This section provides PIMv6-DM configuration examples for two relevant scenarios. The following graphic displays the network topology used in these examples: In this example, using the above topology, multicast data stream comes to eth-0-1 of Switch1, host is connected to eth-0-1 of Switch2. Here is a sample configuration:

The following configuration should be operated on all switches if the switch ID is not specified.

step 1 Enter the configure mode

```
Switch# configure terminal
```

step 2 Enable IPv6 & IPv6 multicast globally

```
Switch(config)# ipv6 enable
Switch(config)# ipv6 multicast-routing
```

step 3 Enter the interface configure mode and set the attributes of the interface

Interface configuration for Switch1:

```
Switch(config)# interface eth-0-1
Switch(config-if)# no shutdown
Switch(config-if)# no switchport
Switch(config-if)# ipv6 address 2001:1::1/64
Switch(config-if)# ipv6 pim dense-mode
Switch(config-if)# exit

Switch(config)# interface eth-0-9
Switch(config-if)# no shutdown
Switch(config-if)# no switchport
Switch(config-if)# ipv6 address 2001:2::1/64
Switch(config-if)# ipv6 pim dense-mode
Switch(config-if)# exit
```

Interface configuration for Switch2:

```
Switch(config)# interface eth-0-1
Switch(config-if)# no shutdown
Switch(config-if)# no switchport
Switch(config-if)# ipv6 address 2001:3::1/64
```

```
Switch(config-if)# ipv6 pim dense-mode
Switch(config-if)# exit

Switch(config)# interface eth-0-9
Switch(config-if)# no shutdown
Switch(config-if)# no switchport
Switch(config-if)# ipv6 address 2001:2::2/64
Switch(config-if)# ipv6 pim dense-mode
Switch(config-if)# exit
```

step 4 Create static unicast routes

Configuring Switch1:

```
Switch(config)# ipv6 route 2001:3::/64 2001:2::2
```

Configuring Switch2:

```
Switch(config)# ipv6 route 2001:1::/64 2001:2::1
```

step 5 Exit the configure mode

```
Switch(config)# end
```

step 6 Validation

Interface Details

The show ipv6 pim dense-mode interface command displays the interface details for Switch1.

```
Switch# show ipv6 pim dense-mode interface
```

Neighbor Address	Interface	VIFIndex	Ver/ Mode	Nbr Count
fe80::326f:c9ff:fef2:8200	eth-0-1	0	v2/D	0
fe80::326f:c9ff:fef2:8200	eth-0-9	2	v2/D	1

Neighbor Details

用 show ipv6 pim dense-mode neighbor 来显示 Switch1 上邻居的详细信息

```
Switch# show ipv6 pim sparse-mode neighbor
```

Neighbor Address	Interface	Uptime/Expires	Ver
fe80::ce47:6eff:feb7:1400	eth-0-9	00:51:51/00:01:24	v2

IP Multicast Routing Table

The show ip pim dense-mode mroute detail command displays the IP multicast routing table.

Display the result on Switch1:

```
Switch# show ipv6 pim dense-mode mroute
PIM-DM Multicast Routing Table
(2001:1::2, ff0e::1)
  Source directly connected on eth-0-1
  State-Refresh Originator State: Originator
  Upstream IF: eth-0-1
    Upstream State: Forwarding
    Assert State: NoInfo
  Downstream IF List:
    eth-0-9, in 'olist':
      Downstream State: NoInfo
      Assert State: NoInfo
```

Display the result on Switch2:

```
Switch# show ipv6 pim dense-mode mroute
PIM-DM Multicast Routing Table
(2001:1::2, ff0e::1)
  RPF Neighbor: none
  Upstream IF: eth-0-9
    Upstream State: AckPending
    Assert State: Loser
  Downstream IF List:
    eth-0-1, in 'olist':
      Downstream State: NoInfo
      Assert State: NoInfo
```

14.4.3 Application cases

N/A

14.5 Configuring MLD Snooping

14.5.1 Overview

Function Introduction

Layer 2 switches can use MLD snooping to constrain the flooding of multicast traffic by dynamically configuring Layer 2 interfaces so that multicast traffic is forwarded only to those interfaces associated with IPv6 multicast devices. As the name implies, MLD snooping requires the LAN switch to snoop on the MLD transmissions between the host and the router and to keep track of multicast groups and member ports. When the switch receives an MLD report from a host for a particular multicast group, the switch adds the host port number to the forwarding table entry; when it receives an MLD Leave Group message from a host, it removes the host port from the table

entry. It also deletes entries per entry if it does not receive MLD membership reports from the multicast clients. The multicast router sends out periodic general queries to all VLANs. All hosts interested in this multicast traffic send report and are added to the forwarding table entry. The switch forwards only one report per IPv6 multicast group to the multicast router. It creates one entry per VLAN in the Layer 2 forwarding table for each MAC group from which it receives an MLD report.

Layer 2 multicast groups learned through MLD snooping are dynamic. If you specify group membership for a multicast group address statically, your setting supersedes any automatic manipulation by MLD snooping. Multicast group membership lists can consist of both user-defined and MLD snooping-learned settings.

**NOTE**

Limitations And Configuration Guideline

VRRP, RIPng and OSPFv3 used multicast IPv6 address, so you need to avoid use such multicast IPv6 addresses, which have same multicast MAC address with multicast IPv6 address reserved by VRRP, RIPng and OSPFv3.

- VRRP used multicast group address ff02::12, so when mld snooping and VRRP are working, you need to avoid using multicast group address that matched same mac address with group address ff02::12.
- OSPFv3 used multicast group address ff02::5, so when mld snooping and OSPFv3 are working, you need to avoid using multicast group address that matched same mac address with group address ff02::5.
- RIPng used multicast group address ff02::9, so when mld snooping and RIPng are working, you need to avoid using multicast group address that matched same mac address with group address ff02::9.

Principle Description

N/A

14.5.2 Configuration

Enable MLD Snooping

step 1 Enter the configure mode

```
Switch# configure terminal
```

step 2 Enable mld snooping globally

```
Switch(config)# ipv6 mld snooping
```

step 3 vlan 使能 mld snooping

```
Switch(config)#ipv6 mld snooping vlan 1
```

step 4 Exit the configure mode

```
Switch(config)# end
```

step 5 Validation

```
Switch # show ipv6 mld snooping vlan 1
Global Mld Snooping Configuration
-----
Mld Snooping                               :Enabled
Mld Snooping Fast-Leave                     :Disabled
Mld Snooping Version                       1
Mld Snooping Max-Member-Number            4096
Mld Snooping Unknown Multicast Behavior   :Flood
Mld Snooping Report-Suppression           :Enabled
Vlan 1
-----
Mld Snooping                               :Enabled
Mld Snooping Fast-Leave                     :Disabled
Mld Snooping Report-Suppression           :Enabled
Mld Snooping Version                       1
Mld Snooping Max-Member-Number            4096
Mld Snooping Unknown Multicast Behavior   :Flood
Mld Snooping Group Access-list             :N/A
Mld Snooping Mrouter Port                  :
Mld Snooping Mrouter Port Aging Interval(sec) 255
```

Configuring Fast Leave

When MLD Snooping fast leave is enabled, the mld snooping group will be removed at once upon receiving a corresponding mld report. Otherwise the switch will send out specified mld specific query, if it doesn't get response in specified period, it will remove the group. By default, mld snooping fast-leave is disabled globally and per vlan.

step 1 Enter the configure mode

```
Switch# configure terminal
```

step 2 Enable fast leave globally

```
Switch(config)# ipv6 mld snooping fast-leave
```

step 3 Enable fast leave for a vlan

```
Switch(config)# ipv6 mld snooping vlan 1 fast-leave
```

step 4 Exit the configure mode

```
Switch(config)# end
```

step 5 Validation

```
Switch# show ipv6 mld snooping vlan 1
Global Mld Snooping Configuration
-----
Mld Snooping                               :Enabled
Mld Snooping Fast-Leave                     :Enabled
Mld Snooping Version                       1
Mld Snooping Max-Member-Number            4096
Mld Snooping Unknown Multicast Behavior   :Flood
Mld Snooping Report-Suppression           :Enabled
Vlan 1
-----
Mld Snooping                               :Enabled
Mld Snooping Fast-Leave                     :Enabled
Mld Snooping Report-Suppression           :Enabled
Mld Snooping Version                       1
Mld Snooping Max-Member-Number            4096
Mld Snooping Unknown Multicast Behavior   :Flood
Mld Snooping Group Access-list            :N/A
Mld Snooping Mrouter Port                 :
Mld Snooping Mrouter Port Aging Interval(sec) 255
```

Configuring Querier Parameters (optional)

In order for MLD, and thus MLD snooping, to function, a multicast router must exist on the network and generate MLD queries. The tables created for snooping (holding the member ports for each multicast group) are associated with the querier. Without a querier the tables are not created and snooping will not work.

step 1 Enter the configure mode

```
Switch# configure terminal
```

step 2 Configuring Querier Parameters for MLD snooping

Set mld snooping query interval and max query response time:

```
Switch(config)# ipv6 mld snooping query-interval 100
Switch(config)# ipv6 mld snooping query-max-response-time 5
```

Set mld snooping last member query interval:

```
Switch(config)# ipv6 mld snooping last-member-query-interval 2000
```

Set mld snooping query parameters for vlan 1:

```
Switch(config)# ipv6 mld snooping vlan 1 querier address fe80::1
Switch(config)# ipv6 mld snooping vlan 1 querier
Switch(config)# ipv6 mld snooping vlan 1 query-interval 200
Switch(config)# ipv6 mld snooping vlan 1 query-max-response-time 5
Switch(config)# ipv6 mld snooping vlan 1 querier-timeout 100
Switch(config)# ipv6 mld snooping vlan 1 last-member-query-interval 2000
Switch(config)# ipv6 mld snooping vlan 1 discard-unknown
```

Discard unknown multicast packets globally:

```
Switch(config)# ipv6 mld snooping discard-unknown
```

step 3 Exit the configure mode

```
Switch(config)# end
```

step 4 Validation

```
Switch # show ipv6 mld snooping querier
Global Mld Snooping Querier Configuration
-----
Version                               :1
Last-Member-Query-Interval (msec)    :2000
Max-Query-Response-Time (sec)       5
Query-Interval (sec)                 100
```

```

Global Source-Address      :::
TCN Query Count           2
TCN Query Interval (sec)  10
Vlan 1:  MLD snooping querier status
-----
Elected querier is : fe80::1
-----
Admin state                :Enabled
Admin version              1
Operational state         :Querier
Querier operational address :fe80::1
Querier configure address  :fe80::1
Last-Member-Query-Interval (msec) :2000
Max-Query-Response-Time (sec)  5
Query-Interval (sec)       200
Querier-Timeout (sec)     100

```

Configuring Mrouter Port

An MLD Snooping mrouter port is a switch port which is assumed to connect a multicast router. The mrouter port is configured on the vlan or learnt dynamically. When MLD general query packet or PIMv6 hello packet is received on port of specified VLAN, this port becomes mrouter port of this vlan. All the mld queries received on this port will be flooded on the belonged vlan. All the mld reports and leaves received on this vlan will be forwarded to the mrouter port, directly or aggregated, depending on the report-suppression configuration. In addition, all the multicast traffic on this vlan will be forwarded to this mrouter port.

step 1 Enter the configure mode

```
Switch# configure terminal
```

step 2 Enable mld snooping report suppression globally

```
Switch(config)# ipv6 mld snooping report-suppression
```

step 3 Configure mrouter port

```
Switch(config)# ipv6 mld snooping vlan 1 mrouter interface eth-0-1
```

step 4 Configure mld snooping for parameters vlan

Enable mld snooping report suppression and Set mld snooping dynamic mrouter port aging interval:

```
Switch(config)# ipv6 mld snooping vlan 1 report-suppression
Switch(config)# ipv6 mld snooping vlan 1 mrouter-aging-interval 200
```

step 5 Exit the configure mode

```
Switch(config)# end
```

step 6 Validation

```
Switch# show ipv6 mld snooping vlan 1
Global Mld Snooping Configuration
-----
Mld Snooping                               :Enabled
Mld Snooping Fast-Leave                     :Enabled
Mld Snooping Version                       :1
Mld Snooping Max-Member-Number            :4096
Mld Snooping Unknown Multicast Behavior   :Discard
Mld Snooping Report-Suppression           :Enabled
Vlan 1
-----
Mld Snooping                               :Enabled
Mld Snooping Fast-Leave                     :Enabled
Mld Snooping Report-Suppression           :Enabled
Mld Snooping Version                       1
Mld Snooping Max-Member-Number            4096
Mld Snooping Unknown Multicast Behavior   :Discard
Mld Snooping Group Access-list             :N/A
Mld Snooping Mrouter Port                  :eth-0-1 (static)
Mld Snooping Mrouter Port Aging Interval(sec) 200
```

Configuring Querier Tcn

User can set the TCN interval and query count to adapt the multicast learning and updating after STP converging.

step 1 Enter the configure mode

```
Switch# configure terminal
```

step 2 Set the parameters for MLD Snooping querier TCN

Set mld snooping querier tcn query count and interval:

```
Switch(config)# ipv6 mld snooping querier tcn query-count 5
Switch(config)# ipv6 mld snooping querier tcn query-interval 20
```

step 3 Exit the configure mode

```
Switch(config)# end
```

step 4 Validation

```
Switch # show ipv6 mld snooping querier
Global Mld Snooping Querier Configuration
-----
Version                               1
Last-Member-Query-Interval (msec) :2000
Max-Query-Response-Time (sec)       5
Query-Interval (sec)                100
Global Source-Address                :::
TCN Query Count                      5
TCN Query Interval (sec)             20
Vlan 1:  MLD snooping querier status
-----
Elected querier is : fe80::1
-----
Admin state                           :Enabled
Admin version                          1
Operational state                      :Querier
Querier operational address            :fe80::1
Querier configure address              :fe80::1
Last-Member-Query-Interval (msec) :2000
Max-Query-Response-Time (sec)        5
Query-Interval (sec)                  200
Querier-Timeout (sec)                 100
```

Configuring Report Suppression

The switch uses MLD report suppression to forward only one MLD report per multicast router query to multicast devices. When MLD router suppression is enabled (the default), the switch sends the first MLD report from all hosts for a group to all the multicast routers. The switch does not send the remaining MLD reports for the group to the multicast routers. This feature prevents duplicate reports from being sent to the multicast devices.

step 1 Enter the configure mode

```
Switch# configure terminal
```

step 2 Enable mld snooping report suppression globally

```
Switch(config)# ipv6 mld snooping report-suppression
```

step 3 Enable mld snooping report suppression for a vlan

```
Switch(config)# ipv6 mld snooping vlan 1 report-suppression
```

step 4 Exit the configure mode

```
Switch(config)# end
```

step 5 Validation

```
Switch # show ipv6 mld snooping
Global Mld Snooping Configuration
-----
Mld Snooping :Enabled
Mld Snooping Fast-Leave :Disabled
Mld Snooping Version 2
Mld Snooping Max-Member-Number 4096
Mld Snooping Unknown Multicast Behavior :Flood
Mld Snooping Report-Suppression :Enabled
Vlan 1
Mld Snooping :Enabled
Mld Snooping Fast-Leave :Disabled
Mld Snooping Report-Suppression :Enabled
Mld Snooping Version 2
Mld Snooping Max-Member-Number 4096
Mld Snooping Unknown Multicast Behavior :Flood
Mld Snooping Group Access-list :N/A
Mld Snooping Mrouter Port :
Mld Snooping Mrouter Port Aging Interval(sec) 255
```

Configuring Static group

The switch can build MLD Snooping Group when receiving MLD report packet on Layer 2 port of specified VLAN. We also support configure static MLD Snooping Group by specifying MLD group, Layer 2 port and VLAN.

step 1 Enter the configure mode

```
Switch# configure terminal
```

step 2 Configure static group

```
Switch(config)# ipv6 mld snooping vlan 1 static-group ff0e::1234 interface eth-0-2
```

step 3 Exit the configure mode

```
Switch(config)# end
```

step 4 Validation

```
Switch# show ipv6 mld snooping groups
VLAN  Interface  Group Address      Uptime      Expire-time
1     eth-0-2      ff0e::1234        00:00:02    stopped
```

14.5.3 Application cases

N/A

14.6 Configuring MVR6

14.6.1 Overview

Function Introduction

Multicast VLAN Registration for IPv6 (MVR6) is designed for applications using wide-scale deployment of IPv6 multicast traffic across an Ethernet ring-based service provider network (for example, the broadcast of IPv6 multiple television channels over a service-provider network). MVR6 allows a subscriber on a port to subscribe and unsubscribe to an IPv6 multicast stream on the network-wide multicast VLAN. It allows the single multicast VLAN to be shared in the network while subscribers remain in separate VLANs. MVR6 provides the ability to continuously send IPv6 multicast streams in the multicast VLAN, but to isolate the streams from the subscriber VLANs for bandwidth and security reasons.

MVR6 assumes that subscriber ports subscribe and unsubscribe (join and leave) these multicast streams by sending out MLD join and leave messages. These messages can originate from an MLD version-1-compatible host with an Ethernet connection. Although MVR6 operates on the underlying mechanism of MLD snooping, the two features operation affect with each other. One can be enabled or disabled with affecting the behavior of the other feature. If MLD snooping and MVR6 are both enabled, MVR6 reacts only to join and leave messages from IPv6 multicast groups configured under MVR6. The switch CPU identifies the MVR6 IPv6 multicast streams and their associated MAC addresses in the switch forwarding table, intercepts the MLD messages, and modifies the forwarding table to include or remove the subscriber as a receiver of the multicast stream, and the receivers must be in a different VLAN

from the source. This forwarding behavior selectively allows traffic to cross between different VLANs.

Principle Description

N/A

14.6.2 Configuration

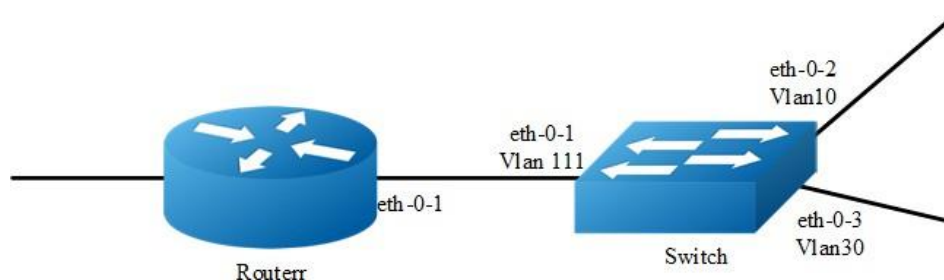

Figure 14-4 MVR6

step 1 Enter the configure mode

Configuring Switch:

```
Switch# configure terminal
```

Configuring Router:

```
Router# configure terminal
```

step 2 Enter the vlan configure mode and create VLANs

Configuring Switch:

```
Switch(config)# vlan database
Switch(config-vlan)# vlan 111,10,30
Switch(config-vlan)# quit
```

step 3 Enter the interface configure mode and set the attributes of the interface

Interface configuration for Router:

```
Router(config)# interface eth-0-1
Router(config-if)# no switchport
Router(config-if)# no shutdown
Router(config-if)# ipv6 address 2001:1::1/64
```

```
Router(config-if)# ipv6 pim sparse-mode
Router(config-if)# end
```

Interface configuration for Switch:

```
Switch(config)# interface vlan 111
Switch(config-if)# exit

Switch(config)# interface vlan 10
Switch(config-if)# exit

Switch(config)# interface vlan 30
Switch(config-if)# exit

Switch(config)# interface eth-0-1
Switch(config-if)# switchport access vlan111
Switch(config-if)# exit

Switch(config)# interface eth-0-2
Switch(config-if)# switchport access vlan10
Switch(config-if)# exit

Switch(config)# interface eth-0-3
Switch(config-if)# switchport access vlan30
Switch(config-if)# exit
```

step 4 Enable MVR6

Enable MVR6 in the switch, it is required that only one copy of IPv6 multicast traffic from the Router is sent to the switch, but the hosts can both receiver this IPv6 multicast traffic.

```
Switch(config)# no ipv6 multicast-routing
Switch(config)# mvr6
Switch(config)# mvr6 vlan 111
Switch(config)# mvr6 group ff0e::1234 64
Switch(config)# mvr6 source-address fe80::1111

Switch(config)# interface eth-0-1
Switch(config-if)# mvr6 type source
Switch(config-if)# exit

Switch(config)# interface eth-0-2
Switch(config-if)# mvr6 type receiver vlan 10
Switch(config-if)# exit

Switch(config)# interface eth-0-3
Switch(config-if)# mvr6 type receiver vlan 30
Switch(config-if)# exit
```

step 5 Exit the configure mode

```
Switch(config)# end
```

step 6 Validation

Display the result on Router:

```
Router# show ipv6 mld groups
MLD Connected Group Membership
Group Address                               Interface    Expires
ff0e::1234                                  eth-0-2     00:03:01
ff0e::1235                                  eth-0-2     00:03:01
ff0e::1236                                  eth-0-2     00:03:01
ff0e::1237                                  eth-0-2     00:03:01
ff0e::1238                                  eth-0-2     00:03:01
.....
ff0e::1273                                  eth-0-2     00:03:01
```

Display the result on Switch:

```
Switch# show mvr6
MVR6 Running: TRUE
MVR6 Multicast VLAN: 111
MVR6 Source-address: fe80::111
MVR6 Max Multicast Groups: 1024
MVR6 Hw Rt Limit: 224
MVR6 Current Multicast Groups: 64

VLAN  Interface  Group Address          Uptime      Expire-time
10    eth-0-2    ff0e::1234            00:03:23   00:02:03
10    eth-0-2    ff0e::1235            00:03:23   00:02:03
10    eth-0-2    ff0e::1236            00:03:23   00:02:03
10    eth-0-2    ff0e::1237            00:03:23   00:02:03
10    eth-0-2    ff0e::1238            00:03:23   00:02:03
10    eth-0-2    ff0e::1239            00:03:23   00:02:03
.....
10    eth-0-2    ff0e::1273            00:03:23   00:02:03
```

14.6.3 Application cases

N/A

15 VPN Configuration Guide

15.1 Configuring VPN

15.1.1 Overview

Function Introduction

VPN is defined as a collection of sites sharing a common routing table. A customer site is connected to the service provider network by one or more interfaces, where the service provider associates each interface with a VPN routing table. A VPN routing table is called a VPN routing and forwarding (VRF) table. Beginning in privileged EXEC mode, follow these steps to configure one or more VRFs.

Principle Description

N/A

15.1.2 Configuration

step 1 Enter the configure mode

```
Switch# configure terminal
```

step 2 Create a vrf instance

```
Switch(config)# ip vrf vpn1  
Switch(config-vrf)# rd 100:1  
Switch(config-vrf)# router-id 1.1.1.1  
Switch(config-vrf)# route-target both 100:1  
Switch(config-vrf)# import map route-map
```



NOTE

Enter either an AS system number

step 3 Enter the interface configure mode and set the attributes of the interface

```
Switch(config-vrf)# interface eth-0-1
Switch(config-if)# no shutdown
Switch(config-if)# no switch
Switch(config-if)# ip vrf forwarding vpn1
Switch(config-if)# ip add 1.1.1.1/24
Switch(config-if)# end
```

step 4 Exit the configure mode

```
Switch(config)# end
```

step 5 Validation

The result of show information about the configured VRFs:

```
Switch# show ip vrf
VRF vpn1, FIB ID 1
Router ID: 1.1.1.1 (config)
Interfaces:
  eth-0-1

Switch# show ip vrf interfaces vpn1
Interface          IP-Address      VRF          Protocol
eth-0-1            1.1.1.1        vpn1         up

Switch# show ip vrf bgp brief
Name              Default RD      Interfaces
vpn1              100:1          eth-0-1

Switch# show ip vrf bgp detail
VRF vpn1; default RD 100:1
Interfaces:
  eth-0-1
VRF Table ID = 1
Export VPN route-target communities
  RT:100:1
Import VPN route-target communities
  RT:100:1
import-map: route-map
No export route-map
```

15.1.3 Application cases

N/A

15.2 Configuring IPv4 GRE Tunnel

15.2.1 Overview

Function Introduction

Tunneling is an encapsulation technology, which uses one network protocol to encapsulate packet of another network protocol and transfer them over a virtual point to point connection. The virtual connection is called a tunnel. Tunneling refers to the whole process from data encapsulation to data transfer to data de-encapsulation.

Principle Description

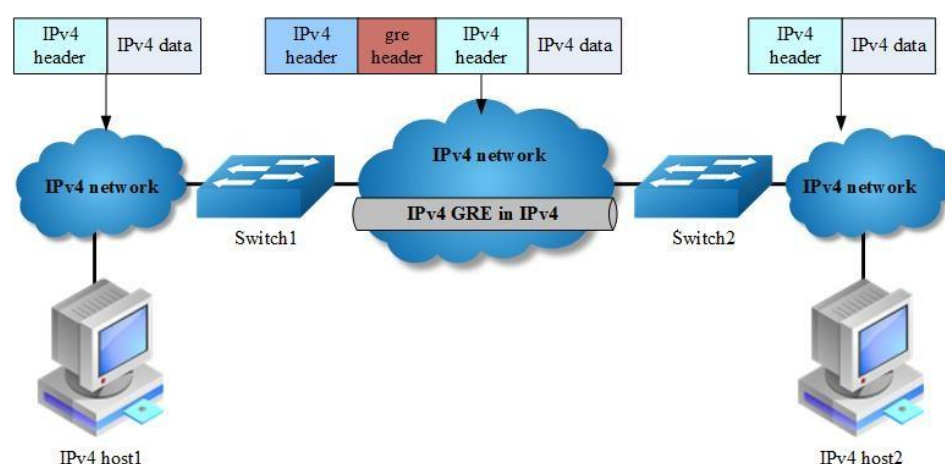

Figure 15-1 IPv4 gre over IPv4

When it is required to communicate with isolated IPv4 networks, you should create a tunnel mechanism between them. The tunnel with transmit protocol of gre connected with two isolated IPv4 island is called IPv4 gre tunnel, which is that IPv4 packets are encapsulated by gre protocol over outer IPv4 packets. Gre tunnel would add gre head in encapsulated packets, including key, sequence, checksum and so on. In order to make an implement of gre tunnel, both tunnel endpoints must support the IPv4 protocol stacks.

IPv4 gre tunnel processes packets in the following ways:

- A host in the IPv4 network sends an IPv4 packet to Switch1 at the tunnel source.

- After determining according to the routing table that the packet needs to be forwarded through the tunnel, Switch1 encapsulates the IPv4 packet with an IPv4 header and forwards it through the physical interface of the tunnel.
- Upon receiving the packet, Switch2 de-encapsulates the packet.
- Switch2 forwards the packet according to the destination address in the de-encapsulated IPv4 packet. If the destination address is the device itself, Switch2 forwards the IPv4 packet to the upper-layer protocol for processing. In the process of de-encapsulation, it would check gre key, only the matched key of packet can be processed, otherwise discarded.

The ip address of tunnel source and tunnel destination is manually assigned, and it provides point-to-point connection. By using overlay tunnels, you can communicate with isolated IPv4 networks without upgrading the IPv4 infrastructure between them. Overlay tunnels can be configured between border routers or between border routers and a host.

The primary use is for stable connections that require regular secure communication between two edge routers or between an end system and an edge router, or for connection to remote IPv4 networks, gre key is alternative configuration.

15.2.2 Configuration

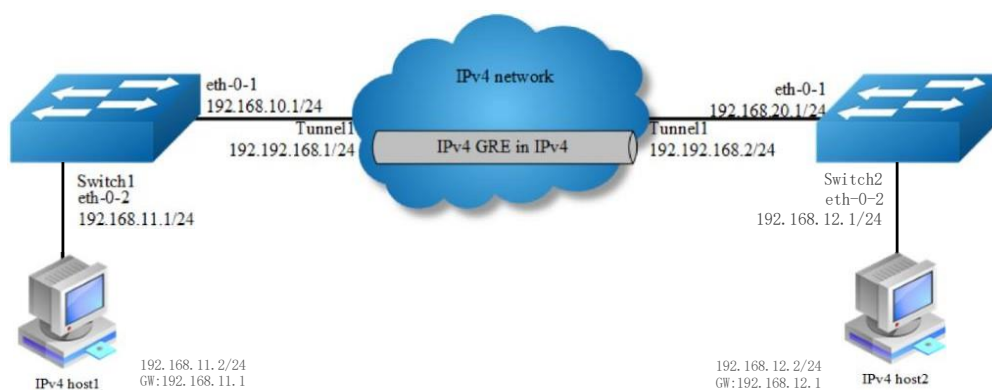

Figure 15-2 IPv4 gre Tunnel

As the topology shows, two IPv4 networks connect to the network via Switch1 and Switch2. An Ipv4 gre tunnel is required between Switch1 and Switch2, in order to connect two networks.



NOTE A reachable Ipv4 route is necessary for forwarding tunnel packet. Ipv4 address must be configured on tunnel interface; otherwise the route via this tunnel interface is invalid.

The following configuration should be operated on all switches if the switch ID is not specified.

step 1 Enter the configure mode

```
Switch# configure terminal
```

step 2 Enter the interface configure mode and set the attributes of the interface

Interface configuration for Switch1:

```
Switch(config)# interface eth-0-1
Switch(config-if)# no switchport
Switch(config-if)# no shutdown
Switch(config-if)# ip address 192.168.10.1/24
Switch(config-if)# tunnel enable
Switch(config-if)# exit

Switch(config)# interface eth-0-2
Switch(config-if)# no switchport
Switch(config-if)# no shutdown
Switch(config-if)# ip address 192.168.11.1/24
Switch(config-if)# exit
```

Interface configuration for Switch2:

```
Switch(config)# interface eth-0-1
Switch(config-if)# no switchport
Switch(config-if)# no shutdown
Switch(config-if)# ip address 192.168.20.1/24
Switch(config-if)# tunnel enable
Switch(config-if)# exit

Switch(config)# interface eth-0-2
Switch(config-if)# no switchport
Switch(config-if)# no shutdown
Switch(config-if)# ip address 192.168.12.1/24
Switch(config-if)# exit
```

step 3 Configure the tunnel interface

Tunnel interface configuration for Switch1:

```
Switch(config)# interface tunnel1
Switch(config-if)# tunnel mode gre
```

```
Switch(config-if)# tunnel source eth-0-1
Switch(config-if)# tunnel destination 192.168.20.1
Switch(config-if)# tunnel gre key 100
Switch(config-if)# ip address 192.192.168.1/24
Switch(config-if)# keepalive 5 3
Switch(config-if)# exit
```

Tunnel interface configuration for Switch2:

```
Switch(config)# interface tunnell
Switch(config-if)# tunnel mode gre
Switch(config-if)# tunnel source eth-0-1
Switch(config-if)# tunnel destination 192.168.10.1
Switch(config-if)# tunnel gre key 100
Switch(config-if)# ip address 192.192.168.2/24
Switch(config-if)# keepalive 5 3
Switch(config-if)# exit
```

step 4 Configure the static route and arp

Configuring Switch1:

```
Switch(config)# ip route 192.168.20.0/24 192.168.10.2
Switch(config)# ip route 192.168.12.0/24 tunnell
```

Configuring Switch2:

```
Switch(config)# ip route 192.168.10.0/24 192.168.20.2
Switch(config)# ip route 192.168.11.0/24 tunnell
```

step 5 Exit the configure mode

```
Switch(config)# end
```

step 6 Validation

Display the result on Switch1:

```
Switch# show interface tunnell
Interface tunnell
  Interface current state: UP
  Hardware is Tunnel
  Index 8193 , Metric 1 , Encapsulation TUNNEL
  VRF binding: not bound
  Internet primary address:
    192.192.168.1/24 pointopoint 192.192.168.255
  Tunnel protocol/transport GRE/IP, Status Valid
  Tunnel source 192.168.10.1(eth-0-1), destination 192.168.20.1
  Tunnel DSCP inherit, Tunnel TTL 255
  Tunnel GRE key enable: 100
  Tunnel GRE keepalive enable, Send period: 5, Retry times: 3
  0 packets input, 0 bytes
  0 packets output, 0 bytes
```

Display the result on Switch2:

```
Switch# show interface tunnell
Interface tunnell
  Interface current state: UP
  Hardware is Tunnel
  Index 8193 , Metric 1 , Encapsulation TUNNEL
  VRF binding: not bound
  Internet primary address:
    192.192.168.2/24 pointopoint 192.192.168.255
  Tunnel protocol/transport GRE/IP, Status Valid
  Tunnel source 192.168.20.1(eth-0-1), destination 192.168.10.1
  Tunnel DSCP inherit, Tunnel TTL 255
  Tunnel GRE key enable: 100
  Tunnel GRE keepalive enable, Send period: 5, Retry times: 3
  0 packets input, 0 bytes
  0 packets output, 0 bytes
```

15.2.3 Application cases

N/A

16 Reliability Configuration Guide

16.1 Configuring BHM

16.1.1 Overview

Function Introduction

BHM is a module which is used to monitor other Processes. When a monitored Process is uncontrolled, the BHM module will take measures, such as printing warning on screen, shutting all ports, or restarting the system, to help or remind users to recover the system.

The monitored Processes include RIP, RIPNG, OSPF, OSPF6, BGP, LDP, RSVP, PIM, PIM6, 802.1X, LACP MSTP, DHCP-RELAY, DHCP-RELAY6, RMON, OAM, ONM, SSH, SNMP, PTP, SSM. In addition, some system procedures are also monitored, including NSM, IMI, CHSM, HSRVD. There are three activations of BHM, including “reload system”, including “reload system”, “warning”, “shutdown port”.

Principle Description

N/A

16.1.2 Configuration

step 1 Enter the configure mode

```
Switch# configure terminal
```

step 2 Enable system monitor and heart-beat-monitor globally

```
Switch(config)# sysmon enable  
Switch(config)# heart-beat-monitor enable
```

step 3 Reload system if a monitored PM is uncontrolled

```
Switch(config)# heart-beat-monitor reactivate reload system
```



NOTE There are three activations of BHM, including "reload system", "warning", "shutdown port".

step 4 Exit the configure mode

```
Switch(config)# end
```

step 5 Validation

```
Switch# show heart-beat-monitor
heart-beat-monitor enable.
heart-beat-monitor reactivation: restart system.
```

16.1.3 Application cases

N/A

16.2 Configuring EFM OAM

16.2.1 Overview

Function Introduction

This chapter contains a complete sample EFM OAM configuration. To see details on the commands used in this example, or to see the outputs of the validation commands, refer to the OAM Command Reference. To avoid repetition, some Common commands, like configure terminal, have not been listed under the commands used sections.

The main functions of Ethernet to the First Mile - Operation Administration and Maintenance (EFM-OAM) are link performance monitoring, fault detection, fault signaling and loopback signaling. OAM information is conveyed in Slow Protocol frames called OAM Protocol Data Units (OAMPDUs). OAMPDUs contain the appropriate control and status information used to monitor, test and troubleshoot OAM-enabled links.

Principle Description

Reference: IEEE 802.3ah (2004)

16.2.2 Configuration

Configuring Enable EFM

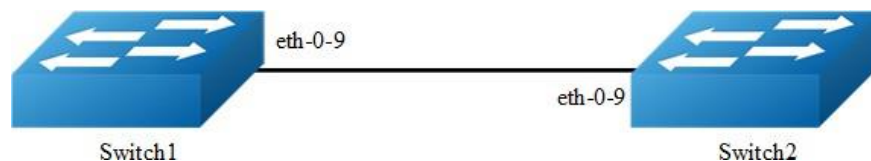

Figure 16-1 EFM

The following configurations are same on Switch1 and Switch2.

step 1 Enter the configure mode

```
Switch# configure terminal
```

step 2 Enter the interface configure mode and enable ethernet oam

```
Switch(config)# interface eth-0-9
Switch(config-if)# ethernet oam enable
Switch(config-if)# ethernet oam mode active
Switch(config-if)# ethernet oam link-monitor frame threshold high 10 window 50
Switch(config-if)# exit
```



NOTE

ethernet oam mode can be "active" or "passive". For example:

```
Switch(config-if)# ethernet oam mode passive
```

At least one switch among Switch1 and Switch2 should use mode active. Both switch use active can also work normally.

step 4 Exit the configure mode

```
Switch(config)# end
```

step 5 Validation

The EFM Discovery Machine State should be "send any" in both machines. This is the expected normal operating state for OAM on fully-operational links.

The various states of OAM discovery state machine are defined below.

- **ACTIVE_SEND_LOCAL:** A DTE configured in Active mode sends Information OAMPDUs that only contain the Local Information TLV. This state is called ACTIVE_SEND_LOCAL. While in this state, the local DTE waits for Information OAMPDUs received from the remote DTE.
- **PASSIVE_WAIT:** DTE configured in Passive mode waits until receiving Information OAMPDUs with Local Information TLVs before sending any Information OAMPDUs with Local Information TLVs. This state is called PASSIVE_WAIT. By waiting until first receiving an Information OAMPDU with the Local Information TLV, a Passive DTE cannot complete the OAM Discovery process when connected to another Passive DTE.
- **SEND_LOCAL_REMOTE:** Once the local DTE has received an Information OAMPDU with the Local Information TLV from the remote DTE, the local DTE begins sending Information OAMPDUs that contain both the Local and Remote Information TLVs. This state is called SEND_LOCAL_REMOTE.
- **SEND_LOCAL_REMOTE_OK:** If the local OAM client deems the settings on both the local and remote DTEs are acceptable, it enters the SEND_LOCAL_REMOTE_OK state.
- **SEND_ANY:** Once an OAMPDU has been received indicating the remote device is satisfied with the respective settings, the local device enters the SEND_ANY state. This is the expected normal operating state for OAM on fully operational links.
- **FAULT:** If OAM is reset, disabled, or the link timer expires, the Discovery process returns to the FAULT state.

Display results on Switch1:

```
Switch# show ethernet oam discovery interface eth-0-9
eth-0-9
Local client:
-----
Administrative configurations:
  Mode:                               active
  Unidirection:                       not supported
  Link monitor:                       supported(on)
  Remote Loopback:                   not supported
  MIB retrieval:                     not supported
  MTU Size      :                     1518
Operational status:
  Port status:                       send any
  Loopback status:                   no loopback
```

```

PDU revision: 1
Remote client:
-----
MAC address: e6c2.47f6.7809
PDU revision: 1
Vendor(oui): e6 c2 47
Administrative configurations:
  Mode: active
  Unidirection: not supported
  Link monitor: supported
  Remote Loopback: not supported
  MIB retrieval: not supported
  MTU Size : 1518

```

Display results on Switch2:

```

Switch# show ethernet oam discovery interface eth-0-9
eth-0-9
Local client:
-----
Administrative configurations:
  Mode: active
  Unidirection: not supported
  Link monitor: supported(on)
  Remote Loopback: not supported
  MIB retrieval: not supported
  MTU Size : 1518
Operational status:
  Port status: operational
  Loopback status: no loopback
  PDU revision: 1
Remote client:
-----
MAC address: 409c.bala.5a09
PDU revision: 1
Vendor(oui): 40 9c ba
Administrative configurations:
  Mode: active
  Unidirection: not supported
  Link monitor: supported
  Remote Loopback: not supported
  MIB retrieval: not supported
  MTU Size : 1518

```

Configuring Remote Loopback

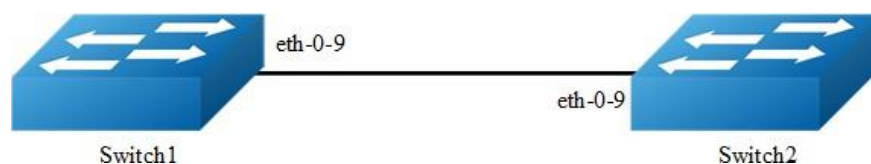

Figure 16-2 EFM

OAM remote loopback can be used for fault localization and link performance testing. In addition, an implementation may analyze loopback frames within the OAM sublayer to determine additional information about the health of the link (i.e. determine which frames are being dropped due to link errors).

The following configurations are same on Switch1 and Switch2 if there is no special description.

step 1 Enter the configure mode

```
Switch# configure terminal
```

step 2 Enter the interface configure mode and enable ethernet oam remote loopback

```
Switch(config)# interface eth-0-9
Switch(config-if)# ethernet oam enable
Switch(config-if)# ethernet oam remote loopback supported
Switch(config-if)# exit
```

step 3 Exit the configure mode

```
Switch(config)# end
```

step 4 Start remote loopback

Configure on Switch1:

```
Switch# ethernet oam remote-loopback start interface eth-0-9
```

step 5 Validation

Display results on Switch1:

```
Switch# show ethernet oam state-machine interface eth-0-9
State Machine Details:
-----
Local OAM mode:                Active
Local OAM enable:              Enable
Local link status:              OK
Local pdu status:              ANY
Local Satisfied:               True
Local Stable:                  True
Remote Satisfied valid:        True
Remote Stable:                 True
Local Parser State:            Discard
Local Multiplexer State:       Forward
```

```
Remote Parser State:      Loopback
Remote Multiplexer State: Discard
```

Configuring Link Monitoring Event

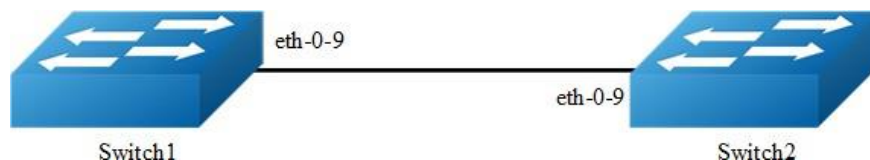

Figure 16-3 EFM

We can configure high and low threshold for link-monitoring features. We can also configure an error disable action if one of the high thresholds is exceeded.

The following configurations and validations are operated on Switch1:

step 1 Enter the configure mode

```
Switch# configure terminal
```

step 2 Enter the interface configure mode and set the threshold for error packetes

```
Switch(config)#interface eth-0-9
Switch(config-if)# ethernet oam link-monitor frame threshold high 5000 low 200
window 500
Switch(config-if)# ethernet oam link-monitor frame-seconds threshold high 600 low
200 window 9000
```



NOTE The "ethernet oam link-monitor frame threshold" command specifies the high and low thresholds of error packets in a period. The period is defined by arguments "window 500", the unit is 100 millisecond, the default value is 1 second. In this case the high threshold is 5000 packets and the low threshold is 200 packets.

The "ethernet oam link-monitor frame-seconds threshold" command specifies the high and low thresholds of the seconds which have error packets in a period. The period is defined by arguments "window 9000", the unit is 100 millisecond, the default value is 100 second. In this case the high threshold is 600 seconds and the low threshold is 200 seconds.

step 3 Set the action when reach the threshold

When the error packets exceed the threshold configured in step 2, set the interface status to error-disable

```
Switch(config-if)# ethernet oam link-monitor high-threshold action error-disable-
interface
Switch(config-if)# exit
```

step 4 Exit the configure mode

```
Switch(config)# end
```

step 5 Validation

```
Switch#show ethernet oam status interface eth-0-9
eth-0-9
General:

Mode:                               active
PDU max rate:                        1 packets per second
PDU min rate:                        1 packet per 1 second
Link timeout:                        10 seconds
High threshold action:               disable interface
Link fault action:                   no action
Dying gasp action:                   no action
Critical event action:                no action
Link Monitoring:

Status:                               supported(on)
Frame Error:
  Window:                             500 x 100 milliseconds
  Low threshold:                       200 error frame(s)
  High threshold:                      5000 error frame(s)
  Last Window Frame Errors:             0 Frame(s)
  Total Frame Errors:                   0 Frame(s)
  Total Frame Errors Events:            0 Events(s)
  Relative Timestamp of the Event:      0 x 100 milliseconds
Frame Seconds Error:
  Window:                              9000 x 100 milliseconds
  Low threshold:                       200 error second(s)
  High threshold:                      600 error second(s)
  Last Window Frame Second Errors:      0 error second(s)
  Total Frame Second Errors:            0 error second(s)
  Total Frame Second Errors Events:     0 Events(s)
  Relative Timestamp of the Event:      0 x 100 milliseconds
```

Configuring Remote Failure Detection

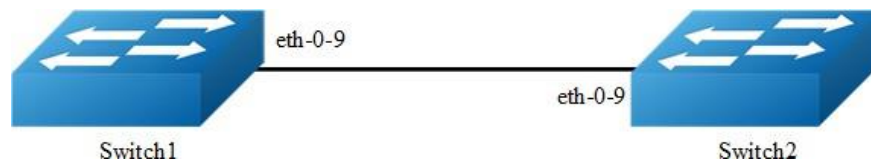

Figure 16-4 EFM

An error-disable action can be configured to occur on an interface so that if any of the critical link events (link fault, dying gasp, etc.) occurs in the remote machine, the interface is shut down.

The following configurations and validations are operated on Switch1:

step 1 Enter the configure mode

```
Switch# configure terminal
```

step 2 Enter the interface configure mode and set action when the remote link failure

```
Switch(config)#interface eth-0-9  
Switch(config-if)# ethernet oam remote-failure critical-event dying-gasp link-fault  
action error-disable-interface  
Switch(config-if)# exit
```

step 3 Exit the configure mode

```
Switch(config)# end
```

16.2.3 Application cases

N/A

16.3 Configuring CFM

16.3.1 Overview

Function Introduction

CFM = Connectivity Fault Management

CFM provides the capability to detect, verify, isolate and notify connectivity failures on a Virtual Bridged LAN based on the protocol standard specified in IEEE 802.1ag. It provides for discovery and verification of paths through 802.1 bridges and LANs, and is part of the enhanced Operation, Administration and Management (OAM) features. CFM is designed to be transparent to the customer data transported by a network and to be capable of providing maximum fault coverage.

Principle Description

Reference: IEEE 802.1ag/D8.1

CFM uses standard Ethernet frames distinguished by EtherType. These CFM messages are supported:

Continuity Check messages (CC)

Multicast heartbeat messages exchanged periodically between MEPs that allow MEPs to discover other MEPs within a domain and allow MIPs to discover MEPs. It is used to detect loss of continuity (LOC) between any pair of MEPs.

Loopback messages

Unicast frames transmitted by an MEP at administrator request to verify connectivity to a particular maintenance point, indicating if a destination is reachable. A loopback message is similar to an Internet Control Message Protocol (ICMP) ping message.

Linktrace messages

Multicast frames transmitted by an MEP at administrator request to track the path (hop-by-hop) to a destination MEP/MIP. Traceroute messages are similar in concept to UDP traceroute messages.

Delay Measurement messages

A MEP sends DMM with ETH-DM request information to its peer MEP and receives DMR with ETH-DM reply information from its peer MEP to carry out two-way frame delay and delay variation measurements.

When a MEP receives 1DM frames, it will carry out one-way frame delay and delay variation measurements.

Ethernet Locked Signal messages

Ethernet Locked Signal function (ETH-LCK) is used to communicate the administrative locking of a server (sub) layer MEP and consequential interruption of data traffic forwarding towards the MEP expecting this traffic. It allows a MEP receiving frames with ETH-LCK information to differentiate between a defect condition and an administrative locking action at the server (sub) layer MEP.

Ethernet client signal fail messages

The Ethernet client signal fail function (ETH-CSF) is used by a MEP to propagate to a peer MEP the detection of a failure or defect event in an Ethernet client signal when the client itself does not support appropriate fault or defect detection or propagation mechanisms, such as ETH-CC or ETH-AIS. The ETH-CSF messages propagate in the direction from the Ethernet source-adaptation function detecting the failure or defect event to the Ethernet sink-adaptation function associated with the peer MEP. ETH-CSF is only applicable to point-to-point Ethernet transport applications.

Ethernet Frame loss measurement message

ETH-LM is used to collect counter values applicable for ingress and egress service frames where the counters maintain a count of transmitted and received data frames between a pair of MEPs.

ETH-LM is performed by sending LMM with ETH-LM information to a peer MEP and similarly receiving LMR with ETH-LM information from the peer MEP.

16.3.2 Configuration



CFM is conflict with 802.1x and mirror destination on the same port. Therefore, CFM and these functions should not be configured on the same port.

Configure CC/LB/LT/AIS/DM

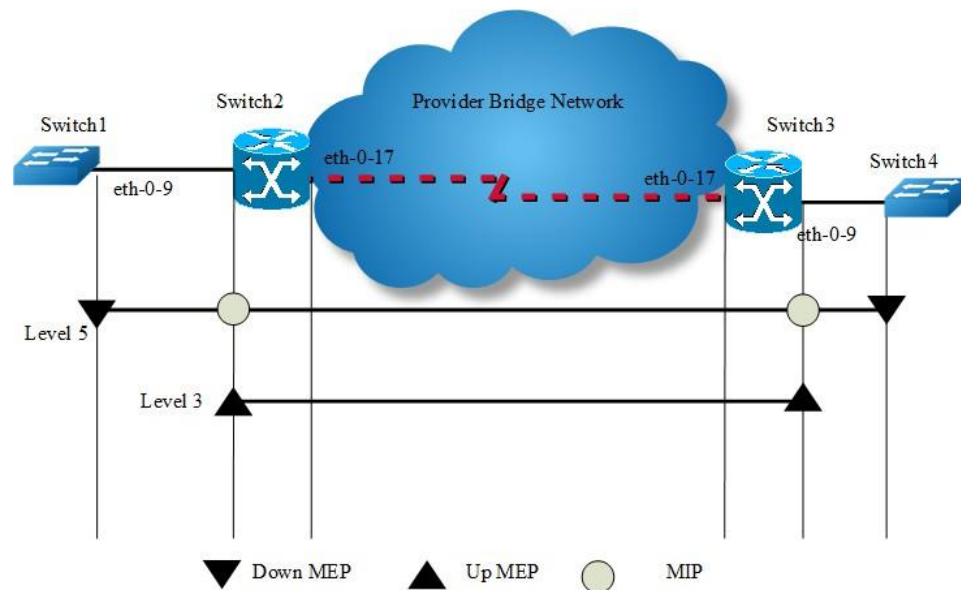

Figure 16-5 CFM

The following configuration should be operated on all switches if the switch ID is not specified.

step 1 Enter the configure mode

```
Switch# configure terminal
```

step 2 Enter the vlan configure mode and create the vlan

```
Switch(config)# vlan database
Switch(config-vlan)# vlan 30
Switch(config-vlan)# exit
```

step 3 Enable CFM globally and set cfm mode to y1731

```
Switch(config)# ethernet cfm enable
Switch(config)# ethernet cfm mode y1731
```

step 4 Create the cfm domain and bind the service with a vlan

Create a domain which has the name "cust" and level 5.

```
Switch(config)# ethernet cfm domain cust level 5
Switch(config-ether-cfm)# service cst vlan 30
Switch(config-ether-cfm)# exit
```

Create a domain which has the name "provid" and level 3.

Configuring Switch2 and Switch3:

```
Switch(config)# ethernet cfm domain provid level 3
Switch(config-ether-cfm)# service cst vlan 30
Switch(config-ether-cfm)# exit
```



NOTE

The range of the cfm domain level should be 0-7. The larger number indicates the higher priority. When different cfm domains have the same vlan, the packets of the domain with higher priority can pass through the domains with lower priority.

step 5 Enter the interface configure mode and set the attributes of the interface

Interface configuration for Switch1:

```
Switch(config)# interface eth-0-9
Switch(config-if)# switchport mode trunk
Switch(config-if)# switchport trunk allowed vlan add 30
Switch(config-if)# ethernet cfm mep down mpid 66 domain cust vlan 30 interval 1
Switch(config-if)# ethernet cfm mep crosscheck mpid 99 domain cust vlan 30 mac
d036.4567.8009
Switch(config-if)# no shutdown
Switch(config-if)# exit
```

Interface configuration for Switch2:

```
Switch(config)# interface eth-0-9
Switch(config-if)# switchport mode trunk
Switch(config-if)# switchport trunk allowed vlan add 30
Switch(config-if)# ethernet cfm mip level 5 vlan 30
Switch(config-if)# ethernet cfm mep up mpid 666 domain provid vlan 30 interval 1
Switch(config-if)# ethernet cfm mep crosscheck mpid 999 domain provid vlan 30 mac
6a08.051e.bd09
Switch(config-if)# ethernet cfm ais status enable all domain provid vlan 30 level 5
multicast
Switch(config-if)# ethernet cfm server-ais status enable level 5 interval 1
Switch(config-if)# no shutdown
Switch(config-if)# exit

Switch(config)# interface eth-0-17
Switch(config-if)# switchport mode trunk
Switch(config-if)# switchport trunk allowed vlan add 30
Switch(config-if)# no shutdown
Switch(config-if)# exit
```

Interface configuration for Switch3:

```
Switch(config)# interface eth-0-9
Switch(config-if)# switchport mode trunk
```



```
Switch(config-if)# switchport trunk allowed vlan add 30
Switch(config-if)# ethernet cfm mip level 5 vlan 30
Switch(config-if)# ethernet cfm mep up mpid 999 domain provid vlan 30 interval 1
Switch(config-if)# ethernet cfm mep crosscheck mpid 666 domain provid vlan 30 mac
0e1d.a7d7.fb09
Switch(config-if)# no shutdown
Switch(config-if)# exit
Switch(config)# interface eth-0-17
Switch(config-if)# switchport mode trunk
Switch(config-if)# switchport trunk allowed vlan add 30
Switch(config-if)# no shutdown
Switch(config-if)# exit
```

Interface configuration for Switch4:

```
Switch(config)# interface eth-0-9
Switch(config-if)# switchport mode trunk
Switch(config-if)# switchport trunk allowed vlan add 30
Switch(config-if)# ethernet cfm mep down mpid 99 domain cust vlan 30 interval 1
Switch(config-if)# ethernet cfm mep crosscheck mpid 66 domain cust vlan 30 mac
fa02.cdff.6a09
Switch(config-if)# no shutdown
Switch(config-if)# exit
```

step 6 Enable continuity check

Configuring Switch1 and Switch4:

```
Switch1(config)# ethernet cfm cc enable domain cust vlan 30
```

Configuring Switch2 and Switch3:

```
Switch2(config)# ethernet cfm cc enable domain provid vlan 30
```

step 7 Alarm configuration (optional)

Suppress errors when ais packet is received and loc error.

Configuring Switch1:

```
Switch(config)# ethernet cfm ais suppress alarm enable domain cust vlan 30
```

step 8 Exit the configure mode

```
Switch(config)# end
```

step 9 Validation

MEP and MIP checks

The following command gives the connectivity details of the local machine Switch1 and Switch2 for the configured domain.

Switch1:

```
Switch# show ethernet cfm maintenance-points
#####Local MEP:
MPID Direction DOMAIN LEVEL TYPE VLAN PORT      CC-Status Mac-address  RDI
Interval
-----
---
66  Down MEP      cust   5      MEP 30   eth-0-9  enabled  fa02.cdff.6a09 True
3.33ms
#####Local MIP:
Level  VID  TYPE  PORT      MAC
-----
#####Remote MEP:
MPID  LEVEL VLAN ACTIVE Remote Mac      RDI  FLAGS  STATE
-----
99    5    30   Yes    d036.4567.8009 True  Learnt  UP
```

Switch2:

```
Switch# show ethernet cfm maintenance-points
#####Local MEP:
MPID Direction DOMAIN LEVEL TYPE VLAN PORT      CC-Status Mac-address  RDI
-----
666 Up  MEP      provid 3      MEP 30   eth-0-9  enabled  0e1d.a7d7.fb09 False
#####Local MIP:
Level  VID  TYPE  PORT      MAC
-----
5      30   MIP   eth-0-9    0e1d.a7d7.fb09
#####Remote MEP:
MPID  LEVEL VLAN ACTIVE Remote Mac      RDI  FLAGS  STATE
-----
999   3    30   Yes    6a08.051e.bd09 True  Learnt  UP
```

Loopback checks

The following command is used to ping remote mep by remote mep unicast mac address on Switch1.

```
Switch# ethernet cfm loopback mac d036.4567.8009 unicast mepid 66 domain cust vlan
30
Sending 1 Ethernet CFM loopback messages, timeout is 5 seconds:
(! Pass . Fail)
!
Loopback completed.
```

```
-----
Success rate is 100 percent(1/1)
```

The following command is used to ping remote mep by multicast mac address on Switch1.

```
Switch# ethernet cfm loopback multicast mepid 66 domain cust vlan 30
Sending 1 Ethernet CFM loopback messages, timeout is 5 seconds:
(! Pass . Fail)
Host MEP: 66
Number of RMEPs that replied to mcast frame = 1
LBR received from the following
    9667.bb68.f308
success rate is 100 (1/1)
```

The following command is used to ping remote mep by remote mep id on Switch1.

```
Switch# ethernet cfm loopback unicast rmepid 99 mepid 66 domain cust vlan 30
Sending 1 Ethernet CFM loopback messages, timeout is 5 seconds:
(! Pass . Fail)
!
Loopback completed.
-----
Success rate is 100 percent(1/1)
```

The following command is used to ping mip by mip mac address on Switch1.

```
Switch# ethernet cfm loopback mac 0e1d.a7d7.fb09 unicast mepid 66 domain cust vlan
30
Sending 1 Ethernet CFM loopback messages, timeout is 5 seconds:
(! Pass . Fail)
!
Loopback completed.
-----
Success rate is 100 percent(1/1)
```

RDI checks

Before clear local mep rdi, the rdi status on Switch1 is as follows:

```
Switch# show ethernet cfm maintenance-points local mep domain cust
MPID Direction DOMAIN LEVEL TYPE VLAN PORT      CC-Status Mac-address      RDI Interval
-----
66   Down MEP   cust   5   MEP   30   eth-0-9   enabled   fa02.cdff.6a09 True 3.33ms
```

ERROR checks

Before clear local mep errors, the errors on Switch1 are as follows:

```
Switch# show ethernet cfm errors domain cust
Level Vlan MPID RemoteMac      Reason
5      30   66   d036.4567.8009 errorCCMdefect: rmep not found      cst
5      30   66   d036.4567.8009 errorCCMdefect: rmep not found clear cst
Time
```

```
2011/05/27 3:19:18
2011/05/27 3:19:32
```

The following command is used to clear errors on Switch1.

```
Switch# clear ethernet cfm errors domain cust
```

After clear local mep errors, the errors on Switch1 are as follows:

```
Switch# clear ethernet cfm errors domain cust
Level Vlan MPID RemoteMac      Reason      ServiceId
```

AIS check

The following command is used to disable cc function in Switch1.

```
Switch(config)# no ethernet cfm cc enable domain cust vlan 30
```

The following command is used to disable cc function in Switch3.

```
Switch(config)# no ethernet cfm cc enable domain cust vlan 30
```

The following command is used to check ais defect condition in Switch2.

```
Switch# show ethernet cfm ais mep 666 domain cust vlan 30
AIS-Status: Enabled
AIS Period: 1
Level to transmit AIS: 7
AIS Condition: No
```

Configured defect condition	detected(yes/no)
unexpected-period	no
unexpected-MEG level	no
unexpected-MEP	no
Mismerge	no
LOC	yes

The following command is used to check ais reception status in Switch1.

```
Switch# show ethernet cfm ais mep 66 domain cust vlan 30
AIS-Status: Disabled
AIS Condition: Yes
```

LinkTrace checks

The following command is used to link trace remote mep by remote mep unicast mac address on Switch1.

```
Switch# ethernet cfm linktrace mac d036.4567.8009 mepid 66 domain cust vlan 30
Sending Ethernet CFM linktrace messages,TTL is 64.Per-Hop Timeout is 5 seconds:
Please wait a moment
```

```
-----
Received Hops: 1
-----
```

```

TTL : 63
Fowarded : True
Terminal MEP : False
Relay Action : Rly FDB
Ingress Action : IngOk
Ingress MAC address : 0e1d.a7d7.fb09
Ingress Port ID Type : ifName
Ingress Port ID : eth-0-9

```

```
-----
Received Hops: 2

```

```

TTL : 62
Fowarded : True
Terminal MEP : False
Relay Action : Rly FDB
Egress Action : EgrOk
Egress MAC address : 6a08.051e.bd09
Egress Port ID Type : ifName
Egress Port ID : eth-0-9

```

```
-----
Received Hops: 3

```

```

TTL : 61
Fowarded : False
Terminal MEP : True
Relay Action : Rly Hit
Ingress Action : IngOk
Ingress MAC address : d036.4567.8009
Ingress Port ID Type : ifName
Ingress Port ID : eth-0-9

```

The following command is used to link trace remote mep by remote mep id on Switch1.

```

Switch# ethernet cfm linktrace rmepid 99 mepid 66 domain cust vlan 30
Sending Ethernet CFM linktrace messages,TTL is 64.Per-Hop Timeout is 5 seconds:
Please wait a moment

```

```
-----
Received Hops: 1

```

```

TTL : 63
Fowarded : True
Terminal MEP : False
Relay Action : Rly FDB
Ingress Action : IngOk
Ingress MAC address : 0e1d.a7d7.fb09
Ingress Port ID Type : ifName
Ingress Port ID : eth-0-9

```

```
-----
Received Hops: 2

```

```

TTL : 62
Fowarded : True
Terminal MEP : False
Relay Action : Rly FDB

```

```
Egress Action          : EgrOk
Egress MAC address     : 6a08.051e.bd09
Egress Port ID Type    : ifName
Egress Port ID        : eth-0-9
```

```
-----
Received Hops: 3
-----
```

```
TTL                    : 61
Fowarded               : False
Terminal MEP           : True
Relay Action           : Rly Hit
Ingress Action         : IngOk
Ingress MAC address    : d036.4567.8009
Ingress Port ID Type  : ifName
Ingress Port ID       : eth-0-9
```

The following command is used to link trace remote mip by remote mip unicast mac address on Switch1.

```
Switch# ethernet cfm linktrace 6a08.051e.bd09 mepid 66 domain cust vlan 30
Sending Ethernet CFM linktrace messages,TTL is 64.Per-Hop Timeout is 5 seconds:
Please wait a moment
```

```
-----
Received Hops: 1
-----
```

```
TTL                    : 63
Fowarded               : True
Terminal MEP           : False
Relay Action           : Rly FDB
Ingress Action         : IngOk
Ingress MAC address    : 0e1d.a7d7.fb09
Ingress Port ID Type  : ifName
Ingress Port ID       : eth-0-9
```

```
-----
Received Hops: 2
-----
```

```
TTL                    : 62
Fowarded               : False
Terminal MEP           : False
Relay Action           : Rly Hit
Egress Action         : EgrOk
Egress MAC address     : 6a08.051e.bd09
Egress Port ID Type    : ifName
Egress Port ID        : eth-0-9
```

1DM and DMM checks

The following command is used to make two way delay and delay variation measurement on Switch1.

```
Switch# ethernet cfm dmm rmepid 99 mepid 66 count 5 domain cust vlan 30
Delay measurement statistics:
  DMM Packets transmitted      : 5
  Valid DMR packets received  : 5
```

Index	Two-way delay	Two-way delay variation
1	4288 usec	0 usec
2	4312 usec	24 usec
3	4296 usec	16 usec
4	4320 usec	24 usec
5	4264 usec	56 usec
Average delay		: 4296 usec
Average delay variation		: 24 usec
Best case delay		: 4264 usec
Worst case delay		: 4320 usec

Before make one way delay measurement, clock timer should be synchronized. The following command is used to start sending 1dm message in Switch1.

```
Switch1#ethernet cfm ldm rmepid 99 mepid 66 count 5 domain cust vlan 30
```

The following is 1dm test result in Switch4.

```
Switch4# show ethernet cfm delaymeasurement cache
Remote MEP      : 66
Remote MEP vlan : 30
Remote MEP level : 5
DMM Packets transmitted      : 0
Valid DMR packets received   : 0
Valid 1DM packets received   : 5
Index  One-way delay  One-way delay variation  Received Time
  1    16832 usec          0 usec      2011/07/19 17:27:46
  2    16176 usec         656 usec      2011/07/19 17:27:47
  3    15448 usec         728 usec      2011/07/19 17:27:48
  4    14800 usec         648 usec      2011/07/19 17:27:49
  5    15406 usec         606 usec      2011/07/19 17:27:50
Average delay                : 15732 usec
Average delay variation      : 527 usec
Best case delay              : 14800 usec
Worst case delay             : 16832 usec
```

Configure LCK

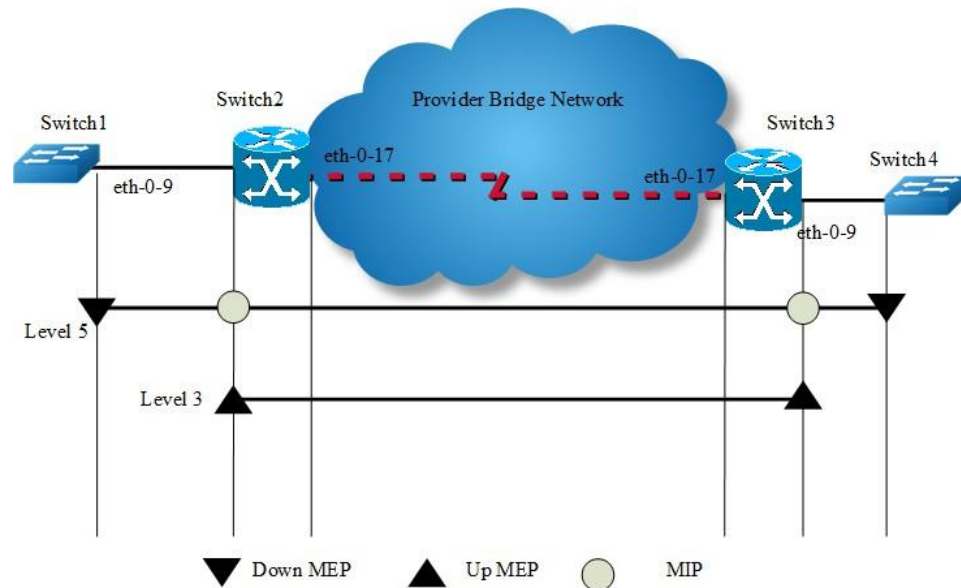

Figure 16-6 CFM

step 1 Configuration prepare

Reference to the chapter "Configure CC/LB/LT/AIS/DM".

step 2 Configure LCK

Configuring Switch2:

```
Switch(config)# interface eth-0-9
Switch(config-if)# ethernet cfm lck enable mep 666 domain provid vlan 30 tx-level 5
interval 1
```

step 3 Validation

The following command is used to display lck status for Switch2:

```
Switch2# show ethernet cfm lck
En-LCK Enable, Y(Yes)/N(No)
Rx-LC, Receive LCK packets and enter LCK condition, Y(Yes)/N(No)
Rx-I, The period which is gotten from LCK packets
Tx-Domain, frames with ETH-LCK information are sent to this Domain
Tx-I, Transmit Interval
```

MPID	Domain	VLAN	En	Rx-LC	Rx-I	Tx-Domain	Tx-I
666	provid	30	Y	N	N/A	cust	1

The following command is used to display lck status for Switch1:

```
Switch1# show ethernet cfm lck
En-LCK Enable, Y(Yes)/N(No)
Rx-LC, Receive LCK packets and enter LCK condition, Y(Yes)/N(No)
Rx-I, The period which is gotten from LCK packets
Tx-Domain, frames with ETH-LCK information are sent to this Domain
Tx-I, Transmit Interval
-----
MPID Domain      VLAN En Rx-LC Rx-I Tx-Domain    Tx-I
-----
66  cust         30  N  Y   1   N/A      N/A
```

Configure CSF

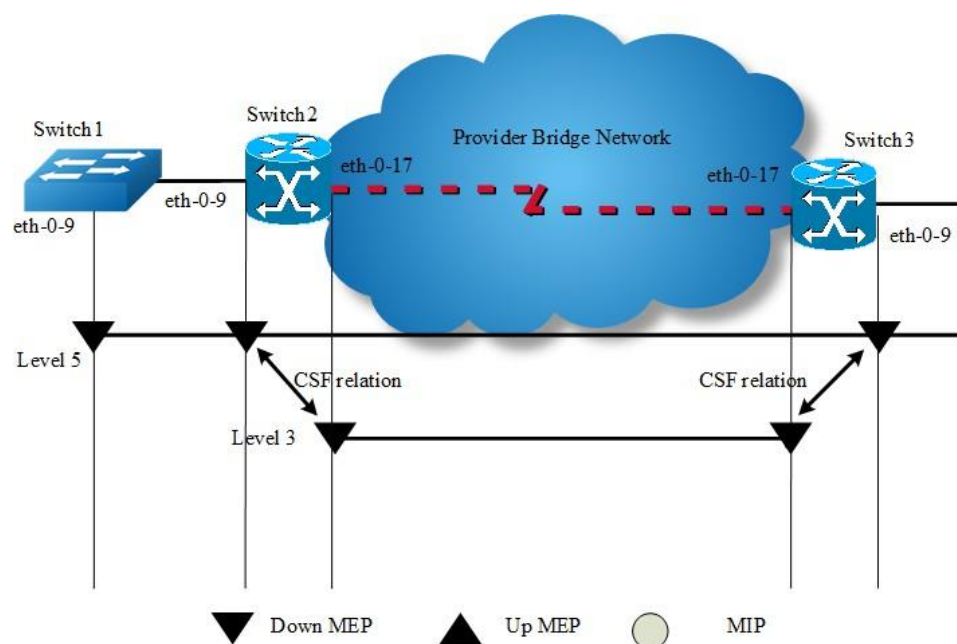

Figure 16-7 CFM CSF

The following configuration should be operated on all switches if the switch ID is not specified.

step 1 Enter the configure mode

```
Switch# configure terminal
```

step 2 Enter the vlan configure mode and create the vlan

Configuring Switch1:

```
Switch(config)# vlan database
Switch(config vlan)# vlan 30
Switch(config vlan)# exit
```

Configuring Switch2 and Switch3:

```
Switch3(config)# vlan database
Switch3(config vlan)# vlan 20,30
Switch3(config vlan)# exit
```

step 3 Enable CFM globally and set cfm mode to y1731

```
Switch(config)# ethernet cfm enable
Switch(config)# ethernet cfm mode y1731
```

step 4 Create the cfm domain and bind the service with a vlan

Create a domain which has the name "cust" and level 5.

```
Switch(config)# ethernet cfm domain cust level 5
Switch(config-ether-cfm)# service cst vlan 30
Switch(config-ether-cfm)# exit
```

Create a domain which has the name "provid" and level 3.

Configuring Switch2 and Switch3:

```
Switch(config)# ethernet cfm domain provid level 3
Switch(config-ether-cfm)# service cst vlan 20
Switch(config-ether-cfm)# exit
```

step 5 Enter the interface configure mode and set the attributes of the interface

Interface configuration for Switch1:

```
Switch(config)# interface eth-0-9
Switch(config-if)# switchport mode trunk
Switch(config-if)# switchport trunk allowed vlan add 30
Switch(config-if)# ethernet cfm mep down mpid 66 domain cust vlan 30 interval 1
Switch(config-if)# ethernet cfm mep crosscheck mpid 99 domain cust vlan 30 mac
d036.4567.8009
Switch(config-if)# no shutdown
Switch(config-if)# exit
```

Interface configuration for Switch2:

```
Switch(config)# interface eth-0-9
Switch(config-if)# switchport mode trunk
Switch(config-if)# switchport trunk allowed vlan add 30
Switch(config-if)# ethernet cfm mep down mpid 99 domain cust vlan 30 interval 1
Switch(config-if)# ethernet cfm mep crosscheck mpid 66 domain cust vlan 30 mac
fa02.cdff.6a09
Switch(config-if)# no shutdown
```

```
Switch(config-if)# exit

Switch(config)#interface eth-0-17
Switch(config-if)# switchport mode trunk
Switch(config-if)# switchport trunk allowed vlan add 20
Switch(config-if)# ethernet cfm mep down mpid 666 domain provid vlan 20 interval 1
Switch(config-if)# no shutdown
Switch(config-if)# exit
```

Interface configuration for Switch3:

```
Switch(config)# interface eth-0-9
Switch(config-if)# switchport mode trunk
Switch(config-if)# switchport trunk allowed vlan add 30
Switch(config-if)# ethernet cfm mep down mpid 88 domain cust vlan 30 interval 1
Switch(config-if)# no shutdown
Switch(config-if)# exit

Switch(config)#interface eth-0-17
Switch(config-if)# switchport mode trunk
Switch(config-if)# switchport trunk allowed vlan add 20
Switch(config-if)# ethernet cfm mep down mpid 999 domain provid vlan 20 interval 1
Switch(config-if)# no shutdown
Switch(config-if)# exit
```

step 6 Enable continuity check

```
Switch(config)# ethernet cfm cc enable domain cust vlan 30
```

step 7 Configure csf relation between client mep and server mep

Configuring Switch2:

```
Switch(config)# ethernet cfm csf client domain cust vlan 30 mepid 99 server domain
provid vlan 20 mepid 666 interval 1
```

Configuring Switch3:

```
Switch(config)# ethernet cfm csf client domain cust vlan 30 mepid 88 server domain
provid vlan 20 mepid 999 interval 1
```

step 8 Validation

The following command is used to disable cc function in Switch1.

```
Switch (config)#no ethernet cfm cc enable domain cust vlan 30
```

For Switch2, client MEP 99 will report loc error and trigger csf for reason los, therefore server MEP 666 will send CSF packet in interval 1 second. The following command is used to display csf status for Swtich2.

```
Switch# show ethernet cfm csf
CTR-Client Trigger reason, L(los)/F(fdi)/R(rdi)/D(dci) or N/A
ECC-Enter CSF Condition, Y(Yes)/N(No)
SRR-Server Rx Reason, L(los)/F(fdi)/R(rdi)/D(dci) or N/A
Tx-I, Transmit Interval
Rx-I, The period which is gotten from CSF packets
```

Client Mep				Server Mep				Tx-I	Rx-I	
MPID	Cli-Domain	VLAN	CTR	ECC	MPID	Srv-Domain	VLAN	SRR	Tx-I	Rx-I
99	cust	30	L	N	666	provid	20	N/A	1	N/A

For Switch3, server MEP 999 receives CSF packet and informs client MEP 99, then client MEP 88 will enter CSF condition. The following command is used to display csf status for Switch3:

```
Switch3# show ethernet cfm csf
CTR-Client Trigger reason, L(los)/F(fdi)/R(rdi)/D(dci) or N/A
ECC-Enter CSF Condition, Y(Yes)/N(No)
SRR-Server Rx Reason, L(los)/F(fdi)/R(rdi)/D(dci) or N/A
Tx-I, Transmit Interval
Rx-I, The period which is gotten from CSF packets
```

Client Mep				Server Mep				Tx-I	Rx-I	
MPID	Cli-Domain	VLAN	CTR	ECC	MPID	Srv-Domain	VLAN	SRR	Tx-I	Rx-I
88	cust	30	N/A	Y	999	provid	20	L	1	1

Configure Dual-Ended LM

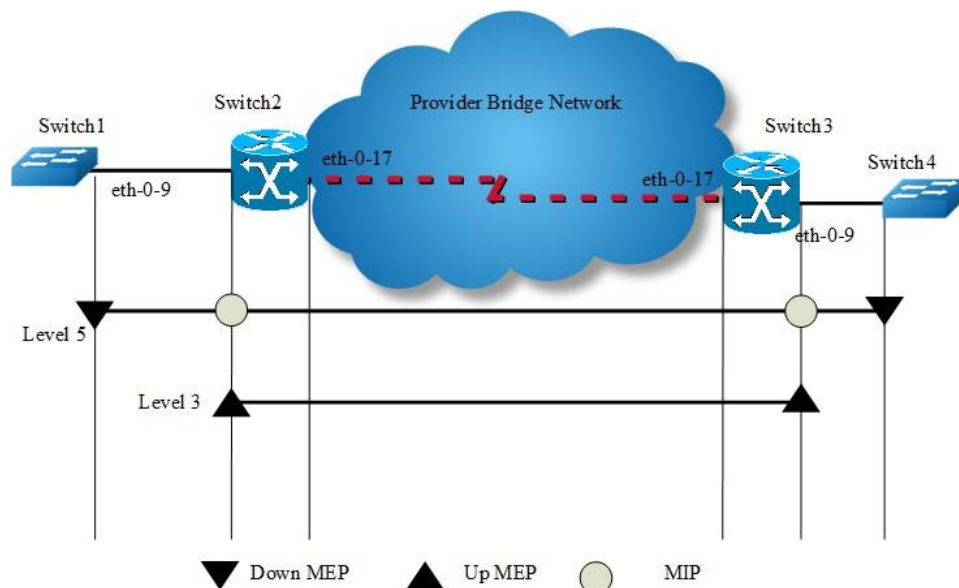

Figure 16-8 CFM

step 1 Configuration prepare

Reference to the chapter "Configure CC/LB/LT/AIS/DM".

step 2 Configure Dual-Ended LM

Configuring Switch1:

```
Switch(config)# ethernet cfm lm enable dual-ended domain cust vlan 30 mepid 66 all-  
cos cache-size 10
```

Configuring Switch4:

```
Switch(config)# ethernet cfm lm enable dual-ended domain cust vlan 30 mepid 99 all-  
cos cache-size 10
```

step 3 Validation

The following command is used to display lm status for Switch1.

```
Switch# show ethernet cfm lm domain cust vlan 30 mepid 66
DOMAIN      : cust
VLAN        : 30
MEPID       : 66
Start Time  : 2013/07/16 1:36:56
End Time    : 2013/07/16 1:37:07
Notes       : 1. When the difference of Tx is less than the difference of Rx,
              the node is invalid, loss and loss ratio should be "-";
              2. When loc is reported for mep, the loss should be "-" and loss
              ratio should be 100%;
              3. When calculate average loss and loss ratio, invalid or loc nodes
              will be excluded;
Latest dual-ended loss statistics:
-----
Index Cos Local-loss Local-loss ratio Remote-loss Remote-loss ratio Time
-----
1    all          000.0000%          0          000.0000% 01:36:57
2    all          000.0000%          0          000.0000% 01:36:58
3    all          000.0000%          0          000.0000% 01:36:59
4    all          000.0000%          0          000.0000% 01:37:00
5    all          000.0000%          0          000.0000% 01:37:01
6    all          000.0000%          0          000.0000% 01:37:02
7    all          000.0000%          0          000.0000% 01:37:03
8    all          000.0000%          0          000.0000% 01:37:04
9    all          000.0000%          0          000.0000% 01:37:05
10   all          000.0000%          0          000.0000% 01:37:07
-----
Maximum Local-loss : 0          Maximum Local-loss Ratio : 000.0000%
Minimum Local-loss : 0          Minimum Local-loss Ratio : 000.0000%
Average Local-loss  : 0          Average Local-loss Ratio : 000.0000%
Maximum Remote-loss : 0          Maximum Remote-loss Ratio : 000.0000%
```

```
Minimum Remote-loss : 0           Minimum Remote-loss Ratio : 000.0000%
Average Remote-loss : 0           Average Remote-loss Ratio : 000.0000%
```

The following command is used to display lm status for Switch4.

```
Switch# show ethernet cfm lm domain cust vlan 30 mepid 99
DOMAIN      : cust
VLAN        : 30
MEPID       : 99
Start Time  : 2013/07/16 1:37:11
End Time    : 2013/07/16 1:37:22
Notes       : 1. When the difference of Tx is less than the difference of Rx,
              the node is invalid, loss and loss ratio should be "-";
              2. When loc is reported for mep, the loss should be "-" and loss
              ratio should be 100%;
              3. When calculate average loss and loss ratio, invalid or loc nodes
              will be excluded;
Latest dual-ended loss statistics:
-----
Index Cos Local-loss Local-loss ratio Remote-loss Remote-loss ratio Time
-----
1    all                000.0000%           0           000.0000% 01:37:12
2    all                000.0000%           0           000.0000% 01:37:13
3    all                000.0000%           0           000.0000% 01:37:14
4    all                000.0000%           0           000.0000% 01:37:16
5    all                000.0000%           0           000.0000% 01:37:17
6    all                000.0000%           0           000.0000% 01:37:18
7    all                000.0000%           0           000.0000% 01:37:19
8    all                000.0000%           0           000.0000% 01:37:20
9    all                000.0000%           0           000.0000% 01:37:21
10   all                000.0000%           0           000.0000% 01:37:22
-----
Maximum Local-loss  : 0           Maximum Local-loss Ratio : 000.0000%
Minimum Local-loss  : 0           Minimum Local-loss Ratio : 000.0000%
Average Local-loss  : 0           Average Local-loss Ratio : 000.0000%
Maximum Remote-loss : 0           Maximum Remote-loss Ratio : 000.0000%
Minimum Remote-loss : 0           Minimum Remote-loss Ratio : 000.0000%
Average Remote-loss : 0           Average Remote-loss Ratio : 000.0000%
```

Configure Single-Ended LM

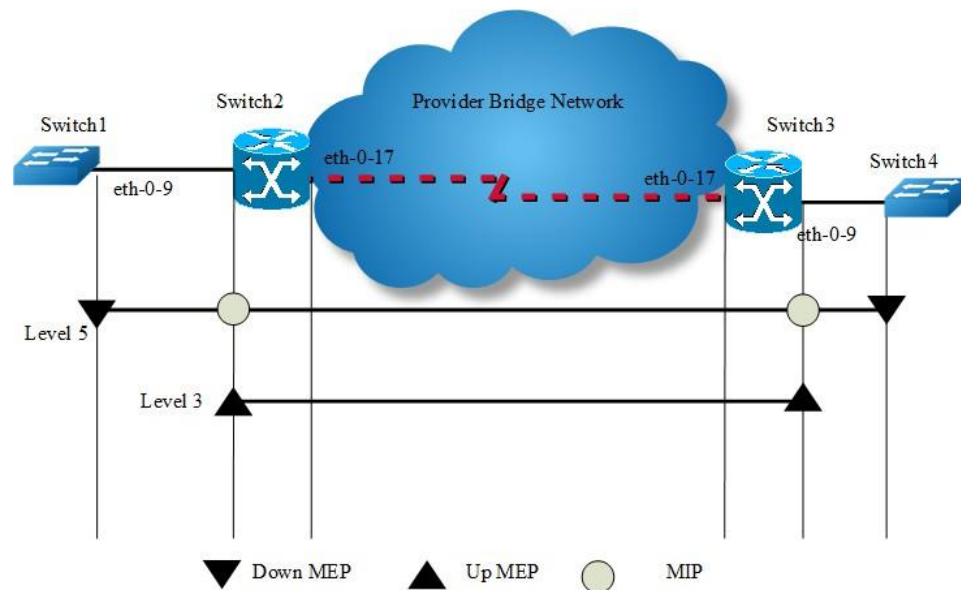

Figure 16-9 CFM

step 1 Configuration prepare

Reference to the chapter "Configure CC/LB/LT/AIS/DM".

step 2 Configure Single-Ended LM

Configuring Switch1:

```
Switch(config)# ethernet cfm lm enable single-ended domain cust vlan 30 mepid 66
all-cos
```

Configuring Switch4:

```
Switch(config)# ethernet cfm lm enable single-ended domain cust vlan 30 mepid 99
all-cos
```

step 3 Validation

The following command is used to output lmm and display lm results for Switch1.

```
Switch# ethernet cfm lm single-ended domain cust vlan 30 rmepid 99 mepid 66 count
10
DOMAIN      : cust
VLAN        : 30
MEPID       : 66
Start Time  : 2013/07/16 1:39:38
End Time    : 2013/07/16 1:39:38
```

- Notes : 1. When the difference of Tx is less than the difference of Rx, the node is invalid, loss and loss ratio should be "-";
2. When loc is reported for mep, the loss should be "-" and loss ratio should be 100%;
3. When calculate average loss and loss ratio, invalid or loc nodes will be excluded;

Latest single-ended loss statistics:

Index	Cos	Local-loss	Local-loss ratio	Remote-loss	Remote-loss ratio
1	all	000.0000%	0	000.0000%	0
2	all	000.0000%	0	000.0000%	0
3	all	000.0000%	0	000.0000%	0
4	all	000.0000%	0	000.0000%	0
5	all	000.0000%	0	000.0000%	0
6	all	000.0000%	0	000.0000%	0
7	all	000.0000%	0	000.0000%	0
8	all	000.0000%	0	000.0000%	0
9	all	000.0000%	0	000.0000%	0

Maximum Local-loss : 0 Maximum Local-loss Ratio : 000.0000%

Minimum Local-loss : 0 Minimum Local-loss Ratio : 000.0000%

Average Local-loss : 0 Average Local-loss Ratio : 000.0000%

Maximum Remote-loss : 0 Maximum Remote-loss Ratio : 000.0000%

Minimum Remote-loss : 0 Minimum Remote-loss Ratio : 000.0000%

Average Remote-loss : 0 Average Remote-loss Ratio : 000.0000%

Configure Test

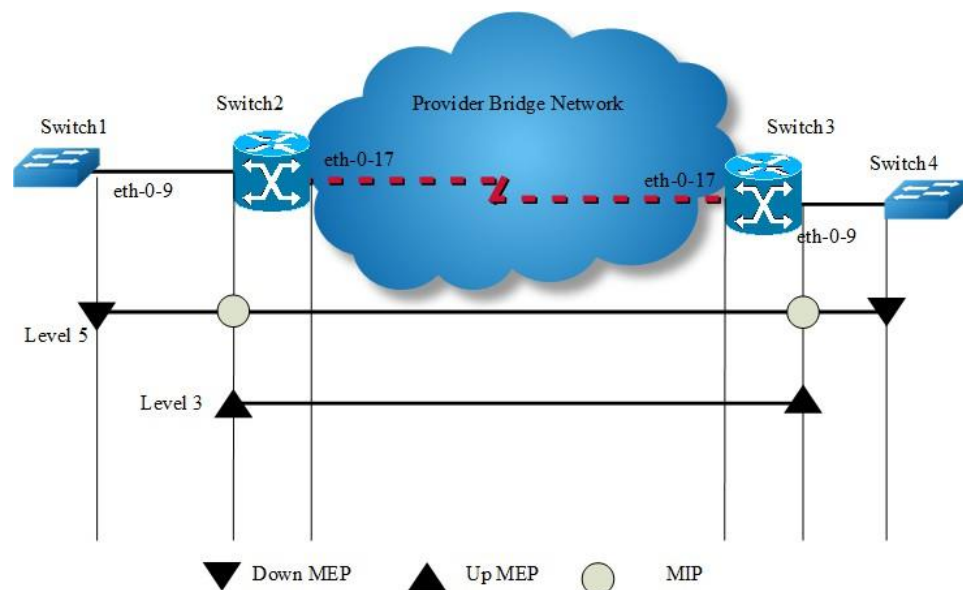

Figure 16-10 CFM

step 1 Configuration prepare

Reference to the chapter "Configure CC/LB/LT/AIS/DM".

step 2 Configure Test

Configure test transmission enable on Switch1:

```
Switch(config)# ethernet cfm tst transmission enable domain cust vlan 30 mep 66 tx-
mode continuous pattern-type random packet-size 6
```

Configure test reception enable on Switch4:

```
Switch(config)# ethernet cfm tst reception enable domain cust vlan 30 mep 99
```

step 3 Validation

The following command is used to start test transmission on Switch1.

```
Switch# ethernet cfm tst start rate 1000 time second 1
```

The following command is used to display test information on Switch1.

```
Switch# show ethernet cfm tst
DOMAIN          : cust
VLAN            : 30
MEPID           : 66
Transmission    : Enabled
Reception       : Disabled
Status          : Non-Running
Start Time      : 06:32:48
Predict End Time : 06:33:18
Actual End Time : 06:33:18
Packet Type     : TST
Rate            : 1000 mbps
Packet Size     : 64 bytes
Tx Number       : 29
Tx Bytes        : 1856
Rx Number       : 0
Rx Bytes        : 0
```

The following command is used to display test information on Switch4.

```
Switch# show ethernet cfm tst
DOMAIN          : cust
VLAN            : 30
MEPID           : 99
Transmission    : Disabled
Reception       : Enabled
Status          : Non-Running
Start Time      : null
End Time        : null
```

```

Packet Type      : null
Rate            : null
Packet Size     : null
Tx Number       : 0
Tx Bytes        : 0
Rx Number       : 29
Rx Bytes        : 1856

```

16.3.3 Application cases

N/A

16.4 Configuring CPU Traffic

16.4.1 Overview

Function Introduction

CPU traffic limit is a useful mechanism for protecting CPU from malicious flows by injecting huge volume of PDUs into switches.

CPU traffic limit provides two-level protection for CPU.

- The low-level traffic limit is performed for each reason, which is realized by queue shaping of each type of PDU.
- The high-level traffic limit is performed for all reasons, which is realized by channel shaping at CPU channel.

With this two-level protection, each PDU-to-CPU rate is limited and the overall PDU-to-CPU rate is also limited.



NOTE : The word “reason”, means this type of packets will be sent to cpu for further processing.

The description of all reason is as following.

Reason	Description
arp	Address Resolution Protocol
bpdu	Bridge Protocol Data Unit

dhcp	Dynamic Host Configuration Protocol
eapol	Extensible Authentication Protocol Over Lan
erps	Ethernet Ring Protection Switching
fwd-to-cpu	Packets forwarding to cpu
icmp-redirect	ICMP Redirect
igmp	IGMP Snooping Protocol
ip-option	Packets with IP Option
ipda	IP Destination to Router-self
ssh	SSH protocol packet
telnet	Telnet protocol packet
mlag	MLAG protocol packet
tcp	TCP protocol packet
ldp	Label Distribution Protocol
macsa-mismatch	Port Security for source mac learned
mcast-rpf-fail	Multicast with rpf fail or first multicast packet
mpls-ttl-fail	Mpls Packets with ttl fail
ip-mtu-fail	IP packet with mtu fail
ospf	Open Shortest Path First
pim	Protocol Independent Multicast
port-security-discard	Port Security for exceeding fdb maxnum
rip	Routing Information Protocol
sflow-egress	Sampled flow at egress direction
sflow-ingress	Sampled flow at ingress direction

slow-protocol	Slow Protocol (including EFM, LACP and SYNCE)
smart-link	Smart Link Protocol
ucast-ttl-fail	Unicast Packets with ttl fail
udld	Unidirectional Link Detection Protocol
vlan-security-discard	Vlan Security for exceeding fdb maxnum
vrrp	Virtual Router Redundancy Protocol
bfd-learning	BFD learning packets
dot1x-mac-bypass	Mac auth bypass packets
bgp	Border gateway protocol packet
egress-ttl-fail	Egress ttl fail packet
icmpv6	ICMPv6 packet
l2protocol-tunnel	Layer2 protocol tunnel packet
loopback-detection	Loopback detection packet
mirror-to-cpu	Mirror to cpu packet
ndp	Neighbor discovery protocol packet
tunnel-gre-keepalive	Tunnel gre keepalive reply packet

The default rate and class configuration for all reason is as following.

reason	rate(pps)	class
arp	256	1
bpdu	64	3
dhcp	128	0
eapol	128	0
erps	128	3

fwd-to-cpu	64	0
icmp-redirect	128	0
igmp	128	2
ip-option	512	0
ipda	1000	0
ssh	64	3
telnet	64	3
mlag	1000	1
tcp	64	2
ldp	512	1
macsa-mismatch	128	0
mcast-rpf-fail	128	1
mpls-ttl-fail	64	0
ip-mtu-fail	64	0
ospf	256	1
pim	128	1
port-security-discard	128	0
rip	64	1
sflow-egress	128	0
sflow-ingress	128	0
slow-protocol	256	1
smart-link	128	2
ucast-ttl-fail	64	0
udld	128	3

vlan-security-discard	128	0
vrrp	512	1
bfd-learning	128	1
dot1x-mac-bypass	64	2
bgp	256	1
egress-ttl-fail	64	0
icmpv6	64	2
l2protocol-tunnel	1000	0
loopback-detection	64	3
mirror-to-cpu	1000	0
ndp	64	2
tunnel-gre-keepalive	64	0

Principle Description

Terminology

- PDU: Protocol Data Unit

16.4.2 Configuration

step 1 Enter the configure mode

```
Switch# configure terminal
```

step 2 Set the total rate

The default value of total rate is 2000, the unit is pps (packet-per-second)

```
Switch(config)# cpu-traffic-limit total rate 3000
```

step 3 Set the separate rate

Use RIP packets for example:

```
Switch(config)# cpu-traffic-limit reason rip rate 500
```

step 4 Set the reason class

```
Switch(config)# cpu-traffic-limit reason rip class 3
```



NOTE

The valid range of reason class is 0-3. The larger number indicates the higher priority.

step 5 Exit the configure mode

```
Switch(config)# end
```

step 6 Validation

To display the CPU Traffic Limit configuration, use following privileged EXEC commands.

```
Switch# show cpu traffic-limit
reason                rate (pps)  class
dot1x-mac-bypass      64          2
bpd                    64          3
slow-protocol         256         1
eapol                 128         0
erps                  128         3
smart-link            128         2
udld                   128         3
loopback-detection    64          3
arp                   256         1
dhcp                  128         0
rip                   500         3
ldp                   512         1
ospf                  256         1
pim                   128         1
bgp                   256         1
vrrp                  512         1
ndp                   64          2
icmpv6                64          2
ssh                   64          3
telnet                64          3
mlag                  1000        1
tcp                   64          2
ipda                  1000        0
icmp-redirect         128         0
mcast-rpf-fail        128         1
macsa-mismatch        128         0
port-security-discard 128         0
vlan-security-discard 128         0
egress-ttl-fail       64          0
ip-mtu-fail           64          0
```

```

bfd-learning          128          1
ptp                   512          2
ip-option             512          0
tunnel-gre-keepalive 64           0
ucast-ttl-fail       64           0
mpls-ttl-fail        64           0
igmp                  128          2
sflow-ingress        128          0
sflow-egress         128          0
fwd-to-cpu           64           0
l2protocol-tunnel    1000         0
mirror-to-cpu        1000         0
Total rate:          3000 (pps)

```

To display the CPU Traffic statistics information, use following privileged EXEC commands.

```

Switch# show cpu traffic-statistics receive all
statistics rate time is 5 second(s)
reason          count (packets)  rate(pps)
dot1x-mac-bypass 0                 0
bpdud           0                 0
slow-protocol    0                 0
eapol            0                 0
erps             0                 0
smart-link       0                 0
udld             0                 0
loopback-detection 0                 0
arp              0                 0
dhcp             0                 0
rip              0                 0
ldp              0                 0
ospf             0                 0
pim              0                 0
bgp              0                 0
vrrp            0                 0
rsvp            0                 0
ndp             0                 0
icmpv6          0                 0
ssh             0                 0
telnet          0                 0
mlag            0                 0
tcp             0                 0
ipda            0                 0
icmp-redirect    0                 0
mcast-rpf-fail  0                 0
macsa-mismatch  0                 0
port-security-discard 0                 0
vlan-security-discard 0                 0
egress-ttl-fail 0                 0
ip-mtu-fail     0                 0
bfd-learning     0                 0
ptp              0                 0
ip-option        0                 0
tunnel-gre-keepalive 0                 0

```

ucast-ttl-fail	0	0
mpls-ttl-fail	0	0
igmp	0	0
sflow-ingress	0	0
sflow-egress	0	0
fwd-to-cpu	0	0
l2protocol-tunnel	0	0
mirror-to-cpu	0	0
mpls-tp-pwoam	0	0
other	0	0
Total	0	0

16.4.3 Application cases

N/A

16.5 Configuring G.8031

16.5.1 Overview

Function Introduction

This document describes the configuration of G.8031 Ethernet Linear Protection Switching.

The goal of linear protection switching mechanism is to satisfy the requirement of fast protection switching for ethernet network. Linear protection switching means that, for one or more working transport entities, there is one protection transport entity, which is disjoint from any of working transport entities, ready for taking over the service transmission when a working transport entity failed.

To guarantee the protection switching time, for a working transport entity, its protection transport entity is always pre-configured before the failure occurs. Normally, the normal traffic will be transmitted and received on the working transport entity. The switching to protection transport entity is usually triggered by link/node failure, external commands, etc. Note that external commands are often used in transport network by operators, and they are very useful in cases of service adjustment, path maintenance, etc.

Principle Description

Reference: ITU-T G.8031/Y.1342 (06/2006)

16.5.2 Configuration

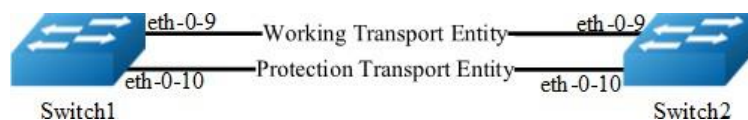

Figure 16-11 G.8031

The following configuration should be operated on all switches if the switch ID is not specified.

step 1 Enter the configure mode

```
Switch# configure terminal
```

step 2 Enter the vlan configure mode and create the vlan

```
Switch(config)# vlan database
Switch(config-vlan)# vlan 10-20
Switch(config-vlan)# exit
```

step 3 Set the spanning tree mode and create mstp instance

```
Switch(config)# spanning-tree mode mstp
Switch(config)# spanning-tree mst configuration
Switch(config-mst)# instance 10 vlan 10-20
Switch(config-mst)# exit
```

step 4 Enable cfm globally, create cfm domain and bind the vlan, enable continuity check

```
Switch1(config)# ethernet cfm enable
Switch1(config)# ethernet cfm domain test level 5
Switch1(config-ether-cfm)# service test1 vlan 10
Switch1(config-ether-cfm)# service test2 vlan 11
Switch1(config-ether-cfm)# exit
Switch1(config)# ethernet cfm cc enable domain test vlan 10
Switch1(config)# ethernet cfm cc enable domain test vlan 11
```

step 5 Enter the interface configure mode and set the attributes of the interface

Interface configuration for Switch1:

```
Switch(config)# interface eth-0-9
Switch(config-if)# switchport mode trunk
Switch(config-if)# switchport trunk allowed vlan add 10-20
```

```
Switch(config-if)# ethernet cfm mep down mpid 10 domain test vlan 10 interval 1
Switch(config-if)# ethernet cfm mep crosscheck mpid 12 domain test vlan 10 mac
bab3.08a4.c709
Switch(config-if)# spanning-tree port disable
Switch(config-if)# no shutdown
Switch(config-if)# exit

Switch(config)# interface eth-0-10
Switch(config-if)# switchport mode trunk
Switch(config-if)# switchport trunk allowed vlan add 10-20
Switch(config-if)# ethernet cfm mep down mpid 11 domain test vlan 11 interval 1
Switch(config-if)# ethernet cfm mep crosscheck mpid 13 domain test vlan 11 mac
bab3.08a4.c70a
Switch(config-if)# spanning-tree port disable
Switch(config-if)# no shutdown
Switch(config-if)# exit
```

Interface configuration for Switch2:

```
Switch(config)# interface eth-0-9
Switch(config-if)# switchport mode trunk
Switch(config-if)# switchport trunk allowed vlan add 10-20
Switch(config-if)# ethernet cfm mep down mpid 12 domain test vlan 10 interval 1
Switch(config-if)# ethernet cfm mep crosscheck mpid 10 domain test vlan 10 mac
bab3.08a4.c809
Switch(config-if)# spanning-tree port disable
Switch(config-if)# exit

Switch(config)# interface eth-0-10
Switch(config-if)# switchport mode trunk
Switch(config-if)# switchport trunk allowed vlan add 10-20
Switch(config-if)# ethernet cfm mep down mpid 13 domain test vlan 11 interval 1
Switch(config-if)# ethernet cfm mep crosscheck mpid 11 domain test vlan 11 mac
bab3.08a4.c80a
Switch(config-if)# spanning-tree port disable
Switch(config-if)# exit
```

step 6 Create G8031 group and bind the mstp instance

```
Switch(config)# g8031 eps-id 10 working-port eth-0-9 protection-port eth-0-10
Switch(g8031-config-switching)# domain test working-service test1 protection-
service test2
Switch(g8031-config-switching)# instance 10
Switch(config-if)# exit
```

step 7 Exit the configure mode

```
Switch(config)# end
```

step 8 Validation

Display the result on Switch1.

```
Switch# show g8031
Codes: ID - Group id of G.8031
       IF-W - Interface of working entity, IF-P - Interface of protection entity
       MD - Maintenance domain
       MA-W - Maintenance association of working entity
       MA-P - Maintenance association of protection entity
       CS - Current state, LS - Last state, LE - Last event, FS - Far end state
       R/B - Request signal & bridged signal, MODE - Revertive or Non-revertive
       WTR - Wait to restore, DFOP - Failure of protocol defects
=====
ID    IF-W    IF-P    MD    MA-W  MA-P  CS    LS    LE    FS    R/B    MODE
-----
10   eth-0-9 eth-0-10 test  test1 test2 NR    NR    NR    NR    NR    null  REV
APS Vid - 11
Active-Path - Working
DFOP State - Not in defect mode
Protected Instance - 10
=====
```

Display the result on Switch2.

```
Switch# show g8031
Codes: ID - Group id of G.8031
       IF-W - Interface of working entity, IF-P - Interface of protection entity
       MD - Maintenance domain
       MA-W - Maintenance association of working entity
       MA-P - Maintenance association of protection entity
       CS - Current state, LS - Last state, LE - Last event, FS - Far end state
       R/B - Request signal & bridged signal, MODE - Revertive or Non-revertive
       WTR - Wait to restore, DFOP - Failure of protocol defects
=====
ID    IF-W    IF-P    MD    MA-W  MA-P  CS    LS    LE    FS    R/B    MODE
-----
10   eth-0-9 eth-0-10 test  test1 test2 NR    NR    NR    NR    NR    null  REV
APS Vid - 11
Active-Path - Working
DFOP State - Not in defect mode
Protected Instance - 10
=====
```

16.5.3 Application cases

N/A

16.6 Configuring G8032

16.6.1 Overview

Ethernet rings can provide wide-area multipoint connectivity more economically due to their reduced number of links. Each ring node is connected to adjacent nodes participating in the same ring, using two independent links. A ring link is bounded by

two adjacent nodes and a port for a ring link is called a ring port. The minimum number of nodes on a ring is two.

The fundamentals of this ring protection switching architecture are:

The principle of loop avoidance

The utilization of learning, forwarding, and address table mechanisms defined in the Ethernet flow forwarding function (ETH_FF).

Loop avoidance in the ring is achieved by guaranteeing that, at any time, traffic may flow on all but one of the ring links. This particular link is called the ring protection link (RPL), and under normal conditions this link is blocked, i.e., not used for traffic. One designated node, the RPL owner, is responsible to block traffic over the RPL. Under a ring failure condition, the RPL owner is responsible to unblock the RPL, allowing the RPL to be used for traffic.

The event of a ring failure results in protection switching of the traffic. This is achieved under the control of the ETH_FF functions on all ring nodes.

An APS protocol is used to coordinate the protection actions over the ring.

Function Introduction

N/A

Principle Description

- Reference:
- T-REC-G.8032-200806-1!!PDF-E.pdf
- T-REC-G.8032-201003-1!!PDF-E.pdf
- T-REC-G.8032-201708-1!Cor1!PDF-E.pdf

16.6.2 Topology

- Topology of single ring

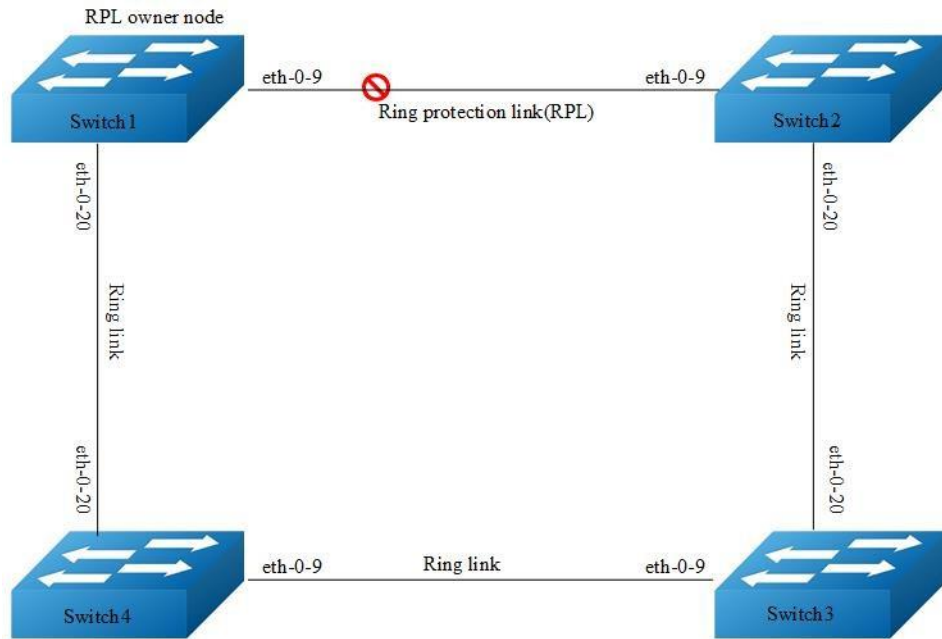

Figure 16-12 Topology of single G8032 ring

➤ Topology of multiple rings

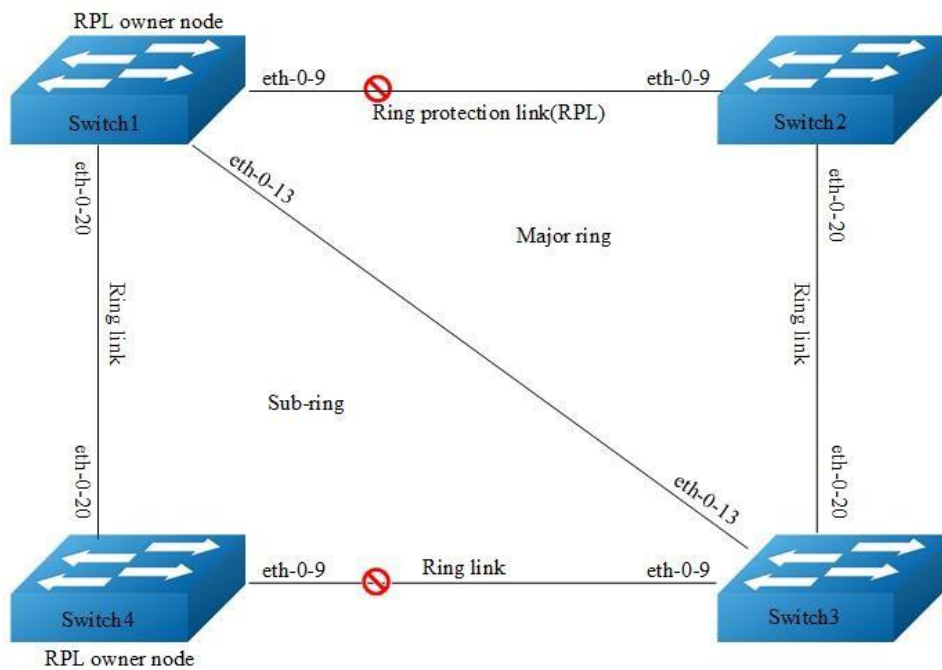

Figure 16-13 Topology of multiple G8032 rings

16.6.3 Configuration of single ring

step 1 Configuration of Switch1

```
Switch# configure terminal
Enter configuration commands, one per line. End with CNTL/Z.
Switch(config)# vlan database
Switch(config-vlan)# vlan 10-100
Switch(config-vlan)# exit
Switch(config)# spanning-tree mode mstp
Switch(config)# spanning-tree mst configuration
Switch(config-mst)# instance 1 vlan 10-99
Switch(config-mst)# exit
Switch(config)# no ip igmp snooping vlan 100
Switch(config)# interface eth-0-9
Switch(config-if)# switchport mode trunk
Switch(config-if)# switchport trunk allowed vlan add 10-100
Switch(config-if)# spanning-tree port disable
Switch(config-if)# no shutdown
Switch(config-if)# exit
Switch(config)# interface eth-0-20
Switch(config-if)# switchport mode trunk
Switch(config-if)# switchport trunk allowed vlan add 10-100
Switch(config-if)# spanning-tree port disable
Switch(config-if)# no shutdown
Switch(config-if)# exit
Switch(config)# g8032 ring-id 1 east-interface eth-0-9 west-interface eth-0-20
Switch(g8032-config-switch)# rpl owner east-interface
Switch(g8032-config-switch)# instance 1
Switch(g8032-config-switch)# control-vlan 100
Switch(g8032-config-switch)# ring enable
```

step 2 Switch1 validation

```
Switch# show g8032
RingID MajorRing State East Status West Status
-----
1 N/A Pending eth-0-9 Blocked eth-0-20 Forward

Control Vlan : 100
Is Enabled : Yes
Mode : Revertive
Node Role : Owner
Is Sub_ring : No
Protect Instance : 1
RPL : east-interface
Wait-to-restore : 04:26 (266492 msecs)
Hold-off Timer : 0 (msecs)
Guard Timer : 500 (msecs)
WTB Timer : 5500 (msecs)
RAPS MEL : 7
```

```
Is Forward-to-cpu      : 1
-----
```

step 3 Configuration of Switch2

```
Switch# configure terminal
Enter configuration commands, one per line. End with CNTL/Z.
Switch(config)# vlan database
Switch(config-vlan)# vlan 10-100
Switch(config-vlan)# exit
Switch(config)# spanning-tree mode mstp
Switch(config)# spanning-tree mst configuration
Switch(config-mst)# instance 1 vlan 10-99
Switch(config-mst)# exit
Switch(config)# no ip igmp snooping vlan 100
Switch(config)# interface eth-0-9
Switch(config-if)# switchport mode trunk
Switch(config-if)# switchport trunk allowed vlan add 10-100
Switch(config-if)# spanning-tree port disable
Switch(config-if)# no shutdown
Switch(config-if)# exit
Switch(config)# interface eth-0-20
Switch(config-if)# switchport mode trunk
Switch(config-if)# switchport trunk allowed vlan add 10-100
Switch(config-if)# spanning-tree port disable
Switch(config-if)# no shutdown
Switch(config-if)# exit
Switch(config)# g8032 ring-id 1 east-interface eth-0-9 west-interface eth-0-20
Switch(g8032-config-switch)# instance 1
Switch(g8032-config-switch)# control-vlan 100
Switch(g8032-config-switch)# ring enable
```

step 4 Switch2 validation

```
Switch# show g8032
RingID MajorRing State East Status West Status
-----
1 N/A Pending eth-0-9 Blocked eth-0-20 Forward

Control Vlan : 100
Is Enabled : Yes
Mode : Revertive
Node Role : N/A
Is Sub_ring : No
Protect Instance : 1
Wait-to-restore : 05:00
Hold-off Timer : 0 (msecs)
Guard Timer : 500 (msecs)
WTB Timer : 5500 (msecs)
RAPS MEL : 7
Is Forward-to-cpu : 1
-----
```

step 5 Configuration of Switch3

```
Switch# configure terminal
Enter configuration commands, one per line. End with CNTL/Z.
Switch(config)# vlan database
Switch(config-vlan)# vlan 10-100
Switch(config-vlan)# exit
Switch(config)# spanning-tree mode mstp
Switch(config)# spanning-tree mst configuration
Switch(config-mst)# instance 1 vlan 10-99
Switch(config-mst)# exit
Switch(config)# no ip igmp snooping vlan 100
Switch(config)# interface eth-0-9
Switch(config-if)# switchport mode trunk
Switch(config-if)# switchport trunk allowed vlan add 10-100
Switch(config-if)# spanning-tree port disable
Switch(config-if)# no shutdown
Switch(config-if)# exit
Switch(config)# interface eth-0-20
Switch(config-if)# switchport mode trunk
Switch(config-if)# switchport trunk allowed vlan add 10-100
Switch(config-if)# spanning-tree port disable
Switch(config-if)# no shutdown
Switch(config-if)# exit
Switch(config)# g8032 ring-id 1 east-interface eth-0-9 west-interface eth-0-20
Switch(g8032-config-switch)# instance 1
Switch(g8032-config-switch)# control-vlan 100
Switch(g8032-config-switch)# ring enable
```

step 6 Switch3 validation

```
Switch# show g8032
```

RingID	MajorRing	State	East	Status	West	Status
1	N/A	Pending	eth-0-9	Blocked	eth-0-20	Forward

```
Control Vlan          : 100
Is Enabled            : Yes
Mode                  : Revertive
Node Role             : N/A
Is Sub_ring          : No
Protect Instance     : 1
Wait-to-restore      : 05:00
Hold-off Timer       : 0 (msecs)
Guard Timer          : 500 (msecs)
WTB Timer            : 5500 (msecs)
RAPS MEL             : 7
Is Forward-to-cpu   : 1
```

step 7 Configuration of Switch4

```
Switch# configure terminal
Enter configuration commands, one per line. End with CNTL/Z.
Switch(config)# vlan database
Switch(config-vlan)# vlan 10-100
Switch(config-vlan)# exit
Switch(config)# spanning-tree mode mstp
Switch(config)# spanning-tree mst configuration
Switch(config-mst)# instance 1 vlan 10-99
Switch(config-mst)# exit
Switch(config)# no ip igmp snooping vlan 100
Switch(config)# interface eth-0-9
Switch(config-if)# switchport mode trunk
Switch(config-if)# switchport trunk allowed vlan add 10-100
Switch(config-if)# spanning-tree port disable
Switch(config-if)# no shutdown
Switch(config-if)# exit
Switch(config)# interface eth-0-20
Switch(config-if)# switchport mode trunk
Switch(config-if)# switchport trunk allowed vlan add 10-100
Switch(config-if)# spanning-tree port disable
Switch(config-if)# no shutdown
Switch(config-if)# exit
Switch(config)# g8032 ring-id 1 east-interface eth-0-9 west-interface eth-0-20
Switch(g8032-config-switch)# instance 1
Switch(g8032-config-switch)# control-vlan 100
Switch(g8032-config-switch)# ring enable
```

step Switch4 validation

```
Switch# show g8032
```

RingID	MajorRing	State	East	Status	West	Status
1	N/A	Pending	eth-0-9	Blocked	eth-0-20	Forward

```
Control Vlan           : 100
Is Enabled             : Yes
Mode                   : Revertive
Node Role              : N/A
Is Sub_ring           : No
Protect Instance      : 1
Wait-to-restore       : 05:00
Hold-off Timer        : 0 (msecs)
Guard Timer           : 500 (msecs)
WTB Timer              : 5500 (msecs)
RAPS MEL              : 7
Is Forward-to-cpu     : 1
```

16.6.4 Configuration of multiple rings - Non-virtual-channel

step 1 Configuration of Switch1

```
Switch# configure terminal
Enter configuration commands, one per line. End with CNTL/Z.
Switch(config)# vlan database
Switch(config-vlan)# vlan 10-150
Switch(config-vlan)# exit
Switch(config)# spanning-tree mode mstp
Switch(config)# spanning-tree mst configuration
Switch(config-mst)# instance 1 vlan 10-99
Switch(config-mst)# instance 2 vlan 101-150
Switch(config-mst)# exit
Switch(config)# no ip igmp snooping vlan 100
Switch(config)# no ip igmp snooping vlan 20
Switch(config)# interface eth-0-9
Switch(config-if)# switchport mode trunk
Switch(config-if)# switchport trunk allowed vlan add 10-150
Switch(config-if)# spanning-tree port disable
Switch(config-if)# no shutdown
Switch(config-if)# exit
Switch(config)# interface eth-0-13
Switch(config-if)# switchport mode trunk
Switch(config-if)# switchport trunk allowed vlan add 10-150
Switch(config-if)# spanning-tree port disable
Switch(config-if)# no shutdown
Switch(config-if)# exit
Switch(config)# interface eth-0-20
Switch(config-if)# switchport mode trunk
Switch(config-if)# switchport trunk allowed vlan add 101-150
Switch(config-if)# switchport trunk allowed vlan add 20
Switch(config-if)# spanning-tree port disable
Switch(config-if)# no shutdown
Switch(config-if)# exit
Switch(config)# g8032 ring-id 1 east-interface eth-0-9 west-interface eth-0-13
Switch(g8032-config-switch)# rpl owner east-interface
Switch(g8032-config-switch)# instance 1
Switch(g8032-config-switch)# instance 2
Switch(g8032-config-switch)# control-vlan 100
Switch(g8032-config-switch)# ring enable
Switch(g8032-config-switch)# exit
Switch(config)# g8032 ring-id 2 interface eth-0-20 major-ring-id 1
Switch(g8032-config-switch)# instance 2
Switch(g8032-config-switch)# control-vlan 20
Switch(g8032-config-switch)# ring enable
```

step 2 Switch1 validation

```
Switch# show g8032
RingID MajorRing State East Status West Status
-----
```

1	N/A	Pending	eth-0-9	Blocked	eth-0-13	Forward
Control Vlan		:	100			
Is Enabled		:	Yes			
Mode		:	Revertive			
Node Role		:	Owner			
Is Sub_ring		:	No			
Protect Instance		:	1-2			
Sub-ring		:	2			
RPL		:	east-interface			
Wait-to-restore		:	04:26 (266492 msecs)			
Hold-off Timer		:	0 (msecs)			
Guard Timer		:	500 (msecs)			
WTB Timer		:	5500 (msecs)			
RAPS MEL		:	7			
Is Forward-to-cpu		:	1			

RingID	MajorRing	State	East	Status	West	Status

2	1	Pending	eth-0-20	Blocked	N/A	N/A
Control Vlan		:	20			
Is Enabled		:	No			
Mode		:	Revertive			
Node Role		:	N/A			
Is Sub_ring		:	Yes			
Virtual-channel		:	Disable			
Protect Instance		:	2			
Wait-to-restore		:	05:00			
Hold-off Timer		:	0 (msecs)			
Guard Timer		:	500 (msecs)			
WTB Timer		:	5500 (msecs)			
RAPS MEL		:	7			
Is Forward-to-cpu		:	1			

step 3 Configuration of Switch2

```
Switch# configure terminal
Enter configuration commands, one per line. End with CNTL/Z.
Switch(config)# vlan database
Switch(config-vlan)# vlan 10-150
Switch(config-vlan)# exit
Switch(config)# spanning-tree mode mstp
Switch(config)# spanning-tree mst configuration
Switch(config-mst)# instance 1 vlan 10-99
Switch(config-mst)# instance 2 vlan 101-150
Switch(config-mst)# exit
Switch(config)# no ip igmp snooping vlan 100
Switch(config)# interface eth-0-9
Switch(config-if)# switchport mode trunk
Switch(config-if)# switchport trunk allowed vlan add 10-150
Switch(config-if)# spanning-tree port disable
Switch(config-if)# no shutdown
```

```

Switch(config-if)# exit
Switch(config)# interface eth-0-20
Switch(config-if)# switchport mode trunk
Switch(config-if)# switchport trunk allowed vlan add 10-150
Switch(config-if)# spanning-tree port disable
Switch(config-if)# no shutdown
Switch(config-if)# exit
Switch(config)# g8032 ring-id 1 east-interface eth-0-9 west-interface eth-0-20
Switch(g8032-config-switch)# instance 1
Switch(g8032-config-switch)# instance 2
Switch(g8032-config-switch)# control-vlan 100
Switch(g8032-config-switch)# ring enable

```

step 4 Switch2 validation

```

Switch# show g8032

```

RingID	MajorRing	State	East	Status	West	Status
1	N/A	Pending	eth-0-9	Blocked	eth-0-20	Forward

```

Control Vlan          : 100
Is Enabled            : Yes
Mode                  : Revertive
Node Role             : N/A
Is Sub_ring          : No
Protect Instance     : 1-2
Wait-to-restore      : 05:00
Hold-off Timer       : 0 (msecs)
Guard Timer          : 500 (msecs)
WTB Timer            : 5500 (msecs)
RAPS MEL             : 7
Is Forward-to-cpu   : 0

```

step 5 Configuration of Switch3

```

Switch# configure terminal
Enter configuration commands, one per line. End with CNTL/Z.
Switch(config)# vlan database
Switch(config-vlan)# vlan 10-150
Switch(config-vlan)# exit
Switch(config)# spanning-tree mode mstp
Switch(config)# spanning-tree mst configuration
Switch(config-mst)# instance 1 vlan 10-99
Switch(config-mst)# instance 2 vlan 101-150
Switch(config-mst)# exit
Switch(config)# no ip igmp snooping vlan 100
Switch(config)# no ip igmp snooping vlan 20
Switch(config)# interface eth-0-9
Switch(config-if)# switchport mode trunk
Switch(config-if)# switchport trunk allowed vlan add 101-150
Switch(config-if)# switchport trunk allowed vlan add 20
Switch(config-if)# spanning-tree port disable
Switch(config-if)# no shutdown

```

```

Switch(config-if)# exit
Switch(config)# interface eth-0-13
Switch(config-if)# switchport mode trunk
Switch(config-if)# switchport trunk allowed vlan add 10-150
Switch(config-if)# spanning-tree port disable
Switch(config-if)# no shutdown
Switch(config-if)# exit
Switch(config)# interface eth-0-20
Switch(config-if-eth-0-20)# switchport mode trunk
Switch(config-if-eth-0-20)# switchport trunk allowed vlan add 10-150
Switch(config-if-eth-0-20)# spanning-tree port disable
Switch(config-if-eth-0-20)# no shutdown
Switch(config-if-eth-0-20)# exit
Switch(config)# g8032 ring-id 1 east-interface eth-0-13 west-interface eth-0-20
Switch(g8032-config-switch)# rpl owner east-interface
Switch(g8032-config-switch)# instance 1
Switch(g8032-config-switch)# instance 2
Switch(g8032-config-switch)# control-vlan 100
Switch(g8032-config-switch)# ring enable
Switch(g8032-config-switch)# exit
Switch(config)# g8032 ring-id 2 interface eth-0-9 major-ring-id 1
Switch(g8032-config-switch)# instance 2
Switch(g8032-config-switch)# control-vlan 20
Switch(g8032-config-switch)# ring enable

```

step 6 Switch3 validation

```

Switch# show g8032

```

RingID	MajorRing	State	East	Status	West	Status
1	N/A	Pending	eth-0-13	Blocked	eth-0-20	Forward

```

Control Vlan          : 100
Is Enabled            : Yes
Mode                  : Revertive
Node Role             : N/A
Is Sub_ring           : No
Protect Instance     : 1-2
Sub-ring              : 2
Wait-to-restore      : 05:00
Hold-off Timer        : 0 (msecs)
Guard Timer          : 500 (msecs)
WTB Timer             : 5500 (msecs)
RAPS MEL              : 7
Is Forward-to-cpu    : 0

```

RingID	MajorRing	State	East	Status	West	Status
2	1	Pending	eth-0-9	Blocked	N/A	N/A

```

Control Vlan          : 20
Is Enabled            : No
Mode                  : Revertive
Node Role             : N/A

```

```

Is Sub_ring           : Yes
Virtual-channel       : Disable
Protect Instance      : 2
Wait-to-restore       : 05:00
Hold-off Timer        : 0 (msecs)
Guard Timer           : 500 (msecs)
WTB Timer             : 5500 (msecs)
RAPS MEL              : 7
Is Forward-to-cpu     : 1

```

step 7 Configuration of Switch4

```

Switch# configure terminal
Enter configuration commands, one per line. End with CNTL/Z.
Switch# configure terminal
Enter configuration commands, one per line. End with CNTL/Z.
Switch(config)# vlan database
Switch(config-vlan)# vlan 101-150
Switch(config-vlan)# exit
Switch(config)# spanning-tree mode mstp
Switch(config)# spanning-tree mst configuration
Switch(config-mst)# instance 2 vlan 101-150
Switch(config-mst)# exit
Switch(config)# no ip igmp snooping vlan 20
Switch(config)# interface eth-0-9
Switch(config-if)# switchport mode trunk
Switch(config-if)# switchport trunk allowed vlan add 101-150
Switch(config-if)# spanning-tree port disable
Switch(config-if)# no shutdown
Switch(config-if)# exit
Switch(config)# interface eth-0-20
Switch(config-if)# switchport mode trunk
Switch(config-if)# switchport trunk allowed vlan add 101-150
Switch(config-if)# spanning-tree port disable
Switch(config-if)# no shutdown
Switch(config-if)# exit
Switch(config)# g8032 ring-id 2 east-interface eth-0-9 west-interface eth-0-20 is-
sub-ring
Switch(g8032-config-switch)# instance 2
Switch(g8032-config-switch)# rpl owner east-interface
Switch(g8032-config-switch)# control-vlan 20
Switch(g8032-config-switch)# ring enable

```

step Switch4 validation

```

Switch# show g8032

```

RingID	MajorRing	State	East	Status	West	Status
2	N/A	Pending	eth-0-9	Blocked	eth-0-20	Forward

```

Control Vlan           : 20
Is Enabled              : Yes
Mode                   : Revertive

```

```

Node Role           : Owner
Is Sub_ring         : Yes
Protect Instance    : 1-2
RPL                 : east-interface
Wait-to-restore     : 05:00
Hold-off Timer      : 0 (msecs)
Guard Timer         : 500 (msecs)
WTB Timer           : 5500 (msecs)
RAPS MEL            : 7
Is Forward-to-cpu   : 0
-----

```

16.6.5 Configuration of multiple rings - Virtual-channel

step 1 Configuration of Switch1

```

Switch# configure terminal
Enter configuration commands, one per line. End with CNTL/Z.
Switch(config)# vlan database
Switch(config-vlan)# vlan 10-150
Switch(config-vlan)# exit
Switch(config)# spanning-tree mode mstp
Switch(config)# spanning-tree mst configuration
Switch(config-mst)# instance 1 vlan 10-99
Switch(config-mst)# instance 2 vlan 101-150
Switch(config-mst)# exit
Switch(config)# no ip igmp snooping vlan 100
Switch(config)# no ip igmp snooping vlan 20
Switch(config)# interface eth-0-9
Switch(config-if)# switchport mode trunk
Switch(config-if)# switchport trunk allowed vlan add 10-150
Switch(config-if)# spanning-tree port disable
Switch(config-if)# no shutdown
Switch(config-if)# exit
Switch(config)# interface eth-0-13
Switch(config-if)# switchport mode trunk
Switch(config-if)# switchport trunk allowed vlan add 10-150
Switch(config-if)# spanning-tree port disable
Switch(config-if)# no shutdown
Switch(config-if)# exit
Switch(config)# interface eth-0-20
Switch(config-if)# switchport mode trunk
Switch(config-if)# switchport trunk allowed vlan add 101-150
Switch(config-if)# switchport trunk allowed vlan add 20
Switch(config-if)# spanning-tree port disable
Switch(config-if)# no shutdown
Switch(config-if)# exit
Switch(config)# g8032 ring-id 1 east-interface eth-0-9 west-interface eth-0-13
Switch(g8032-config-switch)# rpl owner east-interface
Switch(g8032-config-switch)# instance 1
Switch(g8032-config-switch)# instance 2
Switch(g8032-config-switch)# control-vlan 100
Switch(g8032-config-switch)# ring enable

```



```
Switch(g8032-config-switch)# exit
Switch(config)# g8032 ring-id 2 interface eth-0-20 major-ring-id 1
Switch(g8032-config-switch)# instance 2
Switch(g8032-config-switch)# control-vlan 20
Switch(g8032-config-switch)# virtual-channel enable
Switch(g8032-config-switch)# ring enable
```

step 2 Switch1 validation

```
Switch# show g8032
```

RingID	MajorRing	State	East	Status	West	Status
1	N/A	Pending	eth-0-9	Blocked	eth-0-13	Forward

```
Control Vlan          : 100
Is Enabled            : Yes
Mode                  : Revertive
Node Role             : Owner
Is Sub_ring           : No
Protect Instance      : 1-2
Sub-ring              : 2
RPL                   : east-interface
Wait-to-restore       : 04:26 (266492 msecs)
Hold-off Timer        : 0 (msecs)
Guard Timer          : 500 (msecs)
WTB Timer             : 5500 (msecs)
RAPS MEL              : 7
Is Forward-to-cpu    : 1
```

RingID	MajorRing	State	East	Status	West	Status
2	1	Pending	eth-0-20	Blocked	N/A	N/A

```
Control Vlan          : 20
Is Enabled            : No
Mode                  : Revertive
Node Role             : N/A
Is Sub_ring           : Yes
Virtual-channel       : Enable
Protect Instance      : 2
Wait-to-restore       : 05:00
Hold-off Timer        : 0 (msecs)
Guard Timer          : 500 (msecs)
WTB Timer             : 5500 (msecs)
RAPS MEL              : 7
Is Forward-to-cpu    : 0
```

step 3 Configuration of Switch2

```
Switch# configure terminal
Enter configuration commands, one per line. End with CNTL/Z.
Switch(config)# vlan database
```

```

Switch(config-vlan)# vlan 10-150
Switch(config-vlan)# exit
Switch(config)# spanning-tree mode mstp
Switch(config)# spanning-tree mst configuration
Switch(config-mst)# instance 1 vlan 10-99
Switch(config-mst)# instance 2 vlan 101-150
Switch(config-mst)# exit
Switch(config)# no ip igmp snooping vlan 100
Switch(config)# interface eth-0-9
Switch(config-if)# switchport mode trunk
Switch(config-if)# switchport trunk allowed vlan add 10-150
Switch(config-if)# spanning-tree port disable
Switch(config-if)# no shutdown
Switch(config-if)# exit
Switch(config)# interface eth-0-20
Switch(config-if)# switchport mode trunk
Switch(config-if)# switchport trunk allowed vlan add 10-150
Switch(config-if)# spanning-tree port disable
Switch(config-if)# no shutdown
Switch(config-if)# exit
Switch(config)# g8032 ring-id 1 east-interface eth-0-9 west-interface eth-0-20
Switch(g8032-config-switch)# instance 1
Switch(g8032-config-switch)# instance 2
Switch(g8032-config-switch)# control-vlan 100
Switch(g8032-config-switch)# ring enable

```

step 4 Switch2 validation

```

Switch# show g8032

```

RingID	MajorRing	State	East	Status	West	Status
1	N/A	Pending	eth-0-9	Blocked	eth-0-20	Forward

```

Control Vlan          : 100
Is Enabled            : Yes
Mode                  : Revertive
Node Role             : N/A
Is Sub_ring          : No
Protect Instance     : 1-2
Wait-to-restore      : 05:00
Hold-off Timer       : 0 (msecs)
Guard Timer          : 500 (msecs)
WTB Timer            : 5500 (msecs)
RAPS MEL             : 7
Is Forward-to-cpu   : 0

```

step 5 Configuration of Switch3

```

Switch# configure terminal
Enter configuration commands, one per line. End with CNTL/Z.
Switch(config)# vlan database
Switch(config-vlan)# vlan 10-150
Switch(config-vlan)# exit

```

```

Switch(config)# spanning-tree mode mstp
Switch(config)# spanning-tree mst configuration
Switch(config-mst)# instance 1 vlan 10-99
Switch(config-mst)# instance 2 vlan 101-150
Switch(config-mst)# exit
Switch(config)# no ip igmp snooping vlan 100
Switch(config)# no ip igmp snooping vlan 20
Switch(config)# interface eth-0-9
Switch(config-if)# switchport mode trunk
Switch(config-if)# switchport trunk allowed vlan add 101-150
Switch(config-if)# switchport trunk allowed vlan add 20
Switch(config-if)# spanning-tree port disable
Switch(config-if)# no shutdown
Switch(config-if)# exit
Switch(config)# interface eth-0-13
Switch(config-if)# switchport mode trunk
Switch(config-if)# switchport trunk allowed vlan add 10-150
Switch(config-if)# spanning-tree port disable
Switch(config-if)# no shutdown
Switch(config-if)# exit
Switch(config)# interface eth-0-20
Switch(config-if-eth-0-20)# switchport mode trunk
Switch(config-if-eth-0-20)# switchport trunk allowed vlan add 10-150
Switch(config-if-eth-0-20)# spanning-tree port disable
Switch(config-if-eth-0-20)# no shutdown
Switch(config-if-eth-0-20)# exit
Switch(config)# g8032 ring-id 1 east-interface eth-0-13 west-interface eth-0-20
Switch(g8032-config-switch)# rpl owner east-interface
Switch(g8032-config-switch)# instance 1
Switch(g8032-config-switch)# instance 2
Switch(g8032-config-switch)# control-vlan 100
Switch(g8032-config-switch)# ring enable
Switch(g8032-config-switch)# exit
Switch(config)# g8032 ring-id 2 interface eth-0-9 major-ring-id 1
Switch(g8032-config-switch)# instance 2
Switch(g8032-config-switch)# control-vlan 20
Switch(g8032-config-switch)# virtual-channel enable
Switch(g8032-config-switch)# ring enable

```

step 6 Switch3 validation

```

Switch# show g8032
RingID MajorRing State East Status West Status
-----
1 N/A Pending eth-0-13 Blocked eth-0-20 Forward

Control Vlan : 100
Is Enabled : Yes
Mode : Revertive
Node Role : N/A
Is Sub_ring : No
Protect Instance : 1-2
Sub-ring : 2
Wait-to-restore : 05:00
Hold-off Timer : 0 (msecs)

```

```
Guard Timer          : 500 (msecs)
WTB Timer            : 5500 (msecs)
RAPS MEL             : 7
Is Forward-to-cpu    : 0
```

RingID	MajorRing	State	East	Status	West	Status
2	1	Pending	eth-0-9	Blocked	N/A	N/A

```
Control Vlan        : 20
Is Enabled          : No
Mode                : Revertive
Node Role           : N/A
Is Sub_ring         : Yes
Virtual-channel     : Enable
Protect Instance    : 2
Wait-to-restore     : 05:00
Hold-off Timer      : 0 (msecs)
Guard Timer        : 500 (msecs)
WTB Timer           : 5500 (msecs)
RAPS MEL           : 7
Is Forward-to-cpu  : 0
```

step 7 Configuration of Switch4

```
Switch# configure terminal
Enter configuration commands, one per line. End with CNTL/Z.
Switch# configure terminal
Enter configuration commands, one per line. End with CNTL/Z.
Switch(config)# vlan database
Switch(config-vlan)# vlan 101-150
Switch(config-vlan)# exit
Switch(config)# spanning-tree mode mstp
Switch(config)# spanning-tree mst configuration
Switch(config-mst)# instance 2 vlan 101-150
Switch(config-mst)# exit
Switch(config)# no ip igmp snooping vlan 20
Switch(config)# interface eth-0-9
Switch(config-if)# switchport mode trunk
Switch(config-if)# switchport trunk allowed vlan add 101-150
Switch(config-if)# spanning-tree port disable
Switch(config-if)# no shutdown
Switch(config-if)# exit
Switch(config)# interface eth-0-20
Switch(config-if)# switchport mode trunk
Switch(config-if)# switchport trunk allowed vlan add 101-150
Switch(config-if)# spanning-tree port disable
Switch(config-if)# no shutdown
Switch(config-if)# exit
Switch(config)# g8032 ring-id 2 east-interface eth-0-9 west-interface eth-0-20 is-
sub-ring
Switch(g8032-config-switch)# instance 2
Switch(g8032-config-switch)# rpl owner east-interface
```

```
Switch(g8032-config-switch)# control-vlan 20
Switch(g8032-config-switch)# virtual-channel enable
Switch(g8032-config-switch)# ring enable
```

step Switch4 validation

```
Switch# show g8032
RingID MajorRing State East Status West Status
-----
2 N/A Pending eth-0-9 Blocked eth-0-20 Forward

Control Vlan : 20
Is Enabled : Yes
Mode : Revertive
Node Role : Owner
Is Sub_ring : Yes
Virtual-channel : Enable
Protect Instance : 1-2
RPL : east-interface
Wait-to-restore : 05:00
Hold-off Timer : 0 (msecs)
Guard Timer : 500 (msecs)
WTB Timer : 5500 (msecs)
RAPS MEL : 7
Is Forward-to-cpu : 0
```

16.6.6 Linkage between G8032 and CFM

There are two ways to trigger protection switch of G8032:

- Trigger by linkdown/shutdown state of interface
- Trigger by CFM

Configuration examples are as follows:

step 1 Configuration of Switch1

```
Switch# configure terminal
Enter configuration commands, one per line. End with CNTL/Z.
Switch(config)# vlan database
Switch(config-vlan)# vlan 10-100
Switch(config-vlan)# vlan 5
Switch(config-vlan)# exit
Switch(config)# spanning-tree mode mstp
Switch(config)# spanning-tree mst configuration
Switch(config-mst)# instance 1 vlan 10-99
Switch(config-mst)# exit
Switch(config)# no ip igmp snooping vlan 100
Switch(config)# ethernet cfm enable
Switch(config)# ethernet cfm domain mdl level 5
```

```

Switch(config-ether-cfm)# service mal vlan 5
Switch(config-ether-cfm)# exit
Switch(config)# ethernet cfm cc enable domain md1 vlan 5
Switch(config)# interface eth-0-9
Switch(config-if)# switchport mode trunk
Switch(config-if)# switchport trunk allowed vlan add 10-100
Switch(config-if)# spanning-tree port disable
Switch(config-if)# ethernet cfm mep down mpid 101 domain md1 vlan 5 interval 1
Switch(config-if)# ethernet cfm mep crosscheck mpid 201 domain md1 vlan 5 mac
e03e.b1e1.3309
Switch(config-if)# no shutdown
Switch(config-if)# exit
Switch(config)# interface eth-0-20
Switch(config-if)# switchport mode trunk
Switch(config-if)# switchport trunk allowed vlan add 10-100
Switch(config-if)# spanning-tree port disable
Switch(config-if)# ethernet cfm mep down mpid 102 domain md1 vlan 5 interval 1
Switch(config-if)# ethernet cfm mep crosscheck mpid 402 domain md1 vlan 5 mac
b2d0.60e4.c314
Switch(config-if)# no shutdown
Switch(config-if)# exit
Switch(config)# g8032 ring-id 1 east-interface eth-0-9 west-interface eth-0-20
Switch(g8032-config-switch)# rpl owner east-interface
Switch(g8032-config-switch)# instance 1
Switch(g8032-config-switch)# control-vlan 100
Switch(g8032-config-switch)# domain md1 service mal
Switch(g8032-config-switch)# ring enable

```

step 2 Switch1 validation

```

Switch# show g8032
RingID MajorRing State East Status West Status
-----
1 N/A Pending eth-0-9 Blocked eth-0-20 Forward

Control Vlan : 100
MD Name : md1
Service Id : mal
Is Enabled : Yes
Mode : Revertive
Node Role : Owner
Is Sub_ring : No
Protect Instance : 1
RPL : east-interface
Wait-to-restore : 04:26 (266492 msecs)
Hold-off Timer : 0 (msecs)
Guard Timer : 500 (msecs)
WTB Timer : 5500 (msecs)
RAPS MEL : 7
Is Forward-to-cpu : 1
-----

Switch# show ethernet cfm maintenance-points
#####Local MEP:
Dir-Direction;

```

```
L-Level;
```

MPID	Dir	DOMAIN	L	VLAN	PORT	CC-Status	MAC-Address	RDI	Interval
101	down	md1	5	5	eth-0-9	Enabled	104e.40d1.e309	False	3.3ms
102	down	md1	5	5	eth-0-20	Enabled	104e.40d1.e314	False	3.3ms

```
#####Remote MEP:
```

MPID	LEVEL	VLAN	Remote Mac	RDI	FLAGS	STATE
201	5	5	e03e.b1e1.3309	False	Mac_config	Up
402	5	5	b2d0.60e4.c314	False	Mac_config	Up

step 3 Configuration of Switch2

```
Switch# configure terminal
Enter configuration commands, one per line. End with CNTL/Z.
Switch(config)# vlan database
Switch(config-vlan)# vlan 10-100
Switch(config-vlan)# vlan 5
Switch(config-vlan)# exit
Switch(config)# spanning-tree mode mstp
Switch(config)# spanning-tree mst configuration
Switch(config-mst)# instance 1 vlan 10-99
Switch(config-mst)# exit
Switch(config)# no ip igmp snooping vlan 100
Switch(config)# ethernet cfm enable
Switch(config)# ethernet cfm domain md1 level 5
Switch(config-ether-cfm)# service mal vlan 5
Switch(config-ether-cfm)# exit
Switch(config)# ethernet cfm cc enable domain md1 vlan 5
Switch(config)# interface eth-0-9
Switch(config-if)# switchport mode trunk
Switch(config-if)# switchport trunk allowed vlan add 10-100
Switch(config-if)# spanning-tree port disable
Switch(config-if)# ethernet cfm mep down mpid 201 domain md1 vlan 5 interval 1
Switch(config-if)# ethernet cfm mep crosscheck mpid 101 domain md1 vlan 5 mac
104e.40d1.e309
Switch(config-if)# no shutdown
Switch(config-if)# exit
Switch(config)# interface eth-0-20
Switch(config-if)# switchport mode trunk
Switch(config-if)# switchport trunk allowed vlan add 10-100
Switch(config-if)# spanning-tree port disable
Switch(config-if)# ethernet cfm mep down mpid 202 domain md1 vlan 5 interval 1
Switch(config-if)# ethernet cfm mep crosscheck mpid 302 domain md1 vlan 5 mac
a0cd.ce44.5514
Switch(config-if)# no shutdown
Switch(config-if)# exit
Switch(config)# g8032 ring-id 1 east-interface eth-0-9 west-interface eth-0-20
Switch(g8032-config-switch)# instance 1
Switch(g8032-config-switch)# control-vlan 100
Switch(g8032-config-switch)# domain md1 service mal
Switch(g8032-config-switch)# ring enable
```

step 4 Switch2 validation

```
Switch# show g8032
RingID MajorRing State East Status West Status
-----
1 N/A Pending eth-0-9 Blocked eth-0-20 Forward

Control Vlan : 100
MD Name : md1
Service Id : ma1
Is Enabled : Yes
Mode : Revertive
Node Role : N/A
Is Sub_ring : No
Protect Instance : 1
Wait-to-restore : 05:00
Hold-off Timer : 0 (msecs)
Guard Timer : 500 (msecs)
WTB Timer : 5500 (msecs)
RAPS MEL : 7
Is Forward-to-cpu : 1
-----

Switch# show ethernet cfm maintenance-points
#####Local MEP:
Dir-Direction;
L-Level;
MPID Dir DOMAIN L VLAN PORT CC-Status MAC-Address RDI Interval
-----
201 down md1 5 5 eth-0-9 Enabled e03e.b1e1.3309 False 3.3ms
202 down md1 5 5 eth-0-20 Enabled e03e.b1e1.3314 False 3.3ms

#####Remote MEP:
MPID LEVEL VLAN Remote Mac RDI FLAGS STATE
-----
101 5 5 104e.40d1.e309 False Mac_config Up
302 5 5 a0cd.ce44.5514 False Mac_config Up
```

step 5 Configuration of Switch3

```
Switch# configure terminal
Enter configuration commands, one per line. End with CNTL/Z.
Switch(config)# vlan database
Switch(config-vlan)# vlan 10-100
Switch(config-vlan)# vlan 5
Switch(config-vlan)# exit
Switch(config)# spanning-tree mode mstp
Switch(config)# spanning-tree mst configuration
Switch(config-mst)# instance 1 vlan 10-99
Switch(config-mst)# exit
Switch(config)# no ip igmp snooping vlan 100
Switch(config)# ethernet cfm enable
Switch(config)# ethernet cfm domain md1 level 5
Switch(config-ether-cfm)# service ma1 vlan 5
```



```

Switch(config-ether-cfm)# exit
Switch(config)# ethernet cfm cc enable domain md1 vlan 5
Switch(config)# interface eth-0-9
Switch(config-if)# switchport mode trunk
Switch(config-if)# switchport trunk allowed vlan add 10-100
Switch(config-if)# spanning-tree port disable
Switch(config-if)# ethernet cfm mep down mpid 301 domain md1 vlan 5 interval 1
Switch(config-if)# ethernet cfm mep crosscheck mpid 401 domain md1 vlan 5 mac
b2d0.60e4.c309
Switch(config-if)# no shutdown
Switch(config-if)# exit
Switch(config)# interface eth-0-20
Switch(config-if)# switchport mode trunk
Switch(config-if)# switchport trunk allowed vlan add 10-100
Switch(config-if)# spanning-tree port disable
Switch(config-if)# ethernet cfm mep down mpid 302 domain md1 vlan 5 interval 1
Switch(config-if)# ethernet cfm mep crosscheck mpid 202 domain md1 vlan 5 mac
e03e.b1e1.3314
Switch(config-if)# no shutdown
Switch(config-if)# exit
Switch(config)# g8032 ring-id 1 east-interface eth-0-9 west-interface eth-0-20
Switch(g8032-config-switch)# instance 1
Switch(g8032-config-switch)# control-vlan 100
Switch(g8032-config-switch)# domain md1 service ma1
Switch(g8032-config-switch)# ring enable

```

step 6 Switch3 validation

```

Switch# show g8032

```

RingID	MajorRing	State	East	Status	West	Status
1	N/A	Pending	eth-0-9	Blocked	eth-0-20	Forward

```

Control Vlan          : 100
MD Name               : md1
Service Id            : ma1
Is Enabled             : Yes
Mode                  : Revertive
Node Role              : N/A
Is Sub_ring           : No
Protect Instance      : 1
Wait-to-restore       : 05:00
Hold-off Timer        : 0 (msecs)
Guard Timer           : 500 (msecs)
WTB Timer              : 5500 (msecs)
RAPS MEL              : 7
Is Forward-to-cpu    : 1

```

```

Switch# show ethernet cfm maintenance-points
#####Local MEP:
Dir-Direction;
I-Level;
MPID Dir  DOMAIN          L VLAN PORT          CC-Status MAC-Address  RDI  Interval

```

```

301    down md1          5 11   eth-0-9   Enabled  a0cd.ce44.5509 False 3.3ms
302    down md1          5 11   eth-0-20  Enabled  a0cd.ce44.5514 False 3.3ms

#####Remote MEP:
MPID  LEVEL VLAN Remote Mac      RDI   FLAGS      STATE
-----
401    5     11   b2d0.60e4.c309 False Mac_config Up
202    5     11   e03e.b1e1.3314 False Mac_config Up

```

step 7 Configuration of Switch4

```

Switch# configure terminal
Enter configuration commands, one per line. End with CNTL/Z.
Switch(config)# vlan database
Switch(config-vlan)# vlan 10-100
Switch(config-vlan)# vlan 5
Switch(config-vlan)# exit
Switch(config)# spanning-tree mode mstp
Switch(config)# spanning-tree mst configuration
Switch(config-mst)# instance 1 vlan 10-99
Switch(config-mst)# exit
Switch(config)# no ip igmp snooping vlan 100
Switch(config)# ethernet cfm enable
Switch(config)# ethernet cfm domain md1 level 5
Switch(config-ether-cfm)# service ma1 vlan 5
Switch(config-ether-cfm)# exit
Switch(config)# ethernet cfm cc enable domain md1 vlan 5
Switch(config)# interface eth-0-9
Switch(config-if)# switchport mode trunk
Switch(config-if)# switchport trunk allowed vlan add 10-100
Switch(config-if)# spanning-tree port disable
Switch(config-if)# ethernet cfm mep down mpid 401 domain md1 vlan 5 interval 1
Switch(config-if)# ethernet cfm mep crosscheck mpid 301 domain md1 vlan 5 mac
a0cd.ce44.5509
Switch(config-if)# no shutdown
Switch(config-if)# exit
Switch(config)# interface eth-0-20
Switch(config-if)# switchport mode trunk
Switch(config-if)# switchport trunk allowed vlan add 10-100
Switch(config-if)# spanning-tree port disable
Switch(config-if)# ethernet cfm mep down mpid 402 domain md1 vlan 5 interval 1
Switch(config-if)# ethernet cfm mep crosscheck mpid 102 domain md1 vlan 5 mac
104e.40d1.e314
Switch(config-if)# no shutdown
Switch(config-if)# exit
Switch(config)# g8032 ring-id 1 east-interface eth-0-9 west-interface eth-0-20
Switch(g8032-config-switch)# instance 1
Switch(g8032-config-switch)# control-vlan 100
Switch(g8032-config-switch)# domain md1 service ma1
Switch(g8032-config-switch)# ring enable

```

step Switch4 validation

```
Switch# show g8032
RingID MajorRing State East Status West Status
-----
1 N/A Pending eth-0-9 Blocked eth-0-20 Forward

Control Vlan : 100
MD Name : md1
Service Id : ma1
Is Enabled : Yes
Mode : Revertive
Node Role : N/A
Is Sub_ring : No
Protect Instance : 1
Wait-to-restore : 05:00
Hold-off Timer : 0 (msecs)
Guard Timer : 500 (msecs)
WTB Timer : 5500 (msecs)
RAPS MEL : 7
Is Forward-to-cpu : 1
-----

Switch# show ethernet cfm maintenance-points
#####Local MEP:
Dir-Direction;
L-Level;
MPID Dir DOMAIN L VLAN PORT CC-Status MAC-Address RDI Interval
-----
401 down md1 5 11 eth-0-9 Enabled b2d0.60e4.c309 False 3.3ms
402 down md1 5 11 eth-0-20 Enabled b2d0.60e4.c314 False 3.3ms

#####Remote MEP:
MPID LEVEL VLAN Remote Mac RDI FLAGS STATE
-----
301 5 11 a0cd.ce44.5509 False Mac_config Up
102 5 11 104e.40d1.e314 False Mac_config Up
```

16.7 Configuring UDLD

16.7.1 Overview

Function Introduction

The Unidirectional Link Detection protocol is a light-weight protocol that can be used to detect and disable one-way connections before they create dangerous situations such as Spanning Tree loops or other protocol malfunctions.

Principle Description

N/A

16.7.2 Configuration

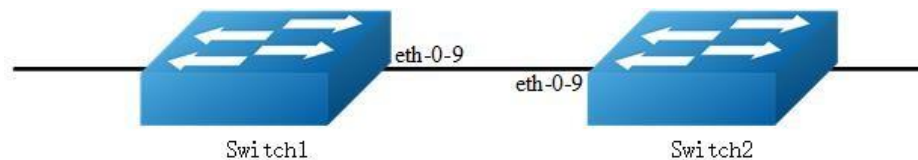

Figure 16-14 UDLD

The following configurations are same on Switch1 and Switch2.

step 1 Enter the configure mode

```
Switch# configure terminal
```

step 2 Enter the interface configure mode and enable udld

```
Switch(config)# interface eth-0-9
Switch(config-if)# no shutdown
Switch(config-if)# udld port
Switch(config-if)# exit
```

step 3 Enable udld globally

```
Switch(config)# udld enable
```

step 4 Set the message interval (optional)

If the message is not specified, use the default value: 15 seconds.

```
Switch(config)# udld message interval 10
```

step 5 Exit the configure mode

```
Switch(config)# end
```

step 6 Validation

Display the result on Switch1.

```
Switch# show uddl eth-0-9
Interface eth-0-9
---
UDLD mode          : normal
Operation state    : Bidirectional
Message interval   : 10
Message timeout    : 3
Neighbor 1
---
Device ID          : 4c7b.8510.ab00
Port ID            : eth-0-9
Device Name        : Switch
Message interval   : 10
Message timeout    : 3
Link Status        : bidirectional
Expiration time    : 29
```

Display the result on Switch2.

```
Switch# show uddl eth-0-9
Interface eth-0-9
---
UDLD mode          : normal
Operation state    : Bidirectional
Message interval   : 10
Message timeout    : 3
Neighbor 1
---
Device ID          : 28bc.83db.8400
Port ID            : eth-0-9
Device Name        : Switch
Message interval   : 10
Message timeout    : 3
Link Status        : bidirectional
Expiration time    : 23
```

16.7.3 Application cases

N/A

16.8 Configuring ERPS

16.8.1 Overview

Function Introduction

ERPS technology increases the availability and robustness of Ethernet rings. In the event that a fiber cut occurs, ERPS converges in less than one second, often in less than 50 milliseconds.

The main idea is described as the following. ERPS operates by declaring an ERPS domain on a single ring. On that ring domain, one switch, or node, is designated the master node, while all other nodes are designated as transit nodes. One port of the master node is designated as the master node's primary port to the ring; another port is designated as the master node's secondary port to the ring. In normal operation, the master node blocks the secondary port for all non-ERPS traffic belonging to this ERPS domain, thereby avoiding a loop in the ring. Keep-alive messages are sent by the master node in a pre-set time interval. Transit nodes in the ring domain will forward the ERPS messages. Once a link failure event occurs, the master node will detect this either by receiving the link-down message sent by the node adjacent to the failed link or by the timeout of the keep-alive message. After link failure is detected, master node will open the secondary port for data traffic to re-route the traffic.

Principle Description

Reference: RFC 3619

16.8.2 Configuration

ERPS is a soft-state protocol. The main requirement is to enable ERPS on desired devices, and configure the ERPS information correctly for various network topologies.

This section provides ERPS configuration examples for their typical network topologies.

Configuring ERPS for a Single-Ring Topology

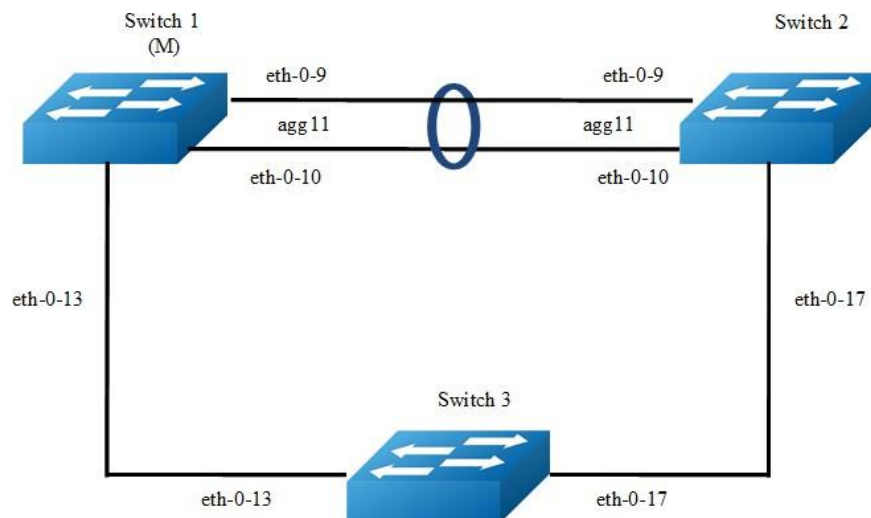

Figure 16-15 ERPS

Configure same ERPS domain and ring at Switch1, Switch2 and Switch3. Switch1 is configured as ERPS master node and other two switches are configured as ERPS transit nodes. Interface agg11, which has two members called eth-0-9 and eth-0-10, is configured as primary interface at Switch1 and eth-0-13 is configured as secondary interface.



NOTE

The ports accessing an ERPS ring must be configured as trunk ports, permitting the traffic of data VLANs to pass through. If the switch is enabled stacking, the port of ERPS ring should not on slave stacking device.

- The ports accessing an ERPS ring must be configured as the members of the control VLAN, allowing the ERPS packets to be sent and received.
- STP on ports accessing ERPS rings must be disabled.
- Only one node can be configured as master node.
- Control VLAN must not be configured as Layer 3 interface.
- VLAN mapping must not be enabled on the ERPS ports.
- Native VLAN of a port accessing an ERPS ring must not be set as the primary control VLAN or the secondary control VLAN.

The following configuration should be operated on all switches if the switch ID is not specified.

step 1 Enter the configure mode

```
Switch# configure terminal
```

step 2 Enter the vlan configure mode and create the vlan

```
Switch(config)# vlan database  
Switch(config-vlan)# vlan 15  
Switch(config-vlan)# exit
```

step 3 Enter the interface configure mode and set the attributes of the interface

As the topology shows, eth-0-9 and eth-0-10 of Switch1 and Switch2 join agg 11 and connect to each other directly. eth-0-13 of Switch1 and Switch3 connect to each other directly. eth-0-17 of Switch2 and Switch3 connect to each other directly.

Interface agg 11 configuration for Switch1 and Switch2:

```
Switch(config)# interface eth-0-9  
Switch(config-if)# no shutdown  
Switch(config-if)# switchport mode trunk  
Switch(config-if)# switchport trunk allowed vlan add 15  
Switch(config-if)# static-channel-group 11  
Switch(config-if)# exit  
  
Switch(config)# interface eth-0-10  
Switch(config-if)# no shutdown  
Switch(config-if)# switchport mode trunk  
Switch(config-if)# switchport trunk allowed vlan add 15  
Switch(config-if)# static-channel-group 11  
Switch(config-if)# exit  
  
Switch(config)# interface agg11  
Switch(config-if)# spanning-tree port disable
```

Interface eth-0-13 configuration for Switch1 and Switch3:

```
Switch(config)# interface eth-0-13  
Switch(config-if)# no shutdown  
Switch(config-if)# switchport mode trunk  
Switch(config-if)# switchport trunk allowed vlan add 15  
Switch(config-if)# spanning-tree port disable  
Switch(config-if)# exit
```

Interface eth-0-17 configuration for Switch2 and Switch3:

```
Switch(config)# interface eth-0-17  
Switch(config-if)# no shutdown  
Switch(config-if)# switchport mode trunk  
Switch(config-if)# switchport trunk allowed vlan add 15  
Switch(config-if)# spanning-tree port disable  
Switch(config-vlan)# exit
```

step 4 Create and enable ERPS domain.

ERPS domain for Switch1:

```
Switch(config)# erps 11
Switch(config)# erps 11 primary control vlan 15
Switch(config)# erps 11 mstp instance 0
Switch(config)# erps 11 ring 1 level primary
Switch(config)# erps 11 ring 1 mode master
Switch(config)# erps 11 ring 1 primary interface agg11
Switch(config)# erps 11 ring 1 secondary interface eth-0-13
Switch(config)# erps 11 ring 1 enable
Switch(config)# erps 11 enable
```

ERPS domain for Switch2:

```
Switch(config)# erps 11
Switch(config)# erps 11 primary control vlan 15
Switch(config)# erps 11 mstp instance 0
Switch(config)# erps 11 ring 1 level primary
Switch(config)# erps 11 ring 1 mode transit
Switch(config)# erps 11 ring 1 primary interface agg11
Switch(config)# erps 11 ring 1 secondary interface eth-0-17
Switch(config)# erps 11 ring 1 enable
Switch(config)# erps 11 enable
```

ERPS domain for Switch3:

```
Switch(config)# erps 11
Switch(config)# erps 11 primary control vlan 15
Switch(config)# erps 11 mstp instance 0
Switch(config)# erps 11 ring 1 level primary
Switch(config)# erps 11 ring 1 mode transit
Switch(config)# erps 11 ring 1 primary interface eth-0-17
Switch(config)# erps 11 ring 1 secondary interface eth-0-13
Switch(config)# erps 11 ring 1 enable
Switch(config)# erps 11 enable
```

step 5 Exit the configure mode

```
Switch(config)# end
```

step 6 Validation

Display the result on Switch1.

```
Switch# show erps 11
ERPS domain ID: 11
ERPS domain name: ERPS0011
ERPS domain mode: normal
ERPS domain primary control VLAN ID: 15
ERPS domain sub control VLAN ID: 0
ERPS domain hello timer interval: 1 second(s)
```

```

ERPS domain fail timer interval: 3 second(s)
ERPS domain protected mstp instance: 0
ERPS ring ID: 1
ERPS ring level: primary
ERPS ring 1 node mode: master
ERPS ring 1 node state: complete
ERPS ring 1 primary interface name: agg11          state:unblock
ERPS ring 1 secondary interface name: eth-0-13    state:block
ERPS ring 1 stats:
Sent:
  total packets:51
  hello packets:47                                ring-up-flush-fdb packets:2
  ring-down-flush-fdb packets:2                  link-down packets:0
  edge-hello packets:0                           major-fault packets:0
Received:
  total packets:21
  hello packets:21                                ring-up-flush-fdb packets:0
  ring-down-flush-fdb packets:0                  link-down packets:0
  edge-hello packets:0                           major-fault packets:0

```

Display the result on Switch2.

```

Switch# show erps 11
ERPS domain ID: 11
ERPS domain name: ERPS0011
ERPS domain mode: normal
ERPS domain primary control VLAN ID: 15
ERPS domain sub control VLAN ID: 0
ERPS domain hello timer interval: 1 second(s)
ERPS domain fail timer interval: 3 second(s)
ERPS domain protected mstp instance: 0
ERPS ring ID: 1
ERPS ring level: primary
ERPS ring 1 node mode: transit
ERPS ring 1 node state: link up
ERPS ring 1 primary interface name: agg11          state:unblock
ERPS ring 1 secondary interface name: eth-0-17    state:unblock
ERPS ring 1 stats:
Sent:
  total packets:0
  hello packets:0                                ring-up-flush-fdb packets:0
  ring-down-flush-fdb packets:0                  link-down packets:0
  edge-hello packets:0                           major-fault packets:0
Received:
  total packets:114
  hello packets:113                              ring-up-flush-fdb packets:1
  ring-down-flush-fdb packets:0                  link-down packets:0
  edge-hello packets:0                           major-fault packets:0

```

Display the result on Switch3.

```

Switch# show erps 11
ERPS domain ID: 11
ERPS domain name: ERPS0011
ERPS domain mode: normal
ERPS domain primary control VLAN ID: 15

```

```

ERPS domain sub control VLAN ID: 0
ERPS domain hello timer interval: 1 second(s)
ERPS domain fail timer interval: 3 second(s)
ERPS domain protected mstp instance: 0
ERPS ring ID: 1
ERPS ring level: primary
ERPS ring 1 node mode: transit
ERPS ring 1 node state: link up
ERPS ring 1 primary interface name: eth-0-17      state:unblock
ERPS ring 1 secondary interface name: eth-0-13    state:unblock
ERPS ring 1 stats:
Sent:
  total packets:0
  hello packets:0                               ring-up-flush-fdb packets:0
  ring-down-flush-fdb packets:0                 link-down packets:0
  edge-hello packets:0                           major-fault packets:0
Received:
  total packets:130
  hello packets:129                             ring-up-flush-fdb packets:1
  ring-down-flush-fdb packets:0                 link-down packets:0
  edge-hello packets:0                           major-fault packets:0

```

Configuring an Intersecting-Ring Topology

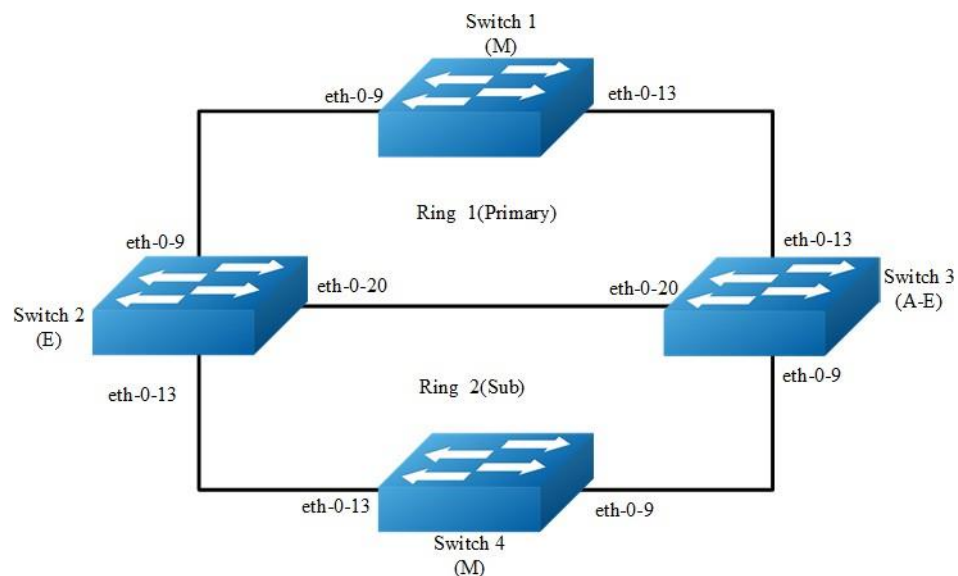

Figure 16-16 ERPS

Configure the same ERPS domain at Switch1, Switch2, Switch3 and Switch4. Switch1, Switch2 and Switch3 consist of ERPS primary ring 1 while Switch2, Switch3 and Switch4 consist of ERPS sub ring 2. Switch1 is configured as ERPS ring 1 master node and other two switches are configured as ERPS transit nodes while Switch4 is configured as ERPS ring 2 master node. In addition Switch2 is configured as ERPS ring 2 master node. In addition Switch2 is configured as edge node and Switch3 is configured as assistant-edge node.

The ports accessing an ERPS ring must be configured as trunk ports, permitting the traffic of data VLANs to pass through.

step 1 Enter the configure mode

```
Switch# configure terminal
```

step 2 Enter the vlan configure mode and create the vlan

```
Switch(config)# vlan database
Switch(config-vlan)# vlan 11,12
Switch(config-vlan)# exit
```

step 3 Enter the interface configure mode and set the attributes of the interface

```
Switch(config)# interface eth-0-9
Switch(config-if)# no shutdown
Switch(config-if)# switchport mode trunk
Switch(config-if)# switchport trunk allowed vlan add 11,12
Switch(config-if)# spanning-tree port disable
Switch(config-if)# exit

Switch(config)# interface eth-0-13
Switch(config-if)# no shutdown
Switch(config-if)# switchport mode trunk
Switch(config-if)# switchport trunk allowed vlan add 11,12
Switch(config-if)# spanning-tree port disable
Switch(config-if)# exit
```

Interface eth-0-20 configuration for Switch2 and Switch3:

```
Switch(config)# interface eth-0-20
Switch(config-if)# no shutdown
Switch(config-if)# switchport mode trunk
Switch(config-if)# switchport trunk allowed vlan add 11,12
Switch(config-if)# spanning-tree port disable
Switch(config-if)# exit
```

step 4 Create and enable ERPS domain.

ERPS domain for Switch1:

```
Switch(config)# erps 1
Switch(config)# erps 1 primary control vlan 11
Switch(config)# erps 1 sub control vlan 12
Switch(config)# erps 1 mstp instance 0
Switch(config)# erps 1 ring 1 level primary
Switch(config)# erps 1 ring 1 mode master
Switch(config)# erps 1 ring 1 primary interface eth-0-9
Switch(config)# erps 1 ring 1 secondary interface eth-0-13
```

```
Switch(config)# erps 1 ring 1 enable
Switch(config)# erps 1 enable
```

ERPS domain for Switch2:

```
Switch(config)# erps 1
Switch(config)# erps 1 primary control vlan 11
Switch(config)# erps 1 sub control vlan 12
Switch(config)# erps 1 mstp instance 0
Switch(config)# erps 1 ring 1 level primary
Switch(config)# erps 1 ring 1 mode transit
Switch(config)# erps 1 ring 1 primary interface eth-0-9
Switch(config)# erps 1 ring 1 secondary interface eth-0-20
Switch(config)# erps 1 ring 1 enable

Switch(config)# erps 1 ring 2 level sub
Switch(config)# erps 1 ring 2 edge-mode edge
Switch(config)# erps 1 ring 2 edge interface eth-0-13
Switch(config)# erps 1 ring 2 common interface eth-0-20
Switch(config)# erps 1 ring 2 srpt disable
Switch(config)# erps 1 ring 2 enable
Switch(config)# erps 1 enable
```

ERPS domain for Switch3:

```
Switch(config)# erps 1
Switch(config)# erps 1 primary control vlan 11
Switch(config)# erps 1 sub control vlan 12
Switch(config)# erps 1 mstp instance 0
Switch(config)# erps 1 ring 1 level primary
Switch(config)# erps 1 ring 1 mode transit
Switch(config)# erps 1 ring 1 primary interface eth-0-13
Switch(config)# erps 1 ring 1 secondary interface eth-0-20
Switch(config)# erps 1 ring 1 enable

Switch(config)# erps 1 ring 2 level sub
Switch(config)# erps 1 ring 2 edge-mode assistant-edge
Switch(config)# erps 1 ring 2 edge interface eth-0-9
Switch(config)# erps 1 ring 2 common interface eth-0-20
Switch(config)# erps 1 ring 2 enable
Switch(config)# erps 1 enable
```

ERPS domain for Switch4:

```
Switch(config)# erps 1
Switch(config)# erps 1 sub control vlan 12
Switch(config)# erps 1 mstp instance 0
Switch(config)# erps 1 ring 2 level sub
Switch(config)# erps 1 ring 2 mode master
Switch(config)# erps 1 ring 2 primary interface eth-0-9
Switch(config)# erps 1 ring 2 secondary interface eth-0-13
Switch(config)# erps 1 ring 2 enable
Switch(config)# erps 1 enable
```

step 5 Exit the configure mode

```
Switch(config)# end
```

step 6 Validation

Display the result on Switch1.

```
Switch# show erps 1
ERPS domain ID: 1
ERPS domain name: ERPS001
ERPS domain mode: normal
ERPS domain primary control VLAN ID: 11
ERPS domain sub control VLAN ID: 12
ERPS domain hello timer interval: 1 second(s)
ERPS domain fail timer interval: 3 second(s)
ERPS domain protected mstp instance: 0
ERPS ring ID: 1
ERPS ring level: primary
ERPS ring 1 node mode: master
ERPS ring 1 node state: complete
ERPS ring 1 primary interface name: eth-0-9      state:unblock
ERPS ring 1 secondary interface name: eth-0-13  state:block
ERPS ring 1 stats:
Sent:
  total packets:1310
  hello packets:1303                ring-up-flush-fdb packets:3
  ring-down-flush-fdb packets:4     link-down packets:0
  edge-hello packets:0              major-fault packets:0
Received:
  total packets:921
  hello packets:921                ring-up-flush-fdb packets:0
  ring-down-flush-fdb packets:0     link-down packets:0
  edge-hello packets:0              major-fault packets:0
```

Display the result on Switch2.

```
Switch# show erps 1
ERPS domain ID: 1
ERPS domain name: ERPS001
ERPS domain mode: normal
ERPS domain primary control VLAN ID: 11
ERPS domain sub control VLAN ID: 12
ERPS domain hello timer interval: 1 second(s)
ERPS domain fail timer interval: 3 second(s)
ERPS domain protected mstp instance: 0
ERPS ring ID: 1
ERPS ring level: primary
ERPS ring 1 node mode: transit
ERPS ring 1 node state: link up
ERPS ring 1 primary interface name: eth-0-9      state:unblock
ERPS ring 1 secondary interface name: eth-0-20   state:unblock
ERPS ring 1 stats:
Sent:
```

```

total packets:0
hello packets:0                ring-up-flush-fdb packets:0
ring-down-flush-fdb packets:0  link-down packets:0
edge-hello packets:0          major-fault packets:0
Received:
total packets:988
hello packets:985              ring-up-flush-fdb packets:2
ring-down-flush-fdb packets:1  link-down packets:0
edge-hello packets:0          major-fault packets:0
ERPS ring ID: 2
ERPS ring level: sub
ERPS ring 2 node mode: transit
ERPS ring 2 edge node mode: edge
ERPS ring 2 node state: link up
ERPS ring 2 edge interface name: eth-0-13    state: unblock
ERPS ring 2 common interface name: eth-0-20  state: unblock
ERPS ring 2 SRPT is disabled
ERPS ring 2 stats:
Sent:
total packets:0
hello packets:0                ring-up-flush-fdb packets:0
ring-down-flush-fdb packets:0  link-down packets:0
edge-hello packets:0          major-fault packets:0
Received:
total packets:858
hello packets:856              ring-up-flush-fdb packets:1
ring-down-flush-fdb packets:1  link-down packets:0
edge-hello packets:0          major-fault packets:0

```

Display the result on Switch3.

```

Switch# show erps 1
ERPS domain ID: 1
ERPS domain name: ERPS001
ERPS domain mode: normal
ERPS domain primary control VLAN ID: 11
ERPS domain sub control VLAN ID: 12
ERPS domain hello timer interval: 1 second(s)
ERPS domain fail timer interval: 3 second(s)
ERPS domain protected mstp instance: 0
ERPS ring ID: 1
ERPS ring level: primary
ERPS ring 1 node mode: transit
ERPS ring 1 node state: link up
ERPS ring 1 primary interface name: eth-0-13    state:unblock
ERPS ring 1 secondary interface name: eth-0-20  state:unblock
ERPS ring 1 stats:
Sent:
total packets:0
hello packets:0                ring-up-flush-fdb packets:0
ring-down-flush-fdb packets:0  link-down packets:0
edge-hello packets:0          major-fault packets:0
Received:
total packets:645
hello packets:644              ring-up-flush-fdb packets:1
ring-down-flush-fdb packets:0  link-down packets:0

```

```

edge-hello packets:0          major-fault packets:0
ERPS ring ID: 2
ERPS ring level: sub
ERPS ring 2 node mode: transit
ERPS ring 2 edge node mode: assistant edge
ERPS ring 2 node state: link up
ERPS ring 2 edge interface name: eth-0-9      state: unblock
ERPS ring 2 common interface name: eth-0-20   state: unblock
ERPS ring 2 stats:
Sent:
  total packets:0
  hello packets:0              ring-up-flush-fdb packets:0
  ring-down-flush-fdb packets:0  link-down packets:0
  edge-hello packets:0         major-fault packets:0
Received:
  total packets:645
  hello packets:644           ring-up-flush-fdb packets:1
  ring-down-flush-fdb packets:0  link-down packets:0
  edge-hello packets:0         major-fault packets:0

```

Display the result on Switch4.

```

Switch# show erps 1
ERPS domain ID: 1
ERPS domain name: ERPS001
ERPS domain mode: normal
ERPS domain primary control VLAN ID: 0
ERPS domain sub control VLAN ID: 12
ERPS domain hello timer interval: 1 second(s)
ERPS domain fail timer interval: 3 second(s)
ERPS domain protected mstp instance: 0
ERPS ring ID: 2
ERPS ring level: sub
ERPS ring 2 node mode: master
ERPS ring 2 node state: complete
ERPS ring 2 primary interface name: eth-0-9      state:unblock
ERPS ring 2 secondary interface name: eth-0-13   state:block
ERPS ring 2 stats:
Sent:
  total packets:814
  hello packets:810           ring-up-flush-fdb packets:2
  ring-down-flush-fdb packets:2  link-down packets:0
  edge-hello packets:0         major-fault packets:0
Received:
  total packets:774
  hello packets:774           ring-up-flush-fdb packets:0
  ring-down-flush-fdb packets:0  link-down packets:0
  edge-hello packets:0         major-fault packets:0
Switch#

```

16.8.3 Application cases

N/A

16.9 Configuring Smart Link

16.9.1 Overview

Function Introduction

The Smart Link is a simple but practical technology of fast link protection. It is a solution specific to dual uplink networking to fulfill redundancy and fast migration of active and standby links.

Every smart-link group is included a pair of a layer 2 interfaces where one interface is configured to act as a standby to the other. The feature provides an alternative solution to the STP. Users can disable STP and still retain basic link redundancy. The feature also support load-balancing so than both interfaces simultaneously forward the traffic.

Principle Description

N/A

16.9.2 Configuration

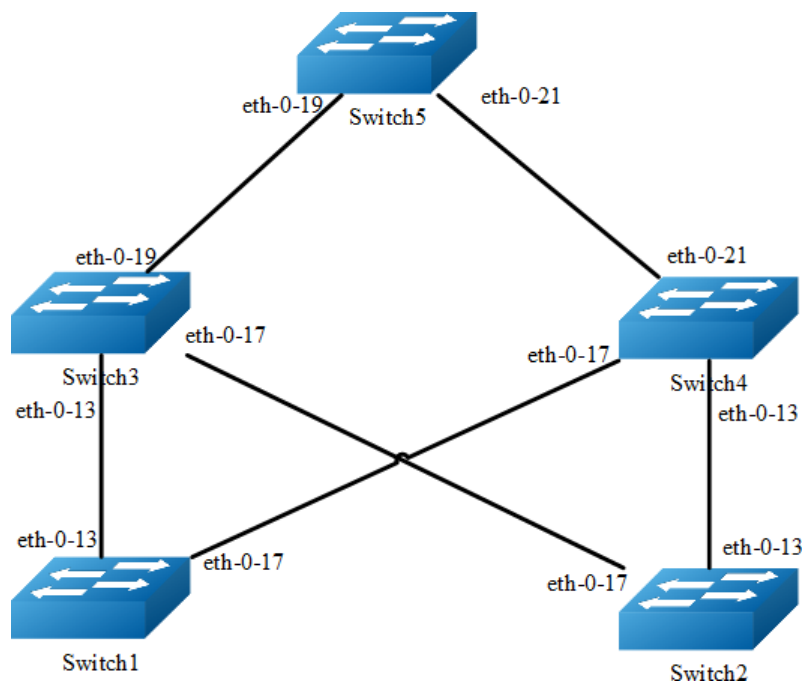

Figure 16-17 Smart-Link Typical Topology

The figure above is a typical smart-link application. The Switch1 and Switch2 are configured smart-link group. Switch3, Switch4 and Switch5 are configured smart-link flush receiver.

To configure smart-link group, some configuration should be configured before it.

- VLANs should be configured.
- MSTP instance should be configured.
- Spanning-tree should be disabled in the interface.
- About above configurations, please see the related references.

The following configuration should be operated on all switches if the switch ID is not specified.

step 1 Enter the configure mode

```
Switch# configure terminal
```

step 2 Enter the vlan configure mode and create the vlan

```
Switch(config)# vlan database
Switch(config-vlan)# vlan 2-20
Switch(config-vlan)# exit
```

step 3 Set the spanning tree mode and create mstp instance

Create the mstp instance on Switch1 and Switch2:

```
Switch(config)# spanning-tree mode mstp
Switch(config)# spanning-tree mst configuration
Switch(config-mst)# instance 1 vlan 1
Switch(config-mst)# instance 2 vlan 2
Switch(config-mst)# instance 3 vlan 3
Switch(config-mst)# instance 10 vlan 10
Switch(config-mst)# exit
```

step 4 Enter the interface configure mode and set the attributes of the interface

Interface configuration for Switch1 and Switch2:

```
Switch(config)# interface eth-0-13
Switch(config-if)# switchport mode trunk
Switch(config-if)# switchport trunk allowed vlan all
Switch(config-if)# spanning-tree port disable
```

```
Switch(config-if)# no shutdown
Switch(config-if)# exit

Switch(config)# interface eth-0-17
Switch(config-if)# switchport mode trunk
Switch(config-if)# switchport trunk allowed vlan all
Switch(config-if)# spanning-tree port disable
Switch(config-if)# no shutdown
Switch(config-if)# exit
```

Interface configuration for Switch3 and Switch4:

```
Switch(config)# interface eth-0-13
Switch(config-if)# switchport mode trunk
Switch(config-if)# no shutdown
Switch(config-if)# switchport trunk allowed vlan all
Switch(config-if)# smart-link flush receive control-vlan 10 password simple test
Switch(config-if)# exit

Switch(config)# interface eth-0-17
Switch(config-if)# no shutdown
Switch(config-if)# switchport mode trunk
Switch(config-if)# switchport trunk allowed vlan all
Switch(config-if)# smart-link flush receive control-vlan 10 password simple test
Switch (config-if)# exit
```

Interface eth-0-19 configuration for Switch3:

```
Switch(config)# interface eth-0-19
Switch(config-if)# switchport mode trunk
Switch(config-if)# no shutdown
Switch(config-if)# switchport trunk allowed vlan all
Switch(config-if)# exit
```

Interface eth-0-21 configuration for Switch4:

```
Switch(config)# interface eth-0-21
Switch(config-if)# switchport mode trunk
Switch(config-if)# no shutdown
Switch(config-if)# switchport trunk allowed vlan all
Switch(config-if)# exit
```

Interface configuration for Switch5:

```
Switch(config)# interface eth-0-19
Switch(config-if)# switchport mode trunk
Switch(config-if)# no shutdown
Switch(config-if)# switchport trunk allowed vlan all
Switch(config-if)# smart-link flush receive control-vlan 10 password simple test
Switch(config-if)# exit

Switch(config)# interface eth-0-21
Switch(config-if)# switchport mode trunk
Switch(config-if)# no shutdown
Switch(config-if)# switchport trunk allowed vlan all
```

```
Switch(config-if)# smart-ink flush receive control-vlan 10 password simple test
Switch(config-if)# exit
```

step 5 Create smart link group and set the attributes of the group

Create smart link group on Switch1 and Switch2:

```
Switch(config)# smart-link group 1
Switch(config-smlk-group)# interface eth-0-13 master
Switch(config-smlk-group)# interface eth-0-17 slave
Switch(config-smlk-group)# protected mstp instance 1
Switch(config-smlk-group)# protected mstp instance 2
Switch(config-smlk-group)# protected mstp instance 3
Switch(config-smlk-group)# protected mstp instance 10
Switch(config-smlk-group)# load-balance instance 3
Switch(config-smlk-group)# restore time 40
Switch(config-smlk-group)# restore enable
Switch(config-smlk-group)# flush send control-vlan 10 password simple test
Switch(config-smlk-group)# group enable
Switch(config-smlk-group)# exit
```

step 6 Disable the smart link relay function

Configure on Switch5:

```
Switch(config)# no smart-link relay enable
```

step 7 Exit the configure mode

```
Switch(config)# end
```

step 8 Validation

Display the result on Switch1.

```
Switch1# show smart-link group 1
Smart-link group 1 information:
The smart-link group was enabled.
=====
Auto-restore:
  state      time      count     Last-time
  enabled    40        0         N/A
=====
Protected instance: 1 2 3
Load balance instance: 3
Flush sender , Control-vlan ID: 10      Password:test
=====
INTERFACE:
Role  Member   DownCount Last-Down-Time  FlushCount Last-Flush-Time
MASTER eth-0-13  0          N/A              0          N/A
SLAVE  eth-0-17  0          N/A              0          N/A
```

```

=====
Instance states in the member interfaces:
  A - ACTIVE ,   B -BLOCK , D-The interface is link-down
Map-instance-ID  MASTER(eth-0-13)  SLAVE(eth-0-17)
    1             A             B
    2             A             B
    3             B             A

```

Display the result on Switch2.

```

Switch# show smart-link group 1
Smart-link group 1 information:
The smart-link group was enabled.
=====
Auto-restore:
  state      time      count    Last-time
  enabled    40         0        N/A
=====
Protected instance: 1 2 3
Load balance instance: 3
Flush sender , Control-vlan ID: 10   Password:test
=====
INTERFACE:
Role  Member      DownCount Last-Down-Time  FlushCount Last-Flush-Time
-----
MASTER eth-0-13  0      N/A              0      N/A
SLAVE  eth-0-17  0      N/A              0      N/A
=====
Instance states in the member interfaces:
  A - ACTIVE ,   B -BLOCK , D-The interface is link-down
Map-instance-ID  MASTER(eth-0-13)  SLAVE(eth-0-17)
    1             A             B
    2             A             B
    3             B             A

```

Display the result on Switch3.

```

Switch# show smart-link
Relay smart-link flush packet is enabled
Smart-link flush receiver interface:
  eth-0-13  control-vlan:10  password:test
  eth-0-17  control-vlan:10  password:test
Smart-link received flush packet number:0
Smart-link processed flush packet number:0
Smart link Group Number is 0.

```

Display the result on Switch4.

```

Switch# show smart-link
Relay smart-link flush packet is enabled
Smart-link flush receiver interface:
  eth-0-13  control-vlan:10  password:test
  eth-0-17  control-vlan:10  password:test
Smart-link received flush packet number:0
Smart-link processed flush packet number:0
Smart link Group Number is 0.

```

Display the result on Switch5.

```
Switch# show smart-link
Relay smart-link flush packet is disabled
Smart-link flush receiver interface:
  eth-0-21   control-vlan:10   password: test
  eth-0-19   control-vlan:10   password:test
Smart-link received flush packet number:0
Smart-link processed flush packet number:0
Smart link Group Number is 0.
```

16.9.3 Application cases

N/A

16.10 Configuring Multi-Link

16.10.1 Overview

Function Introduction

The Multi-Link is a simple but practical technology of fast link protection. It is a solution specific to multi-uplink networking to fulfill redundancy and fast migration of between links.

The feature is like smart link, but links extend to four instead of two.

Principle Description

N/A

16.10.2 Configuration

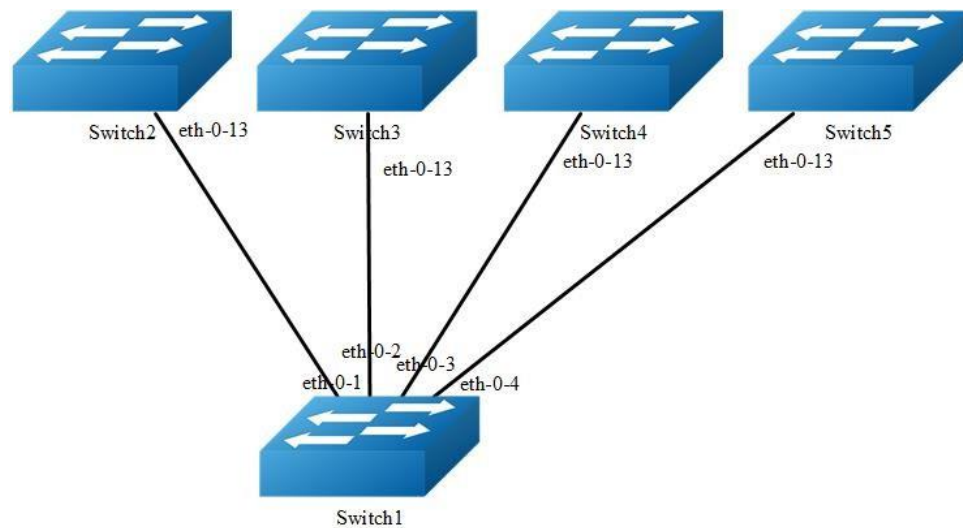

Figure 16-18 Multi-Link Typical Topology

The figure above is a typical multi-link application. The Switch1 are configured multi-link group. Switch2, Switch3, Switch4 and Switch5 are configured multi-link flush receiver.

To configure Multi-link group, some configuration should be configured before it.

- VLANs should be configured.
- MSTP instance should be configured.
- Spanning-tree should be disabled in the interface.
- About above configurations, please see the related references.
- The following configuration should be operated on all switches if the switch ID is not specified.

step 1 Enter the configure mode

```
Switch# configure terminal
```

step 2 Enter the vlan configure mode and create the vlan

```
Switch(config)# vlan database
Switch(config-vlan)# vlan 2-10
Switch(config-vlan)# exit
```

step 3 Set the spanning tree mode and create mstp instance

```
Switch(config)# spanning-tree mode mstp
Switch(config)# spanning-tree mst configuration
Switch(config-mst)# instance 1 vlan 1
Switch(config-mst)# instance 2 vlan 2
Switch(config-mst)# instance 3 vlan 3
Switch(config-mst)# instance 4 vlan 4-10
Switch(config-mst)# exit
```

step 4 Enter the interface configure mode and set the attributes of the interface

Interface configuration for Switch1:

```
Switch(config)# interface range eth-0-1 - 4
Switch(config-if)# switchport mode trunk
Switch(config-if)# switchport trunk allowed vlan all
Switch(config-if)# spanning-tree port disable
Switch(config-if)# no shutdown
Switch(config-if)# exit
```

Interface configuration for Switch1 ~ 5:

```
Switch(config)# interface eth-0-13
Switch(config-if)# switchport mode trunk
Switch(config-if)# switchport trunk allowed vlan all
Switch(config-if)# multi-link flush receive control-vlan 10 password simple test
Switch(config-if)# no shutdown
Switch(config-if)# exit
```

step 5 Create multi link group and set the attributes of the group

Create multi link group on Switch1:

```
Switch(config)# multi-link group 1
Switch(config-multilink-group)# interface eth-0-1 priority 1
Switch(config-multilink-group)# interface eth-0-2 priority 2
Switch(config-multilink-group)# interface eth-0-3 priority 3
Switch(config-multilink-group)# interface eth-0-4 priority 4
Switch(config-multilink-group)# protected mstp instance 1
Switch(config-multilink-group)# protected mstp instance 2
Switch(config-multilink-group)# protected mstp instance 3
Switch(config-multilink-group)# protected mstp instance 4
Switch(config-multilink-group)# load-balance instance 2 priority 2
Switch(config-multilink-group)# load-balance instance 3 priority 3
Switch(config-multilink-group)# load-balance instance 4 priority 4
Switch(config-multilink-group)# restore time 40
Switch(config-multilink-group)# restore enable
Switch(config-multilink-group)# flush send control-vlan 10 password simple test
Switch(config-multilink-group)# group enable
Switch(config-multilink-group)# exit
```

step 6 Exit the configure mode

```
Switch(config)# end
```

step 7 Validation

Display the result on Switch1.

```
Switch# show multi-link group 1
Multi-link group 1 information:
The multi-link group was enabled.
=====
Auto-restore:
  state      time      count    Last-time
  enabled    40        0        N/A
=====
Protected instance: 1 2 3 4
Load balance instance: 2(to P2) 3(to P3) 4(to P4)
Flush sender , Control-vlan ID: 10 Password:test
=====
INTERFACE:

| Role | Member  | DownCount | Last-Down-Time | FlushCount | Last-Flush-Time     |
|------|---------|-----------|----------------|------------|---------------------|
| PRI1 | eth-0-1 | 0         | N/A            | 1          | 2016/09/05,07:13:24 |
| PRI2 | eth-0-2 | 0         | N/A            | 1          | 2016/09/05,07:13:24 |
| PRI3 | eth-0-3 | 0         | N/A            | 1          | 2016/09/05,07:13:24 |
| PRI4 | eth-0-4 | 0         | N/A            | 1          | 2016/09/05,07:13:24 |

=====
Instance states in the member interfaces:
  A - ACTIVE , B -BLOCK , D-The interface is link-down
Map-instance-ID P1(eth-0-1 ) P2(eth-0-2 ) P3(eth-0-3 ) P4(eth-0-4 )
1                A                B                B                B
2                B                A                B                B
3                B                B                A                B
4                B                B                B                A
```

Display the result on Switch2-5.

```
Switch# show multi-link
Relay multi-link flush packet is enabled
Multi-link flush receiver interface:
  eth-0-13 control-vlan:10 password:test
Multi-link received flush packet number:0
Multi-link processed flush packet number:0
Multi-link tcn is disabled
Multi-link tcn query count      2
Multi-link tcn query interval :10
Multi-link Group Number is 0.
```

16.10.3 Application cases

Configuring Multi-Link Enhance

There is an enhanced method to improve the ability of multi-link to protect link. When all the interfaces of multi-link group are down, you can enable another interface to send the enhance packet to peer which makes the instance state of one interface to change from block to active. It would avoid the switch being the state of islet.

When 2 multi-link group on different switches backup for each other, multi-link members on one switch is blocked and can not protect the traffic.

In this example:

- Core switch A and B, Access switch A and B, make up a full-match topology.
- Enable multi-link on Access switch A, the priority for link a/b/c is 1/2/3.
- Enable multi-link on Access switch B, the priority for link d/e is 1/2.

In normal condition, link b/c/e are block, link a/d are active. As the following figure shows:

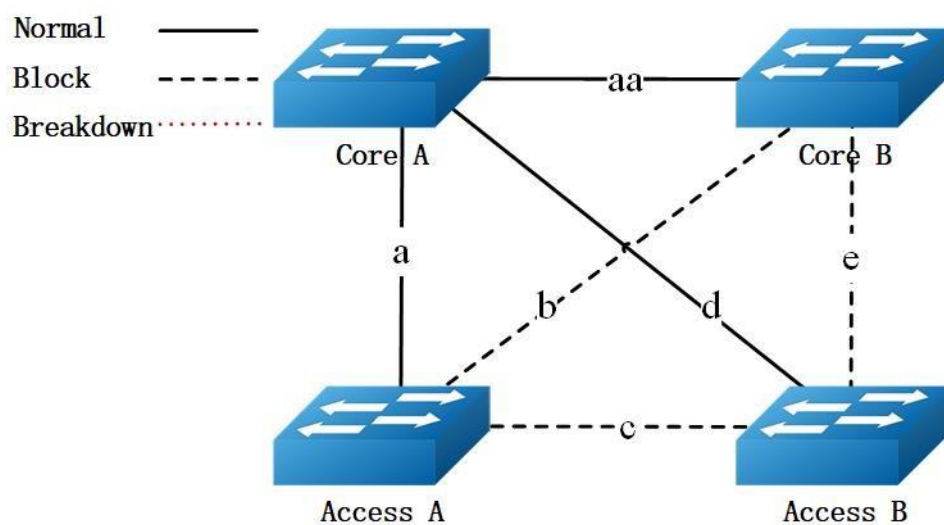

When link d/e are break down, the only out going link for Access switch B is link c, which is between Access switch A and Access switch B.

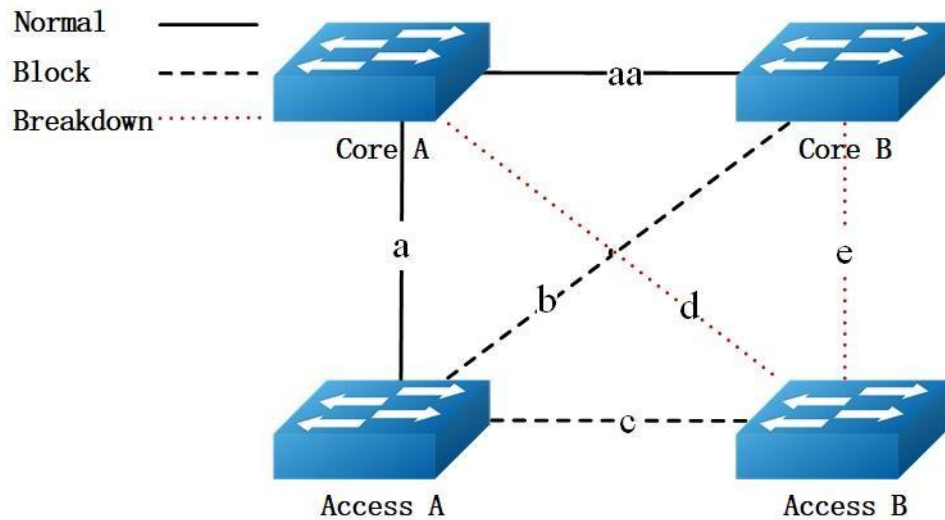

Because link c is blocked, the Access switch B is the state of islet. As the following figure shows:

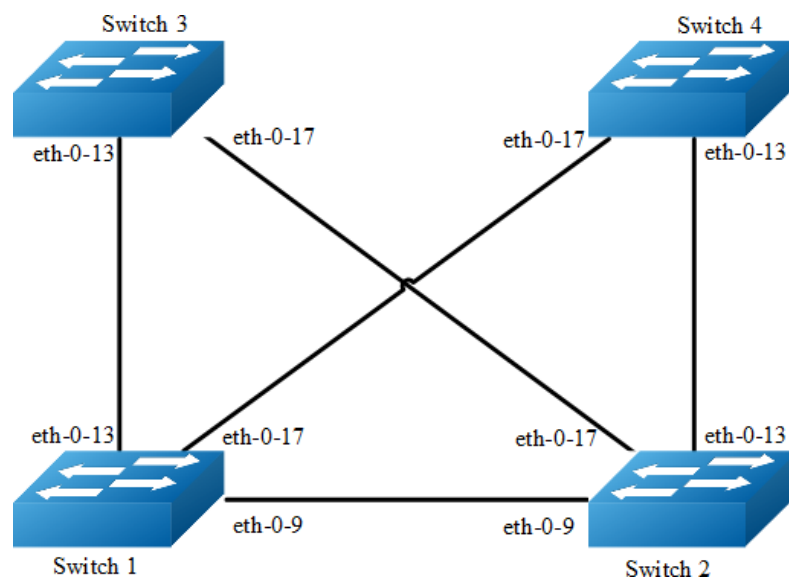

Figure 16-19 Multilink-enhance Typical Topology

The figure above is a typical multi-link application. The Switch1, 2 are configured multi-link group. Switch1 has the interface which receives the multilink-enhance packets. And , Switch2 has the interface which sends the multilink-enhance packets.

To configure multi-link group, some configuration should be configured before it.

- VLANs should be configured.
- MSTP instance should be configured.
- Spanning-tree should be disabled in the interface.

- About above configurations, please see the related references.
- It should configure the control vlan and password of flush sending before setting the multilink-enhance interface.

The following configuration should be operated on all switches if the switch ID is not specified.

step 1 Enter the configure mode

```
Switch# configure terminal
```

step 2 Enter the vlan configure mode and create the vlan

```
Switch(config)# vlan database
Switch(config-vlan)# vlan 10
Switch(config-vlan)# vlan 20
Switch(config-vlan)# vlan 30
Switch(config-vlan)# vlan 40
Switch(config-vlan)# exit
```

step 3 Set the spanning tree mode and create mstp instance

```
Switch(config)# spanning-tree mode mstp
Switch(config)# spanning-tree mst configuration
Switch(config-mst)# instance 1 vlan 10
Switch(config-mst)# instance 1 vlan 30
Switch(config-mst)# instance 2 vlan 20
Switch(config-mst)# instance 2 vlan 40
Switch(config-mst)# exit
```

step 4 Enter the interface configure mode and set the attributes of the interface

Interface configuration for Switch1:

```
Switch1(config)# interface range eth-0-9
Switch1(config-if)# switchport mode trunk
Switch1(config-if)# switchport trunk allowed vlan all
Switch1(config-if)# spanning-tree port disable
Switch1(config-if)# no shutdown
Switch1(config-if)# exit

Switch1(config)# interface range eth-0-13
Switch1(config-if)# switchport mode trunk
Switch1(config-if)# switchport trunk allowed vlan all
Switch1(config-if)# spanning-tree port disable
Switch1(config-if)# no shutdown
Switch1(config-if)# exit

Switch1(config)# interface range eth-0-17
```

```
Switch1(config-if)# switchport mode trunk
Switch1(config-if)# switchport trunk allowed vlan all
Switch1(config-if)# spanning-tree port disable
Switch1(config-if)# no shutdown
Switch1(config-if)# exit
```

Interface configuration for Switch2:

```
Switch(config)# interface eth-0-13
Switch(config-if)# switchport mode trunk
Switch(config-if)# switchport trunk allowed vlan all
Switch(config-if)# no shutdown
Switch(config-if)# exit

Switch(config)# interface eth-0-17
Switch(config-if)# switchport mode trunk
Switch(config-if)# switchport trunk allowed vlan all
Switch(config-if)# no shutdown
Switch(config-if)# exit

Switch(config)# interface eth-0-9
Switch(config-if)# multi-link flush receive control-vlan 30 password simple a
Switch(config-if)#exit
```

Interface configuration for Switch3:

```
Switch(config)# interface eth-0-13
Switch(config-if)# multi-link flush receive control-vlan 30 password simple a
Switch(config-if)#exit

Switch(config)# interface eth-0-17
Switch(config-if)# multi-link flush receive control-vlan 30 password simple b
Switch(config-if)#exit
```

Interface configuration for Switch4:

```
Switch(config)# interface eth-0-13
Switch(config-if)# multi-link flush receive control-vlan 30 password simple b
Switch(config-if)#exit

Switch(config)# interface eth-0-17
Switch(config-if)# multi-link flush receive control-vlan 30 password simple a
Switch(config-if)#exit
```

step 5 Create multi link group and set the attributes of the group

Create multi link group on Switch1:

```
Switch(config)# multi-link group 1
Switch(config-multilink-group)# interface eth-0-13 priority 1
Switch(config-multilink-group)# interface eth-0-17 priority 2
Switch(config-multilink-group)# interface eth-0-9 priority 3
Switch(config-multilink-group)# protected mstp instance 1
Switch(config-multilink-group)# protected mstp instance 2
Switch(config-multilink-group)# flush send control-vlan 30 password simple a
```

```
Switch(config-multilink-group)# multilink-enhance receive control-vlan 10 password b
interface eth-0-9
Switch(config-multilink-group)# group enable
Switch(config-multilink-group)# end
```

Create multi link group on Switch2:

```
Switch(config)# multi-link group 1
Switch(config-multilink-group)# interface eth-0-13 priority 1
Switch(config-multilink-group)# interface eth-0-17 priority 2
Switch(config-multilink-group)# protected mstp instance 1
Switch(config-multilink-group)# protected mstp instance 2
Switch(config-multilink-group)# flush send control-vlan 10 password simple b
Switch(config-multilink-group)# multilink-enhance interface eth-0-9
Switch(config-multilink-group)# group enable
Switch(config-multilink-group)# exit
```

step 6 Exit the configure mode

```
Switch(config)# end
```

step 7 Validation

Display the result on Switch1.

```
Switch1# show multi-link group 1
Multi-link group 1 information:
The multi-link group was enabled.
=====
Auto-restore:
state      time      count     Last-time
disabled   60        0         N/A
=====
Protected instance: 1 2
Load balance instance:
Flush sender , Control-vlan ID: 30   Password: a
=====
INTERFACE:
Role  Member   DownCount  Last-Down-Time      FlushCount  Last-Flush-Time
PRI1  eth-0-13  0          N/A                 5           2017/05/15,07:50:11
PRI2  eth-0-17  0          N/A                 0           N/A
PRI3  eth-0-9   1          2017/05/15,07:48:46 5           2017/05/15,07:50:11
PRI4  N/A       0          N/A                 0           N/A
=====
Instance states in the member interfaces:
A-ACTIVE , B-BLOCK , A(E)-ENHANCE_ACTIVE D-The interface is link-down
Map-instance-ID P1(eth-0-13) P2(eth-0-17) P3(eth-0-9) P4(N/A)
1 A B B D
2 A B B D

Switch# show multi-link
Relay multi-link flush packet is enabled
Multi-link enhance receiver interface:
eth-0-9 control-vlan:10 password:b
```

```

Multi-link received flush packet number : 0
Multi-link processed flush packet number: 0
Multi-link received enhance packet number : 4
Multi-link processed enhance packet number: 4
Multi-link tcn is disabled
Multi-link tcn query count      : 2
Multi-link tcn query interval : 10
Multi-link Group Number is 1.
  Group-ID   State      Pri-1      Pri-2      Pri-3      Pri-4
  1          enabled   eth-0-13  eth-0-17  eth-0-9    N/A

```

Display the result on Switch2.

```

Switch# show multi-link group1
Multi-link group 1 information:
The multi-link group was enabled.
=====
Auto-restore:
  state      time      count      Last-time
  disabled   60        0          N/A
=====
Protected instance: 1 2
Load balance instance:
Flush sender , Control-vlan ID: 10 Password: b
Multilink enhance interface: eth-0-9, Control-vlan ID: 10 Password: b
=====
INTERFACE:
Role  Member   DownCount Last-Down-Time      FlushCount Last-Flush-Time
PRI1  eth-0-13  1         2017/05/15,07:49:15 0          N/A
PRI2  eth-0-17  2         2017/05/15,07:50:03 3          2017/05/15,07:50:11
PRI3  N/A       0         N/A                 0          N/A
PRI4  N/A       0         N/A                 0          N/A
=====
ENHANCE INTERFACE:
Role  Member   DownCount Last-Down-Time      EnhanceCount Last-SendEnhance-Ti
me
M-En  eth-0-9  0         N/A                 0          N/A
=====
Instance states in the member interfaces:
  A-ACTIVE , B-BLOCK , A(E)-ENHANCE_ACTIVE D-The interface is link-down
Map-instance-ID P1(eth-0-13) P2(eth-0-17) P3(N/A) P4(N/A)
1              A          B          D          D
2              A          B          D          D

Switch# show multi-link
Relay multi-link flush packet is enabled
Multi-link received flush packet number : 0
Multi-link processed flush packet number: 0
Multi-link received enhance packet number : 0
Multi-link processed enhance packet number: 0
Multi-link tcn is disabled
Multi-link tcn query count      : 2
Multi-link tcn query interval : 10
Multi-link Group Number is 1.

```

Group-ID	State	Pri-1	Pri-2	Pri-3	Pri-4
1	enabled	eth-0-13	eth-0-17	N/A	N/A

16.11 Configuring Monitor Link

16.11.1 Overview

Function Introduction

Monitor Link is a port collaboration function. Monitor Link usually works together with Layer 2 topology protocols. The idea is to monitor the states of uplink ports and adapt the up/down state of downlink ports to the up/down state of uplink ports, triggering link switchover on the downstream switch in time.

Principle Description

N/A

16.11.2 Configuration

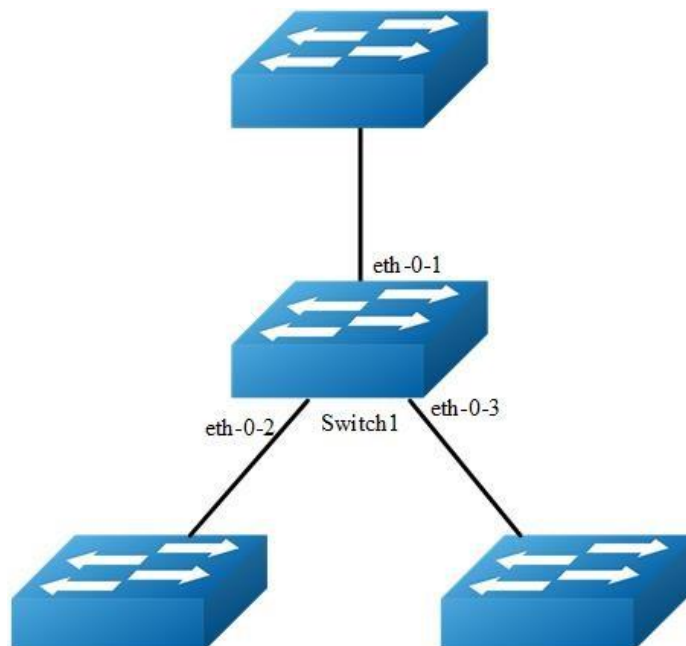

Figure 16-20 monitor link

step 1 Enter the configure mode

```
Switch# configure terminal
```

step 2 Enter the interface configure mode and turn on the interface

```
Switch(config)# interface range eth-0-1 - 3
Switch(config-if-range)# no shutdown
Switch(config-if-range)# exit
```

step 3 Create multi link group and set the attributes of the group

```
Switch(config)# monitor-link group 1
Switch(config-mtlk-group)# monitor-link uplink interface eth-0-1
Switch(config-mtlk-group)# monitor-link downlink interface eth-0-2
Switch(config-mtlk-group)# monitor-link downlink interface eth-0-3
Switch(config-mtlk-group)# exit
```

step 4 Exit the configure mode

```
Switch(config)# end
```

step 5 Validation

```
Switch# show monitor-link group
Group Id: 1
Monitor link status: UP
```

Role	Member	Last-up-time	Last-down-time	upcount	downcount
UpLk 1	eth-0-1	2011/07/15,02:07:31	2011/07/15,02:07:31	2	1
DwLk 1	eth-0-2	2011/07/15,02:07:34	2011/07/15,02:07:31	1	1
DwLk 2	eth-0-3	N/A	N/A	0	0

16.11.3 Application cases

N/A

16.12 Configuring VRRP

16.12.1 Overview

Function Introduction

This chapter provides an overview of Virtual Router Redundancy Protocol (VRRP) and its implementation. VRRP eliminates the risk of a single point of failure inherent in

a static default routing environment. It specifies an election protocol that dynamically assigns responsibility for a virtual router to one of the VRRP routers on a LAN. One of the major advantages of VRRP is that it makes default path available without requiring configuration of dynamic routing on every end-host.

**NOTE**

MD5 authentication is not yet supported for VRRP.

Principle Description

The VRRP module is based on: RFC 3768 (VRRP): Knight, S., et.al "Virtual Router Redundancy Protocol (VRRP)"

Terminology

- **Backup Router:** VRRP router that back up an IP address. It assumes forwarding responsibility for the virtual IP address if the Master fails.
- **Critical IP:** The IP address that the VRRP router send/receive messages on for a particular session.
- **IP Address Owner:** The VRRP Router that has the virtual router's IP address (es) as real interface address (es). This is the router that, when up, will respond to packets addressed to one of these IP addresses for ICMP pings, TCP connections, etc.
- **Master Router:** The VRRP router that owns the IP address (i.e., is being backed up), and which is the default router for forwarding for that IP address.
- **Virtual IP:** The IP address back up by a VRRP session.
- **Virtual Router:** A router managed by VRRP that acts as a default router for hosts on a shared LAN. It consists of a Virtual Router Identifier and a set of associated IP addresses across a common LAN. A VRRP Router might backup one or more virtual routers.
- **VRRP Router:** A router runs the Virtual Router Redundancy Protocol. It might participate in one or more virtual routers.

Typically, end hosts are connected to the enterprise network through a single router (first hop router) that is in the same Local Area Network (LAN) segment. The most popular method of configuration for the end hosts is to statically configure this router as their default gateway. This minimizes configuration and processing overhead. The

main problem with this configuration method is that it produces a single point of failure if this first hop router fails.

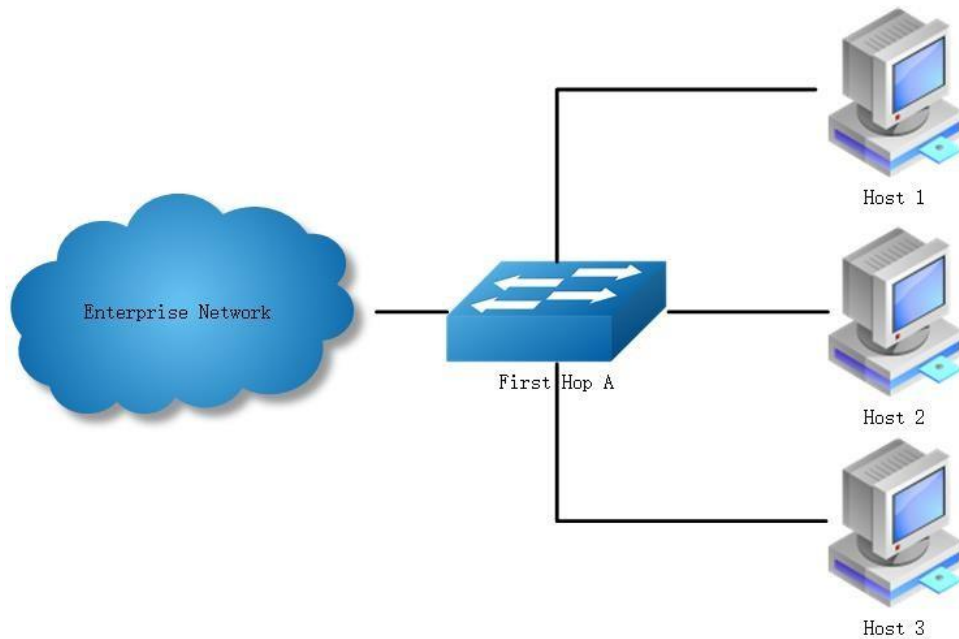

Figure 16-21 Without VRRP

The Virtual Router Redundancy Protocol attempts to solve this problem by introducing the concept of a virtual router, composed of two or more VRRP routers on the same subnet. The concept of a virtual IP address is also introduced, which is the address that end hosts configure as their default gateway. Only one router (called the master) forward packets on the behalf of this IP address. In the event that the Master router fails, one of the other routers (Backup) assumes forwarding responsibility for it.

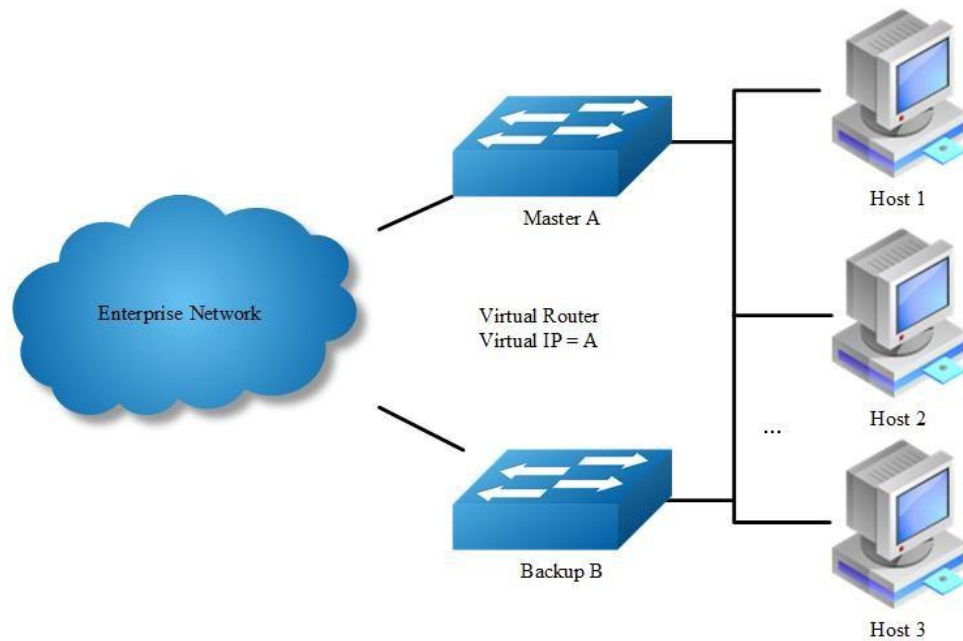

Figure 16-22 With VRRP

At first glance, the configuration outlined in might not seem very useful, as it doubles the cost and leaves one router idle at all times. This, however, can be avoided by creating two virtual routers and splitting the traffic between them.

16.12.2 Configuration

Configuring VRRP (One Virtual Router)

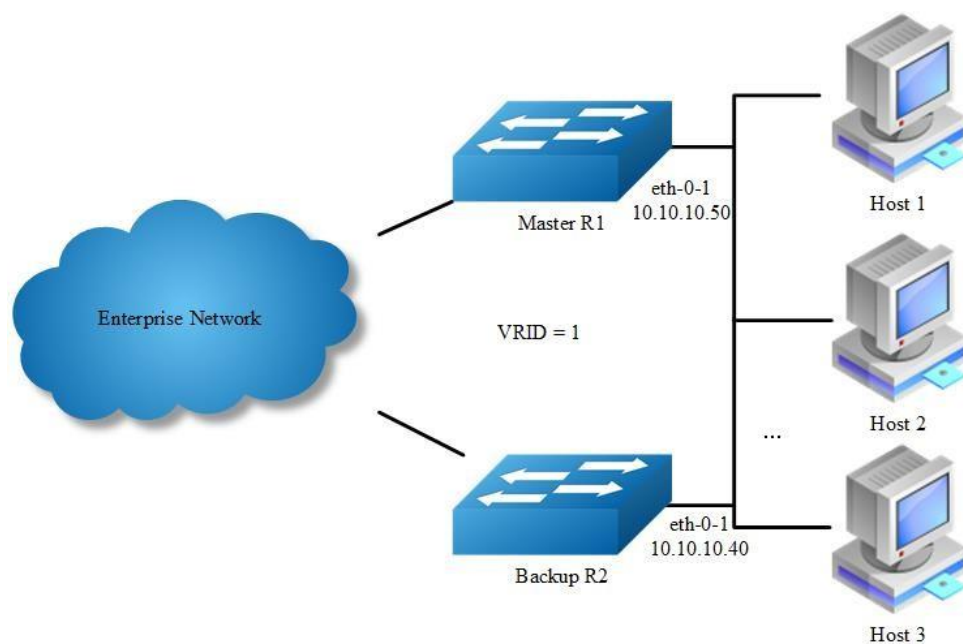

Figure 16-23 VRRP with one virtual router

In this configuration the end-hosts install a default route to the IP address of virtual router 1 (VRID = 1) and both routers R1 and R2 run VRRP. R1 is configured to be the Master for virtual router 1 (VRID = 1) and R2 as a Backup for virtual router 1. If R1 fails, R2 will take over virtual router 1 and its IP addresses, and provide uninterrupted service for the hosts. Configuring only one virtual router, doubles the cost and leaves R2 idle at all times.

The following configuration should be operated on all devices if the device ID is not specified.

step 1 Enter the configure mode

```
Switch# configure terminal
```

step 2 Enter the interface configure mode and set the attributes of the interface

Interface configuration for R1:

```
Switch(config)# interface eth-0-1
Switch(config-if)# no switchport
Switch(config-if)# ip address 10.10.10.50/24
Switch(config-if)# no shutdown
Switch(config-if)# exit
```

Interface configuration for R2:

```
Switch(config)# interface eth-0-1
Switch(config-if)# no switchport
Switch(config-if)# ip address 10.10.10.40/24
Switch(config-if)# no shutdown
Switch(config-if)# exit
```

step 3 Create an instance of vrrp

```
Switch(config)# router vrrp 1
Switch(config-router)# virtual-ip 10.10.10.60
Switch(config-router)# interface eth-0-1
Switch(config-router)# preempt-mode true
Switch(config-router)# advertisement-interval 5
```

step 4 Set the priority (optional)

Set the priority on R1. R1 use the default value if the priority is not configured.

```
Switch(config-router)# priority 200
```

step 5 Enable vrrp and Exit the vrrp configure mode

```
Switch(config-router)# enable
Switch(config-router)# exit
```

step 6 Exit the configure mode

```
Switch(config)# end
```

step 7 Validation

Display the result on R1.

```
Switch# show vrrp
vrrp session count: 1
vrrp version      : 2
VRID <1>
  State           : Master
  Virtual IP      : 10.10.10.60 (Not IP owner)
  Interface       : eth-0-1
  VMAC            : 0000.5e00.0101
  VRF              : Default
  Uniform-mac     : -
  Advt timer      : 5 second(s)
  Preempt mode    : TRUE
  Conf pri        : 200           Run pri   : 200
  Master router ip : 10.10.10.50
  Master priority  : 200
  Master advt timer : 5 second(s)
  Master down timer : 15 second(s)
  Preempt delay   : 0 second(s)
  Learn master mode : FALSE
```

Display the result on R2.

```
Switch# show vrrp
vrrp session count: 1
vrrp version      : 2
VRID <1>
  State           : Backup
  Virtual IP      : 10.10.10.60 (Not IP owner)
  Interface       : eth-0-1
  VMAC            : 0000.5e00.0101
  VRF              : Default
  Uniform-mac     : -
  Advt timer      : 5 second(s)
  Preempt mode    : TRUE
  Conf pri        : 100           Run pri   : 100
  Master router ip : 10.10.10.50
  Master priority  : 200
  Master advt timer : 5 second(s)
  Master down timer : 16 second(s)
```

```
Preempt delay      : 0 second(s)
Learn master mode  : FALSE
```

Configuring VRRP (Two Virtual Router)

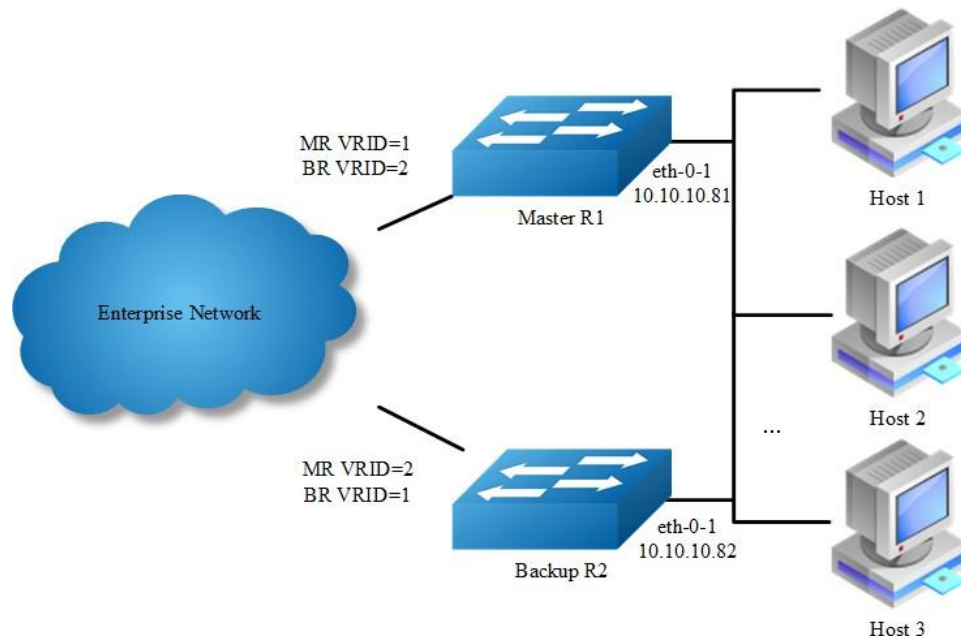

Figure 16-24 VRRP with two virtual router

In the one virtual router example earlier, R2 is not backed up by R1. This example illustrates how to backup R2 by configuring a second virtual router.

In this configuration, R1 and R2 are two virtual routers and the hosts split their traffic between R1 and R2. R1 and R2 function as backups for each other.

The following configuration should be operated on all devices if the device ID is not specified.

step 1 Enter the configure mode

```
Switch# configure terminal
```

step 2 Enter the interface configure mode and set the attributes of the interface

Interface configuration for R1:

```
Switch(config)# interface eth-0-1
Switch(config-if)# no switchport
Switch(config-if)# ip address 10.10.10.81/24
```

```
Switch(config-if) # no shutdown
Switch(config-if) # exit
```

Interface configuration for R2:

```
Switch(config) # interface eth-0-1
Switch(config-if) # no switchport
Switch(config-if) # ip address 10.10.10.82/24
Switch(config-if) # no shutdown
Switch(config-if) # exit
```

step 3 Create an instance of vrrp

Configuring R1:

```
Switch(config) # router vrrp 1
Switch(config-router) # virtual-ip 10.10.10.81
Switch(config-router) # interface eth-0-1
Switch(config-router) # preempt-mode true
Switch(config-router) # advertisement-interval 5
Switch(config-router) # enable
Switch(config-router) # exit

Switch(config) # router vrrp 2
Switch(config-router) # virtual-ip 10.10.10.82
Switch(config-router) # interface eth-0-1
Switch(config-router) # priority 200
Switch(config-router) # preempt-mode true
Switch(config-router) # advertisement-interval 5
Switch(config-router) # enable
Switch(config-router) # exit
```

Configuring R2:

```
Switch(config) # router vrrp 1
Switch(config-router) # virtual-ip 10.10.10.81
Switch(config-router) # interface eth-0-1
Switch(config-router) # priority 200
Switch(config-router) # preempt-mode true
Switch(config-router) # advertisement-interval 5
Switch(config-router) # enable
Switch(config-router) # exit

Switch(config) # router vrrp 2
Switch(config-router) # virtual-ip 10.10.10.82
Switch(config-router) # interface eth-0-1
Switch(config-router) # preempt-mode true
Switch(config-router) # advertisement-interval 5
Switch(config-router) # enable
Switch(config-router) # exit
```

step 4 Exit the configure mode

```
Switch(config) # end
```

step 5 Validation

Display the result on R1.

```
Switch# show vrrp
vrrp session count: 2
vrrp version      : 2
VRID <1>
  State           : Master
  Virtual IP      : 10.10.10.81 (IP owner)
  Interface       : eth-0-9
  VMAC            : 0000.5e00.0101
  VRF             : Default
  Uniform-mac     : -
  Advt timer      : 5 second(s)
  Preempt mode    : TRUE
  Conf pri        : 100           Run pri   : 255
  Master router ip : 10.10.10.81
  Master priority : 255
  Master advt timer : 5 second(s)
  Master down timer : 15 second(s)
  Preempt delay   : 0 second(s)
  Learn master mode : FALSE
VRID <2>
  State           : Backup
  Virtual IP      : 10.10.10.82 (Not IP owner)
  Interface       : eth-0-9
  VMAC            : 0000.5e00.0102
  VRF             : Default
  Uniform-mac     : -
  Advt timer      : 5 second(s)
  Preempt mode    : TRUE
  Conf pri        : 200           Run pri   : 200
  Master router ip : 10.10.10.82
  Master priority : 255
  Master advt timer : 5 second(s)
  Master down timer : 15 second(s)
  Preempt delay   : 0 second(s)
  Learn master mode : FALSE
```

Display the result on R2.

```
Switch# show vrrp
vrrp session count: 2
vrrp version      : 2
VRID <1>
  State           : Backup
  Virtual IP      : 10.10.10.81 (Not IP owner)
  Interface       : eth-0-9
  VMAC            : 0000.5e00.0101
  VRF             : Default
  Uniform-mac     : -
  Advt timer      : 5 second(s)
  Preempt mode    : TRUE
  Conf pri        : 200           Run pri   : 200
```

```

Master router ip    : 10.10.10.81
Master priority     : 255
Master advt timer   : 5 second(s)
Master down timer   : 15 second(s)
Preempt delay       : 0 second(s)
Learn master mode   : FALSE
VRID <2>
State               : Master
Virtual IP          : 10.10.10.82(IP owner)
Interface           : eth-0-9
VMAC                : 0000.5e00.0102
VRF                 : Default
Uniform-mac         : -
Advt timer          : 5 second(s)
Preempt mode        : TRUE
Conf pri            : 100           Run pri    : 255
Master router ip    : 10.10.10.82
Master priority     : 255
Master advt timer   : 5 second(s)
Master down timer   : 15 second(s)
Preempt delay       : 0 second(s)
Learn master mode   : FALSE

```

VRRP Circuit Failover

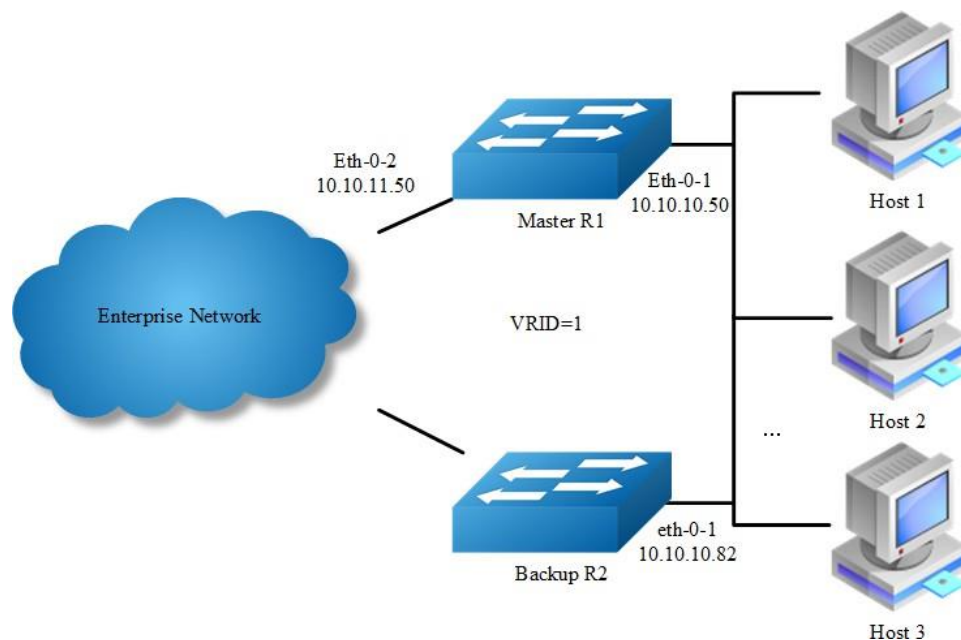

Figure 16-25 VRRP Circuit Failover

The need for VRRP Circuit Failover arose because VRRPv2 was unable to track the gateway interface status. The VRRP Circuit Failover feature provides a dynamic failover of an entire circuit in the event that one member of the group fails. It introduces the concept of a circuit, where two or more Virtual Routers on a single

system can be grouped. In the event that a failure occurs and one of the Virtual Routers performs the Master to Backup transition, the other Virtual Routers in the group are notified and are forced into the Master to Backup transition, so that both incoming and outgoing packets are routed through the same gateway router, eliminating the problem for Firewall/NAT environments. The following scenario explains this feature.

To configure VRRP Circuit Failover, each circuit is configured to have a corresponding priority-delta value, which is passed to VRRP when a failure occurs. The priority of each Virtual Router on the circuit is decremented by the priority delta value causing the VR Master to VR Backup transition.

In this example, two routers R1 and R2 are configured as backup routers with different priorities. The priority-delta value is configured to be greater than the difference of both the priorities. R1 is configured to have a priority of 100 and R2 has a priority of 90. R1 with a greater priority is the Virtual Router Master. The priority-delta value is 20, greater than 10 (100 minus 90). On R1 when the external interface eth1 fails, the priority of R1 becomes 80 (100 minus 20). Since R2 has a greater priority (90) than R1, R2 becomes the VR Master and routing of packages continues without interruption.

When this VR Backup (R1) is up again, it regains its original priority (100) and becomes the VR Master again.

The following configuration should be operated on all devices if the device ID is not specified.

step 1 Enter the configure mode

```
Switch# configure terminal
```

step 2 Enter the interface configure mode and set the attributes of the interface

Interface configuration for R1:

```
Switch(config)# interface eth-0-1
Switch(config-if)# no switchport
Switch(config-if)# ip address 10.10.10.50/24
Switch(config-if)# no shutdown
Switch(config-if)# exit

Switch(config)# interface eth-0-2
Switch(config-if)# no switchport
```

```
Switch(config-if)# ip address 10.10.11.50/24
Switch(config-if)# no shutdown
Switch(config-if)# exit
```

Interface configuration for R2:

```
Switch(config)# interface eth-0-1
Switch(config-if)# no switchport
Switch(config-if)# ip address 10.10.10.40/24
Switch(config-if)# no shutdown
Switch(config-if)# exit
```

step 3 Create an track object to monitor the link state

Configuring R1:

```
Switch(config)# track 10 interface eth-0-2 linkstate
```

To get more information about track, please reference to the "Configuring Track" chapter.

step 4 Create an instance of vrrp

Configuring R1:

```
Switch(config)# router vrrp 1
Switch(config-router)# virtual-ip 10.10.10.1
Switch(config-router)# interface eth-0-1
Switch(config-router)# preempt-mode true
Switch(config-router)# advertisement-interval 5
Switch(config-router)# priority 100
Switch(config-router)# track 10 decrement 20
Switch(config-router)# enable
```

Configuring R2:

```
Switch(config)# router vrrp 1
Switch(config-router)# virtual-ip 10.10.10.1
Switch(config-router)# interface eth-0-1
Switch(config-router)# preempt-mode true
Switch(config-router)# advertisement-interval 5
Switch(config-router)# priority 90
Switch(config-router)# enable
```

step 5 Exit the configure mode

```
Switch(config)# end
```

step 6 Validation

Display the result on R1.

```
Switch# show vrrp
vrrp session count: 1
vrrp version      : 2
VRID <1>
  State           : Master
  Virtual IP      : 10.10.10.1 (Not IP owner)
  Interface       : eth-0-9
  VMAC            : 0000.5e00.0101
  VRF             : Default
  Uniform-mac     : -
  Advt timer      : 5 second(s)
  Preempt mode    : TRUE
  Conf pri        : 100          Run pri   : 100
  Track Object    : 10          Decre pri : 20
  Decre pri       : 20
  Master router ip : 10.10.10.50
  Master priority  : 100
  Master advt timer : 5 second(s)
  Master down timer : 16 second(s)
  Preempt delay    : 0 second(s)
  Learn master mode : FALSE
```

Display the result on R2.

```
Switch# show vrrp
vrrp session count: 1
vrrp version      : 2
VRID <1>
  State           : Backup
  Virtual IP      : 10.10.10.1 (Not IP owner)
  Interface       : eth-0-9
  VMAC            : 0000.5e00.0101
  VRF             : Default
  Uniform-mac     : -
  Advt timer      : 5 second(s)
  Preempt mode    : TRUE
  Conf pri        : 90          Run pri   : 90
  Master router ip : 10.10.10.50
  Master priority  : 100
  Master advt timer : 5 second(s)
  Master down timer : 16 second(s)
  Preempt delay    : 0 second(s)
  Learn master mode : FALSE
```

Configuring IPv6 VRRP(One Virtual Router)

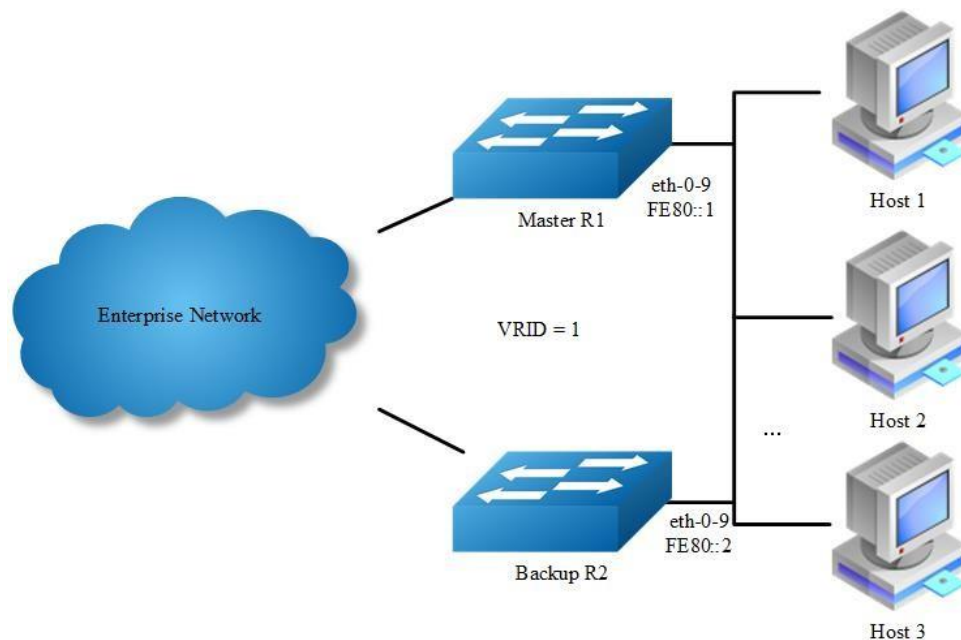

Figure 16-26 IPv6 VRRP with one virtual router

In this configuration the end-hosts install a default route to the IP address of virtual router 1 (VRID = 1) and both routers R1 and R2 run VRRP. R1 is configured to be the Master for virtual router 1 (VRID = 1) and R2 as a Backup for virtual router 1. If R1 fails, R2 will take over virtual router 1 and its IP addresses, and provide uninterrupted service for the hosts. Configuring only one virtual router, doubles the cost and leaves R2 idle at all times.

The following configuration should be operated on all devices if the device ID is not specified.

step 1 Enter the configure mode and enable IPv6

```
Switch# configure terminal
Switch(config)# ipv6 enable
```

step 2 Enter the interface configure mode and set the attributes of the interface

Interface configuration for R1:

```
Switch(config)# interface eth-0-9
Switch(config-if)# no switchport
Switch(config-if)# ipv6 address fe80::1 link-local
```

```
Switch(config-if)# no shutdown
Switch(config-if)# exit
```

Interface configuration for R2:

```
Switch(config)# interface eth-0-9
Switch(config-if)# no switchport
Switch(config-if)# ipv6 address fe80::2 link-local
Switch(config-if)# no shutdown
Switch(config-if)# exit
```

step 3 Create an instance of IPv6 VRRP

```
Switch(config)# router ipv6 vrrp 1
Switch(config-router)# virtual-ipv6 fe80::1 link-local
Switch(config-router)# interface eth-0-9
```

step 4 Set the priority (optional)

Set the priority on R1. R2 use the default value 100 if the priority is not configured.

```
Switch(config-router)# priority 200
```

step 5 Enable IPv6 VRRP and Exit the router configure mode

```
Switch(config-router)# enable
Switch(config-router)# exit
```

step 6 Exit the configure mode

```
Switch(config)# end
```

step 7 Validation

Display the result on R1.

```
Switch# show ipv6 vrrp 1
VRID <1>
  State           : Master
  Virtual IP      : fe80::1(IP owner)
  Interface       : eth-0-9
  VMAC            : 0000.5e00.0201
  VRF              : Default
  Advt timer      : 1 second(s)
  Preempt mode    : TRUE
  Conf pri        : 200           Run pri   : 255
  Master router ip : fe80::1
  Master priority  : 255
  Master advt timer : 100 centi-second(s)
  Master down timer : 3 second(s)
  Preempt delay    : 0 second(s)
```

Display the result on R2.

```
Switch# show ipv6 vrrp 1
VRID <1>
State           : Backup
Virtual IP      : fe80::1 (Not IP owner)
Interface       : eth-0-9
VMAC           : 0000.5e00.0201
VRF            : Default
Advt timer     : 1 second(s)
Preempt mode   : TRUE
Conf pri       : 100           Run pri   : 100
Master router ip : fe80::1
Master priority : 255
Master advt timer : 100 centi-second(s)
Master down timer : 4 second(s)
Preempt delay  : 0 second(s)
```

Configuring IPv6 VRRP (Two Virtual Router)

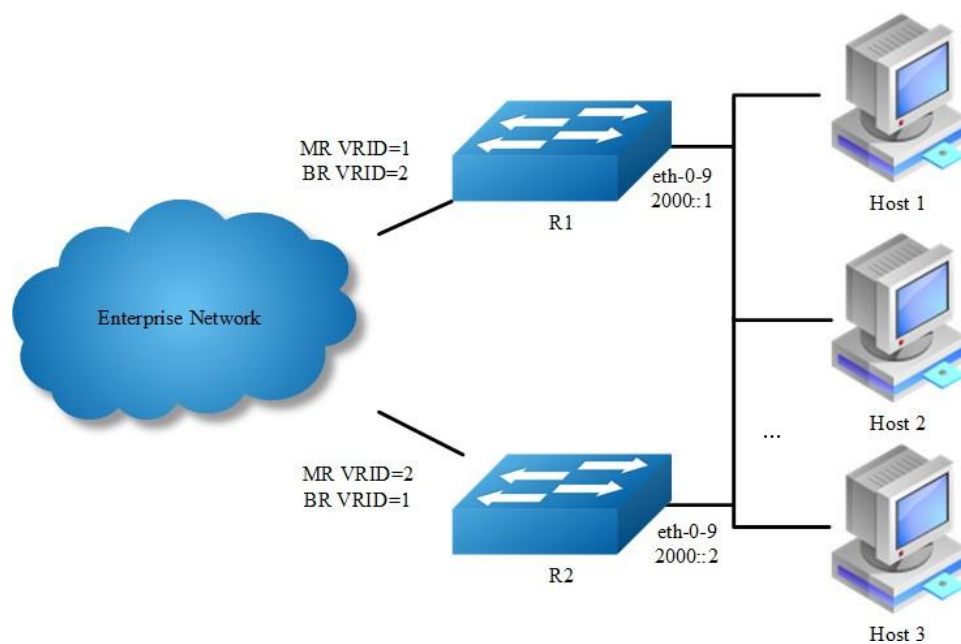

Figure 16-27 IPv6 VRRP with two virtual router

In the one virtual router example earlier, R2 is not backed up by R1. This example illustrates how to backup R2 by configuring a second virtual router.

In this configuration, R1 and R2 are two virtual routers and the hosts split their traffic between R1 and R2. R1 and R2 function as backups for each other.

The following configuration should be operated on all devices if the device ID is not specified.

step 1 Enter the configure mode and enable IPv6

```
Switch# configure terminal
Switch(config)# ipv6 enable
```

step 2 Enter the interface configure mode and set the attributes of the interface

Interface configuration for R1:

```
Switch(config)# interface eth-0-9
Switch(config-if)# no switchport
Switch(config-if)# ipv6 address 2000::1/64
Switch(config-if)# no shutdown
Switch(config-if)# exit
```

Interface configuration for R2:

```
Switch(config)# interface eth-0-9
Switch(config-if)# no switchport
Switch(config-if)# ipv6 address 2000::2/64
Switch(config-if)# no shutdown
Switch(config-if)# exit
```

step 3 Create an instance of IPv6 VRRP

Configuring R1:

```
Switch(config)# router ipv6 vrrp 1
Switch(config-router)# interface eth-0-9
Switch(config-router)# priority 200
Switch(config-router)# virtual-ipv6 fe80::1 link-local
Switch(config-router)# virtual-ipv6 2000::1
Switch(config-router)# enable
Switch(config-router)# exit

Switch(config)# router ipv6 vrrp 2
Switch(config-router)# interface eth-0-9
Switch(config-router)# virtual-ipv6 fe80::3 link-local
Switch(config-router)# virtual-ipv6 2000::2
Switch(config-router)# enable
Switch(config-router)# exit
```

Configuring R2:

```
Switch(config)# router ipv6 vrrp 1
Switch(config-router)# interface eth-0-9
Switch(config-router)# virtual-ipv6 fe80::1 link-local
Switch(config-router)# virtual-ipv6 2000::1
Switch(config-router)# enable
Switch(config-router)# exit

Switch(config)# router vrrp 2
Switch(config-router)# interface eth-0-9
```

```
Switch(config-router)# priority 200
Switch(config-router)# virtual-ipv6 fe80::3 link-local
Switch(config-router)# virtual-ipv6 2000::2
Switch(config-router)# enable
Switch(config-router)# exit
```

step 4 Exit the configure mode

```
Switch(config)# end
```

step 5 Validation

Display the result on R1.

```
Switch# show ipv6 vrrp
IPv6 vrrp session count: 2
VRID <1>
  State           : Master
  Virtual IP      : fe80::1 (Not IP owner)
                  2000::1 (IP owner)
  Interface       : eth-0-9
  VMAC            : 0000.5e00.0201
  VRF             : Default
  Advt timer      : 1 second(s)
  Preempt mode    : TRUE
  Conf pri        : 200           Run pri   : 255
  Master router ip : fe80::48cc:69ff:fec8:5b00
  Master priority  : 255
  Master advt timer : 100 centi-second(s)
  Master down timer : 3 second(s)
  Preempt delay    : 0 second(s)
VRID <2>
  State           : Backup
  Virtual IP      : fe80::3 (Not IP owner)
                  2000::2 (Not IP owner)
  Interface       : eth-0-9
  VMAC            : 0000.5e00.0202
  VRF             : Default
  Advt timer      : 1 second(s)
  Preempt mode    : TRUE
  Conf pri        : 100           Run pri   : 100
  Master router ip : fe80::b002:86ff:febc:3700
  Master priority  : 255
  Master advt timer : 100 centi-second(s)
  Master down timer : 4 second(s)
  Preempt delay    : 0 second(s)
```

Display the result on R2.

```
Switch# show ipv6 vrrp
IPv6 vrrp session count: 2
VRID <1>
  State           : Backup
  Virtual IP      : fe80::1 (Not IP owner)
```

```

2000::1(Not IP owner)
Interface      : eth-0-9
VMAC          : 0000.5e00.0201
VRF           : Default
Advt timer    : 1 second(s)
Preempt mode  : TRUE
Conf pri      : 100          Run pri   : 100
Master router ip : fe80::48cc:69ff:fec8:5b00
Master priority : 255
Master advt timer : 100 centi-second(s)
Master down timer : 4 second(s)
Preempt delay  : 0 second(s)
VRID <2>
State         : Master
Virtual IP    : fe80::3(Not IP owner)
              2000::2(IP owner)
Interface     : eth-0-9
VMAC         : 0000.5e00.0202
VRF          : Default
Advt timer   : 1 second(s)
Preempt mode : TRUE
Conf pri     : 200          Run pri   : 255
Master router ip : fe80::b002:86ff:febc:3700
Master priority : 255
Master advt timer : 100 centi-second(s)
Master down timer : 3 second(s)
Preempt delay  : 0 second(s)

```

IPv6 VRRP Circuit Failover

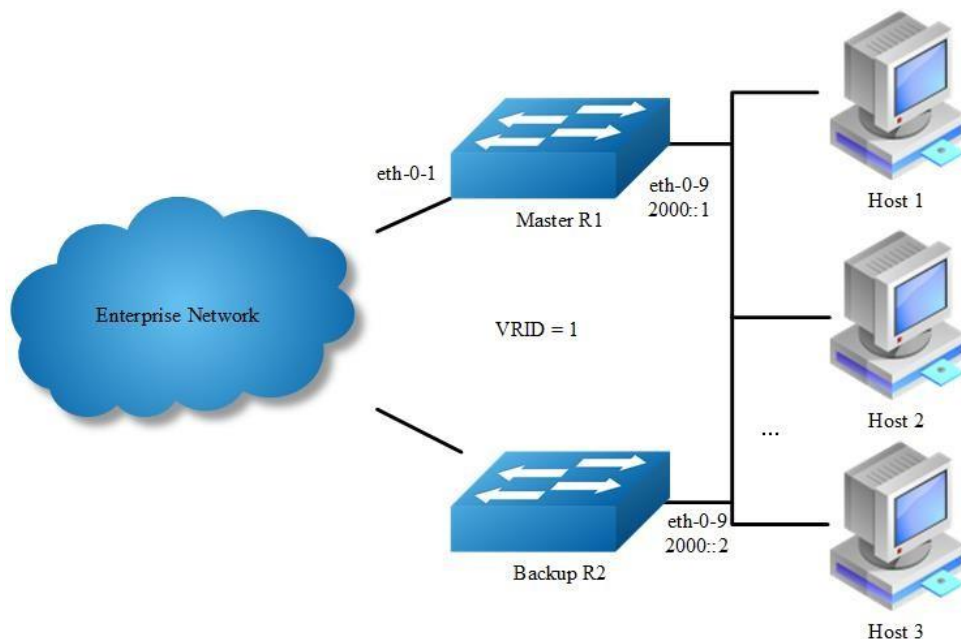

Figure 16-28 IPv6 VRRP Circuit Failover

The need for VRRP Circuit Failover arose because VRRPv2 was unable to track the gateway interface status. The VRRP Circuit Failover feature provides a dynamic failover of an entire circuit in the event that one member of the group fails. It introduces the concept of a circuit, where two or more Virtual Routers on a single system can be grouped. In the event that a failure occurs and one of the Virtual Routers performs the Master to Backup transition, the other Virtual Routers in the group are notified and are forced into the Master to Backup transition, so that both incoming and outgoing packets are routed through the same gateway router, eliminating the problem for Firewall/NAT environments. The following scenario explains this feature.

To configure VRRP Circuit Failover, each circuit is configured to have a corresponding priority-delta value, which is passed to VRRP when a failure occurs. The priority of each Virtual Router on the circuit is decremented by the priority delta value causing the VR Master to VR Backup transition.

In this example, two routers R1 and R2 are configured as backup routers with different priorities. The priority-delta value is configured to be greater than the difference of both the priorities. R1 is configured to have a priority of 100 and R2 has a priority of 90. R1 with a greater priority is the Virtual Router Master. The priority-delta value is 20, greater than 10 (100 minus 90). On R1 when the external interface eth1 fails, the priority of R1 becomes 80 (100 minus 20). Since R2 has a greater priority (90) than R1, R2 becomes the VR Master and routing of packages continues without interruption.

When this VR Backup (R1) is up again, it regains its original priority (100) and becomes the VR Master again.

The following configuration should be operated on all devices if the device ID is not specified.

step 1 Enter the configure mode and enable IPv6

```
Switch# configure terminal
Switch(config)# ipv6 enable
```

step 2 Enter the interface configure mode and set the attributes of the interface

Interface configuration for R1:

```
Switch(config)# interface eth-0-9
Switch(config-if)# no switchport
Switch(config-if)# ipv6 address 2000::1/64
Switch(config-if)# no shutdown
Switch(config-if)# exit

Switch(config)# interface eth-0-1
Switch(config-if)# no shutdown
Switch(config-if)# exit
```

Interface configuration for R2:

```
Switch(config)# interface eth-0-9
Switch(config-if)# no switchport
Switch(config-if)# ipv6 address 2000::2/64
Switch(config-if)# no shutdown
Switch(config-if)# exit
```

step 3 Create an track object to monitor the link state

Configuring R1:

```
Switch(config)# track 10 interface eth-0-1 linkstate
```

To get more information about track, please reference to the "Configuring Track" chapter.

step 4 Create an instance of IPv6 VRRP

Configuring R1:

```
Switch(config)# router ipv6 vrrp 1
Switch(config-router)# interface eth-0-9
Switch(config-router)# virtual-ipv6 fe80::1 link-local
Switch(config-router)# virtual-ipv6 2000::3
Switch(config-router)# track 10 decrement 20
Switch(config-router)# enable
```

Configuring R2:

```
Switch(config)# router ipv6 vrrp 1
Switch(config-router)# interface eth-0-9
Switch(config-router)# priority 90
Switch(config-router)# virtual-ipv6 fe80::1 link-local
Switch(config-router)# virtual-ipv6 2000::3
Switch(config-router)# enable
```

step 5 Exit the configure mode

```
Switch(config)# end
```

step 6 Validation

Display the result on R1.

```
Switch# show ipv6 vrrp
IPv6 vrrp session count: 1
VRID <1>
  State           : Master
  Virtual IP      : fe80::1 (Not IP owner)
                  2000::3 (Not IP owner)
  Interface       : eth-0-9
  VMAC            : 0000.5e00.0201
  VRF             : Default
  Advt timer      : 1 second(s)
  Preempt mode    : TRUE
  Conf pri        : 100           Run pri   : 100
  Track Object    : 10           Decre pri : 20
  Master router ip : fe80::48cc:69ff:fec8:5b00
  Master priority : 100
  Master advt timer : 100 centi-second(s)
  Master down timer : 4 second(s)
  Preempt delay   : 0 second(s)
```

Display the result on R2.

```
Switch# show ipv6 vrrp
IPv6 vrrp session count: 1
VRID <1>
  State           : Backup
  Virtual IP      : fe80::1 (Not IP owner)
                  2000::3 (Not IP owner)
  Interface       : eth-0-9
  VMAC            : 0000.5e00.0201
  VRF             : Default
  Advt timer      : 1 second(s)
  Preempt mode    : TRUE
  Conf pri        : 90           Run pri   : 90
  Master router ip : fe80::48cc:69ff:fec8:5b00
  Master priority : 100
  Master advt timer : 100 centi-second(s)
  Master down timer : 4 second(s)
  Preempt delay   : 0 second(s)
```

step 7 Shutdown port eth-0-1 of R1, Exit the configure mode

```
Switch# configure terminal
Switch(config)# interface eth-0-1
Switch(config-if)# shutdown
Switch(config-if)# end
```

step 8 Validation, R1 change to backup and R2 change to master

Display the result on R1.

```
Switch# show ipv6 vrrp
IPv6 vrrp session count: 1
VRID <1>
  State           : Backup
  Virtual IP      : fe80::1 (Not IP owner)
                  2000::3 (Not IP owner)
  Interface       : eth-0-9
  VMAC            : 0000.5e00.0201
  VRF             : Default
  Advt timer      : 1 second(s)
  Preempt mode    : TRUE
  Conf pri        : 100           Run pri   : 80
  Track Object    : 10           Decre pri : 20
  Master router ip : fe80::b002:86ff:febc:3700
  Master priority : 90
  Master advt timer : 100 centi-second(s)
  Master down timer : 4 second(s)
  Preempt delay   : 0 second(s)
```

Display the result on R2.

```
Switch# show ipv6 vrrp
IPv6 vrrp session count: 1
VRID <1>
  State           : Master
  Virtual IP      : fe80::1 (Not IP owner)
                  2000::3 (Not IP owner)
  Interface       : eth-0-9
  VMAC            : 0000.5e00.0201
  VRF             : Default
  Advt timer      : 1 second(s)
  Preempt mode    : TRUE
  Conf pri        : 90           Run pri   : 90
  Master router ip : fe80::b002:86ff:febc:3700
  Master priority : 90
  Master advt timer : 100 centi-second(s)
  Master down timer : 4 second(s)
  Preempt delay   : 0 second(s)
```

16.12.3 Application cases

N/A

16.13 Configuring Track

16.13.1 Overview

Function Introduction

Track is used for link the functional modules and monitor modules. Track builds a system structure with 3 levels: "functional modules -- Track -- monitor modules".

Track can shield the difference of the monitor modules and provide an unitized API for the functional modules.

The following monitor modules are supported:

- IP SLA
- interface states
- bfd states

The following functional modules are supported:

- Static route
- VRRP

Track makes a communication for the functional modules and monitor modules. When link states or network performance is changed, the monitor modules can detect the event and notify the track module; therefore track will change its owner states and notify the related functional modules.

Principle Description

N/A

16.13.2 Configuration

Configuring IP SLA for interfaces in the VRF

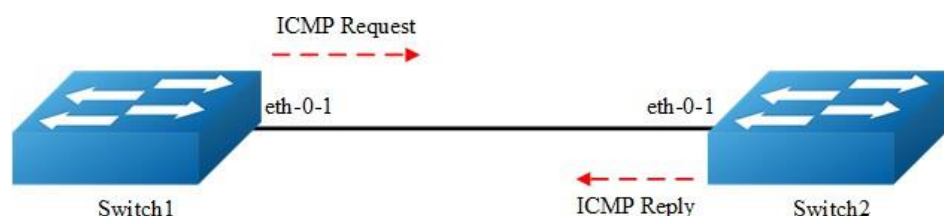

Figure 16-29 IP SLA

IP SLA (Service Level Agreement) is a network performance measurement and diagnostics tool that uses active monitoring. Active monitoring is the generation of traffic in a reliable and predictable manner to measure network performance. Every IP SLA operation maintains an operation return-code value. This return code is interpreted by the tracking process. The return code can return OK, Over Threshold, and several other return codes. Different operations can have different return-code values, so only values common to all operation types are used. In IP SLA, use `icmp echo` to check state or reachability of a route.

The following configuration should be operated on all switches if the switch ID is not specified.

step 1 Enter the configure mode

```
Switch# configure terminal
```

step 2 Create a vrf instance

```
Switch(config)# ip vrf vpn1
Switch(config-vrf)# exit
```

step 3 Enter the interface configure mode and set the attributes of the interface

Interface configuration for Switch1:

```
Switch(config)# interface eth-0-1
Switch(config-if)# no switchport
Switch(config-if)# no shutdown
Switch(config-if)# ip vrf forwarding vpn1
```

```
Switch(config-if)# ip address 192.168.0.2/24
Switch(config-if)# exit
```

Interface configuration for Switch2:

```
Switch(config)# interface eth-0-1
Switch(config-if)# no switchport
Switch(config-if)# no shutdown
Switch(config-if)# ip vrf forwarding vpn1
Switch(config-if)# ip address 192.168.0.1/24
Switch(config-if)# exit
```

step 4 Create ip sla and set the attributes

Configuring Switch1:

```
Switch(config)# ip sla monitor 1
Switch(config-ipsla)# type icmp-echo 192.168.0.1
Switch(config-ipsla)# frequency 35
Switch(config-ipsla)# timeout 6
Switch(config-ipsla)# threshold 3000
Switch(config-ipsla)# ttl 65
Switch(config-ipsla)# tos 1
Switch(config-ipsla)# data-size 29
Switch(config-ipsla)# data-pattern abababab
Switch(config-ipsla)# fail-percent 90
Switch(config-ipsla)# packets-per-test 4
Switch(config-ipsla)# interval 9
Switch(config-ipsla)# statistics packet 10
Switch(config-ipsla)# statistics test 3
Switch(config-ipsla)# vrf vpn1
Switch(config-ipsla)# exit
```



NOTE

Parameters for ip sla:

- **frequency:**Time between 2 probes. Valid range is 1-4800 second, default value is 60 seconds.
- **timeout:**Timeout value for icmp reply. Valid range is 1-4800 second, default value is 5 seconds.
- **threshold:** Timeout value for icmp threshold. Valid range is 1-4800000 millisecond, default value is 5000 millisecond.
- **packets-per-test:**Packet number for each probe. Valid range is 1-10, default value is 3.
- **interval:**Time between 2 packets. Valid range is 1-4800 second, default value is 6 seconds.

- statistics packet: Packet number for statistics. Valid range is 0-1000, default value is 50.
- statistics test probe number for statistics. Valid range is 0-10, default value is 5

step 5 Enable ip sla

Configuring Switch1:

```
Switch(config)# ip sla monitor schedule 1
```

step 6 Exit the configure mode

```
Switch(config)# end
```

step 7 Validation

Display the result on Switch1.

```
Switch# sho ip sla monitor 1
Entry 1
Type           : Echo
Admin state    : Disable
Destination address : 192.168.0.1
Frequency      : 35s
Timeout        : 6s
Threshold      : 3000ms
Interval       : 9s
Packet per test : 4
TTL            : 65
TOS            : 1
Data Size      : 29 bytes
Fail Percent   : 90%
Packet Item Cnt : 10
Test Item Cnt  : 3
Vrf            : vpn1
Return code    : Unknown
```

Configuring IP SLA for Layer3 interfaces

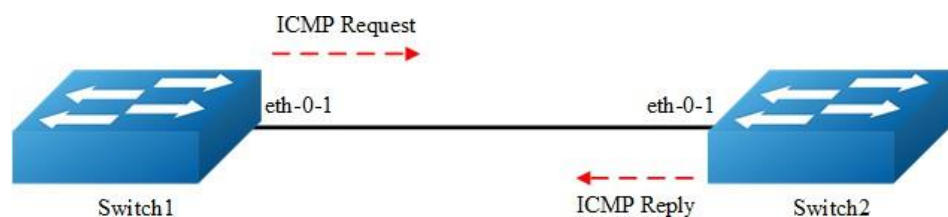

Figure 16-30 IP SLA

The following configuration should be operated on all switches if the switch ID is not specified.:

step 1 Enter the configure mode

```
Switch# configure terminal
```

step 2 Enter the interface configure mode and set the attributes of the interface

Interface configuration for Switch1:

```
Switch(config)# interface eth-0-1
Switch(config-if)# no switchport
Switch(config-if)# no shutdown
Switch(config-if)# ip address 192.168.0.2/24
Switch(config-if)# exit
```

Interface configuration for Switch2:

```
Switch(config)# interface eth-0-1
Switch(config-if)# no switchport
Switch(config-if)# no shutdown
Switch(config-if)# ip address 192.168.0.1/24
Switch(config-if)# exit
```

step 3 Create ip sla and set the attributes

Configuring Switch1:

```
Switch(config)# ip sla monitor 1
Switch(config-ipsla)# type icmp-echo 192.168.0.1
Switch(config-ipsla)# frequency 10
Switch(config-ipsla)# timeout 5
Switch(config-ipsla)# exit
```

step 4 Enable ip sla

Configuring Switch1:

```
Switch(config)# ip sla monitor schedule 1
```

step 5 Exit the configure mode

```
Switch(config)# end
```

step 6 Validation

Display the result on Switch1.

```
Switch# show ip sla monitor
Entry 1
  Type                : Echo
  Admin state         : Enable
  Destination address  : 192.168.0.1
  Frequency            : 10 seconds
  Timeout              : 5 seconds
  Threshold            : 5 seconds
  Running Frequency    : 8 seconds
  Return code          : OK

Switch# ping 192.168.0.1
PING 192.168.0.1 (192.168.0.1) 56(84) bytes of data.
64 bytes from 192.168.0.1: icmp_seq=1 ttl=64 time=0.846 ms
64 bytes from 192.168.0.1: icmp_seq=2 ttl=64 time=0.643 ms
64 bytes from 192.168.0.1: icmp_seq=3 ttl=64 time=0.978 ms
64 bytes from 192.168.0.1: icmp_seq=4 ttl=64 time=0.640 ms
64 bytes from 192.168.0.1: icmp_seq=5 ttl=64 time=0.704 ms
```

Shutdown the interface eth-0-1 on Switch2.

```
Switch(config)# interface eth-0-1
Switch(config-if)# shutdown
```

Display the result on Switch1 again.

```
Switch# show ip sla monitor
Entry 1
  Type                : Echo
  Admin state         : Enable
  Destination address  : 192.168.0.1
  Frequency            : 10 seconds
  Timeout              : 5 seconds
  Threshold            : 5 seconds
  Running Frequency    : 9 seconds
  Running Timeout      : 4 seconds
  Running Threshold    : 4 seconds
  Return code          : Timeout
```

Configuring IP SLA for outgoing interface of static route

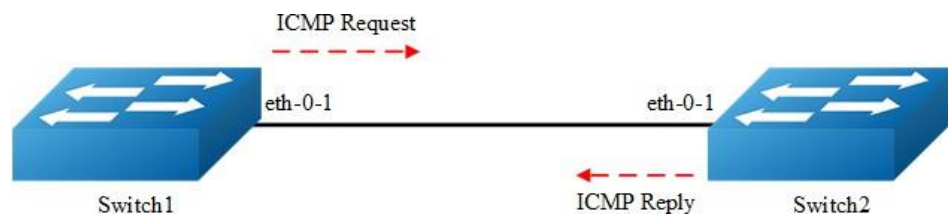

Figure 16-31 IP SLA

The following configuration should be operated on all switches if the switch ID is not specified.:

step 1 Enter the configure mode

```
Switch# configure terminal
```

step 2 Enter the interface configure mode and set the attributes of the interface

Interface configuration for Switch1:

```
Switch(config)# interface eth-0-1
Switch(config-if)# no switchport
Switch(config-if)# no shutdown
Switch(config-if)# ip address 192.168.0.2/24n
Switch(config-if)# exit
```

Interface configuration for Switch2:

```
Switch(config)# interface eth-0-1
Switch(config-if)# no switchport
Switch(config-if)# no shutdown
Switch(config-if)# ip address 192.168.0.1/24
Switch(config-if)# exit

Switch(config)# interface loopback 1
Switch(config-if)# ip address 1.1.1.1/32
Switch(config-if)# exit
```

step 3 Create ip sla and set the attributes

Configuring Switch1:

```
Switch(config)# ip sla monitor 2
Switch(config-ipsla)# type icmp-echo 1.1.1.1
Switch(config-ipsla)# frequency 10
Switch(config-ipsla)# timeout 5
Switch(config-ipsla)# exit
```

step 4 Enable ip sla

Configuring Switch1:

```
Switch(config)# ip sla monitor schedule 2
```

step 5 Exit the configure mode

```
Switch(config)# end
```

step 6 Validation

Display the result on Switch1.

```
Switch# show ip sla monitor 2
Entry 2
  Type                : Echo
  Admin state          : Enable
  Destination address  : 1.1.1.1
  Frequency             : 10 seconds
  Timeout              : 5 seconds
  Threshold            : 5 seconds
  Running Frequency    : 1 seconds
  Return code          : Unreachable
Switch# ping 1.1.1.1
connect: Network is unreachable
```

Create a static route on Switch1

```
Switch#configure terminal
Switch(config)# ip route 1.1.1.1/32 192.168.0.1
Switch(config)# end
```

Display the result on Switch1 again.

```
Switch# ping 1.1.1.1
PING 1.1.1.1 (1.1.1.1) 56(84) bytes of data.
64 bytes from 1.1.1.1: icmp_seq=1 ttl=64 time=1.03 ms
64 bytes from 1.1.1.1: icmp_seq=2 ttl=64 time=1.63 ms
64 bytes from 1.1.1.1: icmp_seq=3 ttl=64 time=0.661 ms
64 bytes from 1.1.1.1: icmp_seq=4 ttl=64 time=0.762 ms
64 bytes from 1.1.1.1: icmp_seq=5 ttl=64 time=0.942 ms

Entry 2
  Type                : Echo
  Admin state          : Enable
  Destination address  : 1.1.1.1
  Frequency             : 10 seconds
  Timeout              : 5 seconds
  Threshold            : 5 seconds
  Running Frequency    : 8 seconds
  Return code          : OK
```

Configuring track interface linkstate

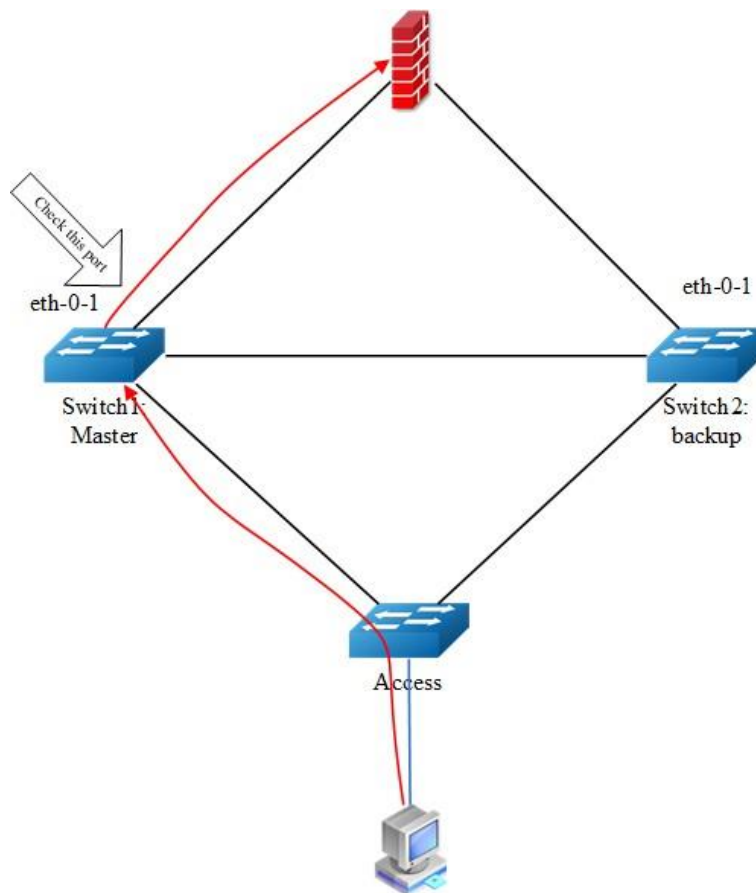

Figure 16-32 Track interface

Before the introduction of track feature, the VRRP had a simple tracking mechanism that allowed you to track the interface link state only. If the link state of the interface went down, the VRRP priority of the router was reduced, allowing another VRRP router with a higher priority to become active. The Track feature separates the tracking mechanism from VRRP and creates a separate standalone tracking process that can be used by other processes in future. This feature allows tracking of other objects in addition to the interface link state. VRRP can now register its interest in tracking objects and then be notified when the tracked object changes state. TRACK is a separate standalone tracking process that can be used by other processes as well as VRRP. This feature allows tracking of other objects in addition to the interface link state.

Configuring Switch1:

step 1 Enter the configure mode

```
Switch# configure terminal
```

step 2 Create track and set the attributes

```
Switch(config)# track 1 interface eth-0-1 linkstate
Switch(config-track)# delay up 30
Switch(config-track)# delay down 30
Switch(config-track)# exit
```



NOTE

Parameters for track:

- **delay up:** After the interface states is up, the track will wait for a cycle before restore the states. Valid range is 1-180 second. The default configuration is restore without delay.
- **delay down:** After the interface states is down, the track will wait for a cycle before change the states. Valid range is 1-180 second. The default configuration is change without delay.



NOTE

If the track is using bfd or ip sla, the "delay up" and "delay down" is similar as using interface states.

step 3 Exit the configure mode

```
Switch(config)# end
```

step 4 Validation

```
Switch#show track
Track 2
  Type           : Interface Link state
  Interface      : eth-0-1
  State          : down
  Delay up       : 30 seconds
  Delay down     : 30 seconds
```

Configuring track ip sla reachability

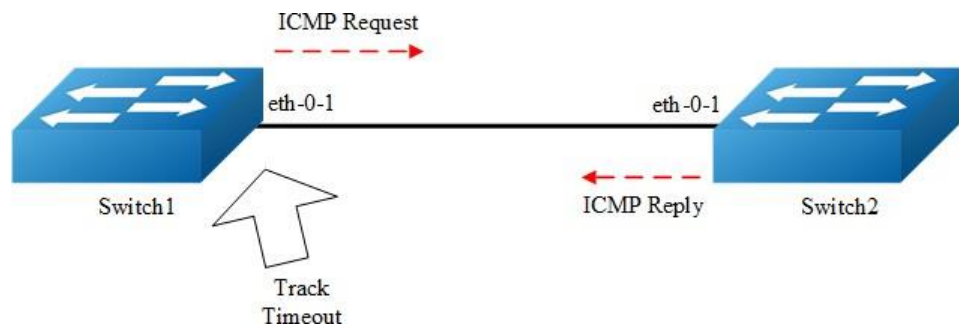

Figure 16-33 Track ip sla

The following configuration should be operated on all switches if the switch ID is not specified.:

step 1 Enter the configure mode

```
Switch# configure terminal
```

step 2 Enter the interface configure mode and set the attributes of the interface

Interface configuration for Switch1:

```
Switch(config)# interface eth-0-1
Switch(config-if)# no switchport
Switch(config-if)# no shutdown
Switch(config-if)# ip address 192.168.0.2/24
```

Interface configuration for Switch2:

```
Switch(config)# interface eth-0-1
Switch(config-if)# no switchport
Switch(config-if)# no shutdown
Switch(config-if)# ip address 192.168.0.1/24
```

step 3 Create ip sla and enable it

Configuring Switch1:

```
Switch(config)# ip sla monitor 1
Switch(config-ipsla)# type icmp-echo 192.168.0.1
Switch(config-ipsla)# frequency 10
Switch(config-ipsla)# timeout 5
Switch(config-ipsla)# threshold 1
Switch(config-ipsla)# exit
Switch(config)# ip sla monitor schedule 1
```

step 4 Create track and set the attributes

Configuring Switch1:

```
Switch(config)# track 1 rtr 1 reachability
Switch(config-track)# delay up 30
Switch(config-track)# delay down 30
Switch(config-track)#exit
```

step 5 Exit the configure mode

```
Switch(config)# end
```

step 6 Validation

```
Switch#show track
Track 1
  Type                : Response Time Reporter (RTR) Reachability
  RTR entry number    : 1
  State               : up
  Delay up            : 30 seconds
  Delay down          : 30 seconds
```

Configuring track ip sla state

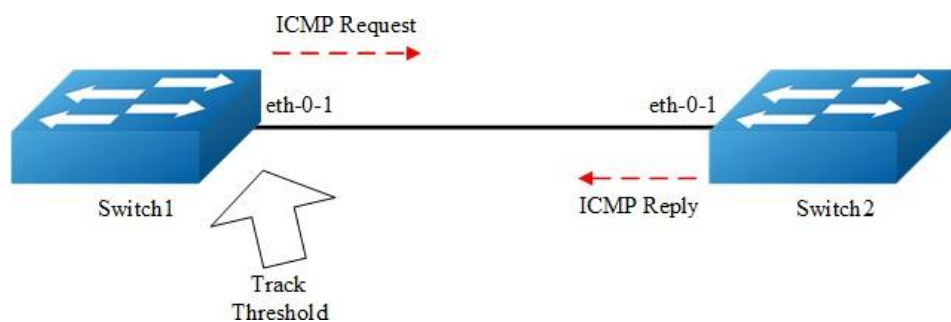

Figure 16-34 Track ip sla

The following configuration should be operated on all switches if the switch ID is not specified.:

step 1 Enter the configure mode

```
Switch# configure terminal
```

step 2 Enter the interface configure mode and set the attributes of the interface

Interface configuration for Switch1:

```
Switch(config)# interface eth-0-1
Switch(config-if)# no switchport
Switch(config-if)# no shutdown
Switch(config-if)# ip address 192.168.0.2/24
```

Interface configuration for Switch2:

```
Switch(config)# interface eth-0-1
Switch(config-if)# no switchport
Switch(config-if)# no shutdown
Switch(config-if)# ip address 192.168.0.1/24
```

step 3 Create ip sla and enable it

Configuring Switch1:

```
Switch(config)# ip sla monitor 1
Switch(config-ipsla)# type icmp-echo 192.168.0.1
Switch(config-ipsla)# frequency 10
Switch(config-ipsla)# timeout 5
Switch(config-ipsla)# threshold 1
Switch(config-ipsla)# exit
Switch(config)# ip sla monitor schedule 1
```

step 4 Create track and set the attributes

Configuring Switch1:

```
Switch(config)# track 1 rtr 1 state
Switch(config-track)# delay up 30
Switch(config-track)# delay down 30
Switch(config-track)#exit
```

step 5 Exit the configure mode

```
Switch(config)# end
```

step 6 Validation

```
Switch# show track
Track 1
  Type                : Response Time Reporter (RTR) State
  RTR entry number    : 1
  State                : up
  Delay up             : 30 seconds
  Delay down           : 30 seconds
```

Configuring track bfd

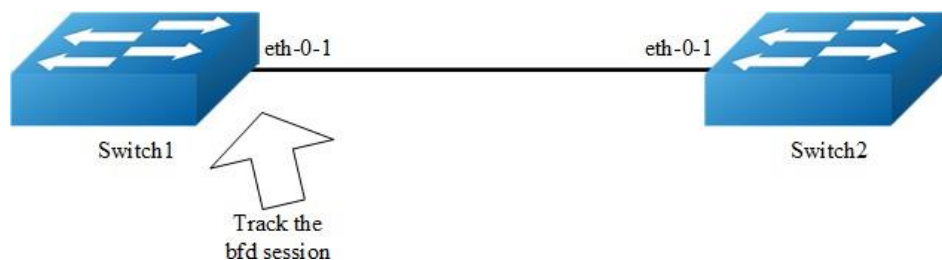

Figure 16-35 Track bfd

The following configuration should be operated on all switches if the switch ID is not specified.:

step 1 Enter the configure mode

```
Switch# configure terminal
```

step 2 Enter the interface configure mode and set the attributes of the interface

Interface configuration for Switch1:

```
Switch(config)# interface eth-0-1
Switch(config-if)# no switchport
Switch(config-if)# no shutdown
Switch(config-if)# ip address 9.9.9.1/24
Switch(config-if)# quit
```

Interface configuration for Switch2:

```
Switch(config)# interface eth-0-1
Switch(config-if)# no switchport
Switch(config-if)# no shutdown
Switch(config-if)# ip address 9.9.9.2/24
Switch(config-if)# quit
```

step 4 Create track and set the attributes

Configuring Switch1:

```
Switch(config)# track 1 bfd source interface eth-0-1 destination 9.9.9.2
Switch(config-track)# delay up 30
Switch(config-track)# delay down 30
Switch(config-track)# exit
```

Configuring Switch2:

```
Switch(config)# track 1 bfd source interface eth-0-1 destination 9.9.9.1
Switch(config-track)# delay up 30
Switch(config-track)# delay down 30
Switch(config-track)# exit
```

step 5 Exit the configure mode

```
Switch(config)# end
```

step 6 Validation

Display the result on Switch1.

```
Switch #show track
Track 1
  Type           : BFD state
  Source interface : eth-0-1
  Destination IP  : 9.9.9.2
  BFD Local discr : 1
  State          : up
```

Display the result on Switch2.

```
Switch # show track
Track 1
  Type           : BFD state
  Source interface : eth-0-1
  Destination IP  : 9.9.9.1
  BFD Local discr : 1
  State          : up
```

Configuring track for vrrp

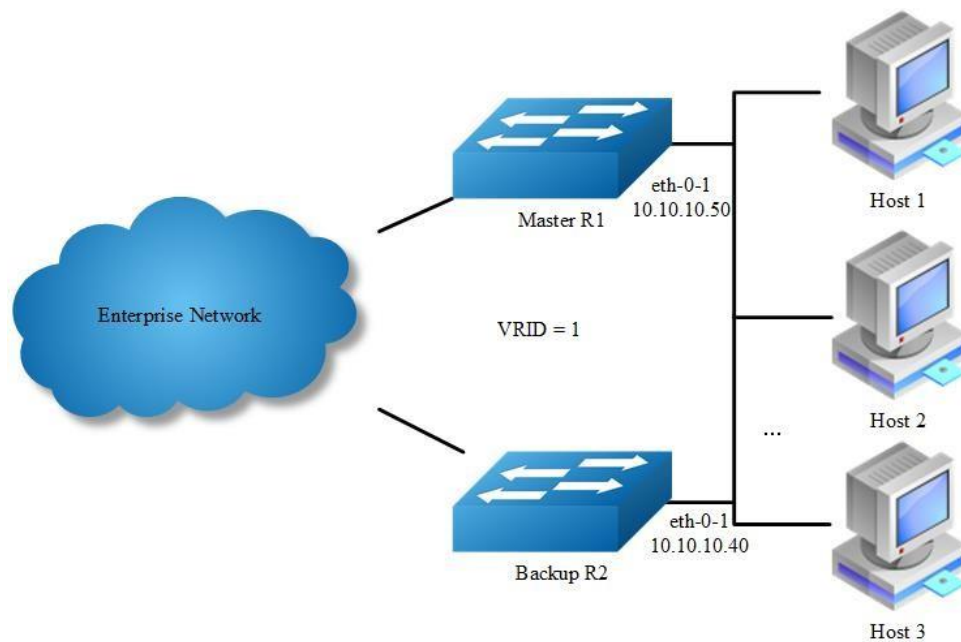

Figure 16-36 VRRP Track

step 1 Check current configuration

Reference to chapter "Configuring VRRP" - "Configuring VRRP (One Virtual Router)"

Display the configuration on R1.

```
interface eth-0-1
 no switchport
 ip address 10.10.10.50/24
!
router vrrp 1
 interface eth-0-1
  virtual-ip 10.10.10.60
  advertisement-interval 5
 enable
```

Display the configuration on R2.

```
interface eth-0-1
 no switchport
 ip address 10.10.10.40/24
!
router vrrp 1
 interface eth-0-1
  priority 200
  virtual-ip 10.10.10.60
```

```
advertisement-interval 5
enable
```

step 2 Create track and set the attributes

Create track on Switch1

绑定端口状态

```
Switch(config)# track 1 interface eth-0-1 linkstate
Switch(config-track)# exit
```

或者绑定cfm 状态（cfm 配置参考“配置cfm”章节）

```
Switch(config)# track 1 cfm domain cust service cst
Switch(config-track)# exit
```

注：如果希望关注CCM 报文中 RDI 的状态，可以使用以下指令

```
Switch(config)# track 1 cfm domain cust service cst rdi-trigger
```

step 3 Apply track for vrrp

Apply track on Switch1

```
Switch(config)# router vrrp 1
Switch(config-router)# disable
Switch(config-router)# track 1 decrement 30
Switch(config-router)# enable
```

step 4 Validation

Display the result on Switch1.

```
Switch# show vrrp
vrrp session count: 1
VRID <1>
  State           : Backup
  Virtual IP      : 10.10.10.60 (Not IP owner)
  Interface       : eth-0-9
  VMAC           : 0000.5e00.0101
  VRF             : Default
  Advt timer     : 5 second(s)
  Preempt mode   : TRUE
  Conf pri       : Unset           Run pri   : 100
  Increased pri  : 0
  Track Object   : 1
  Decre pri     : 30
  Master router ip : 10.10.10.40
  Master priority : 200
  Master advt timer : 5 second(s)
  Master down timer : 16 second(s)
```



```
Preempt delay      : 0 second(s)
Learn master mode  : FALSE
BFD session state  : UNSET
```

Configuring track for static route



Figure 16-37 Static Route Track

The following configuration should be operated on all switches if the switch ID is not specified.:

step 1 Enter the configure mode

```
Switch# configure terminal
```

step 2 Enter the interface configure mode and set the attributes of the interface

Interface configuration for Switch1:

```
Switch(config)#interface eth-0-1
Switch(config-if)# no switchport
Switch(config-if)# no shutdown
Switch(config-if)# ip address 192.168.1.10/24
Switch(config-if)# exit
```

Interface configuration for Switch2:

```
Switch(config)#interface eth-0-1
Switch(config-if)# no switchport
Switch(config-if)# no shutdown
Switch(config-if)# ip address 192.168.1.11/24
Switch(config-if)# exit
```

step 3 Create ip sla and enable it

Configuring Switch1:

```
Switch(config)# ip sla monitor 1
Switch(config-ipsla)# type icmp-echo 192.168.1.11
Switch(config-ipsla)# exit
Switch(config)# ip sla monitor schedule 1
```

step 4 Create track and set the attributes

Configuring Switch1:

```
Switch(config)# track 1 rtr 1 reachability
Switch(config-track)# exit
```

step 5 Apply track for static route

```
Switch(config)#ip route 10.10.10.0/24 192.168.1.11 track 1
```

step 6 Exit the configure mode

```
Switch(config)# end
```

step 7 Validation

Display the result on Switch1.

```
Switch# show ip sla monitor 1
Entry 1
  Type           : Echo
  Admin state    : Enable
  Destination address : 192.168.1.11
  Frequency      : 60 seconds
  Timeout        : 5 seconds
  Threshold      : 5 seconds
  Running Frequency : 49 seconds
Return code      : OK

Switch# show track 1
Track 1
  Type           : Response Time Reporter (RTR) Reachability
  RTR entry number : 1
  State          : up
Switch# show ip route static
S      10.10.10.0/24 [1/0] via 192.168.1.11, eth-0-1
```

Shutdown the interface eth-0-1 on Switch2.

```
Switch(config)# interface eth-0-1
Switch(config-if)# shutdown
```

Display the result on Switch1 again.

```
Switch# show ip sla monitor 1
Entry 1
  Type           : Echo
  Admin state    : Enable
  Destination address : 192.168.1.11
  Frequency      : 60 seconds
  Timeout        : 5 seconds
```

```
Threshold          : 5 seconds
Running Frequency  : 8 seconds
Return code        : Timeout
Switch# show track 1
Track 1
  Type              : Response Time Reporter (RTR) Reachability
  RTR entry number  : 1
  State             : down
Switch# show ip route static
Switch#
```

16.13.3 Application cases

N/A

16.14 Configuring IP BFD

16.14.1 Overview

Function Introduction

An increasingly important feature of networking equipment is the rapid detection of communication failures between adjacent systems, in order to more quickly establish alternative paths. Detection can come fairly quickly in certain circumstances when data link hardware comes into play (such as Synchronous Optical Network (SONET) alarms). However, there are media that do not provide this kind of signaling (such as Ethernet), and some media may not detect certain kinds of failures in the path, for example, failing interfaces or forwarding engine components.

Networks use relatively slow "Hello" mechanisms, usually in routing protocols, to detect failures when there is no hardware signaling to help out. The time to detect failures ("Detection Times") available in the existing protocols is no better than a second, which is far too long for some applications and represents a great deal of lost data at gigabit rates. Furthermore, routing protocol Hellos are of no help when those routing protocols are not in use, and the semantics of detection are subtly different -- they detect a failure in the path between the two routing protocol engines.

The goal of Bidirectional Forwarding Detection (BFD) is to provide low-overhead, short-duration detection of failures in the path between adjacent forwarding engines,

including the interfaces, data link(s), and, to the extent possible, the forwarding engines themselves.

An additional goal is to provide a single mechanism that can be used for aliveness detection over any media, at any protocol layer, with a wide range of Detection Times and overhead, to avoid a proliferation of different methods.



NOTE If ethernet CFM mep is configured on a physical port and CFM LM is enabled, at the same time, IP BFD is configured on a vlan interface and the former physical port is a member of the vlan, IP BFD can't work normally. If CFM LM is disabled, IP BFD can work normally.

Principle Description

Reference RFC 5880 Bidirectional Forwarding Detection (BFD)

16.14.2 Configuration

Configure BFD single hop

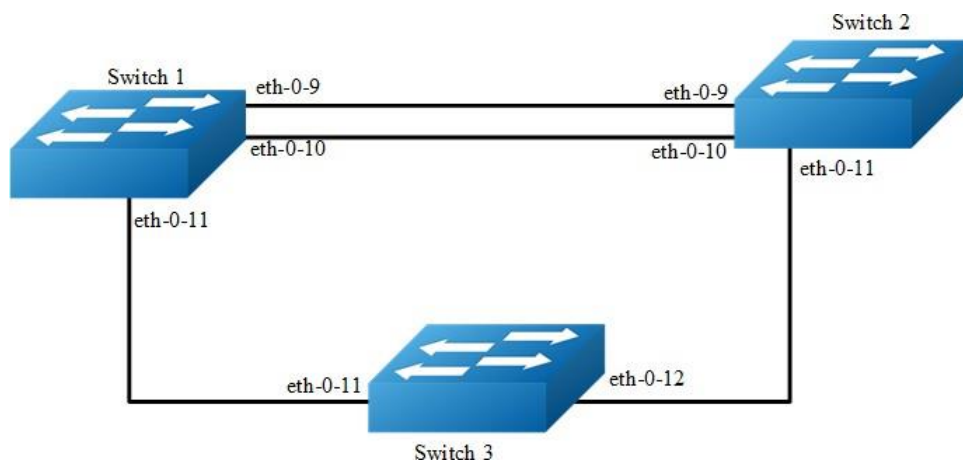

Figure 16-38 BFD single hop

This topology and configuration is for three BFD session ,one session based on static configuration with static route,next session based on OSPF ,and last session relate vrrp.

The following configuration should be operated on all switches if the switch ID is not specified.

step 1 Enter the configure mode

```
Switch# configure terminal
```

step 2 Enter the interface configure mode and set the attributes of the interface

Interface configuration for Switch1:

```
Switch(config)# interface eth-0-9
Switch(config-if)# no switchport
Switch(config-if)# no shutdown
Switch(config-if)# ip address 9.9.9.1/24
Switch(config-if)# bfd interval mintx 3 minrx 3 multiplier 3
Switch(config-if)# exit

Switch(config)# interface eth-0-10
Switch(config-if)# no switchport
Switch(config-if)# no shutdown
Switch(config-if)# ip address 10.10.10.1/24
Switch(config-if)# bfd interval mintx 3 minrx 3 multiplier 3

Switch(config)# interface eth-0-11
Switch(config-if)# no switchport
Switch(config-if)# no shutdown
Switch(config-if)# ip address 11.11.11.1/24
Switch(config-if)# exit
```

Interface configuration for Switch2:

```
Switch(config)# interface eth-0-9
Switch(config-if)# no switchport
Switch(config-if)# no shutdown
Switch(config-if)# ip address 9.9.9.2/24
Switch(config-if)# bfd interval mintx 3 minrx 3 multiplier 3
Switch(config-if)# exit

Switch(config)# interface eth-0-10
Switch(config-if)# no switchport
Switch(config-if)# no shutdown
Switch(config-if)# ip address 10.10.10.2/24
Switch(config-if)# bfd interval mintx 3 minrx 3 multiplier 3
Switch(config-if)# ip ospf bfd
Switch(config-if)# exit

Switch(config)# interface eth-0-11
Switch(config-if)# no switchport
Switch(config-if)# no shutdown
Switch(config-if)# ip address 11.11.11.2/24
Switch(config-if)# exit
```

Interface configuration for Switch3:

```
Switch(config)# interface eth-0-11
Switch(config-if)# no shutdown
```

```
Switch(config-if)#exit

Switch(config)# interface eth-0-12
Switch(config-if)# no shutdown
Switch(config-if)#exit
```

step 3 Configuring ospf

Configuring Switch1:

```
Switch(config)# router ospf
Switch(config-router)# network 10.10.10.0/24 area 0
Switch(config-router)# exit
```

Configuring Switch2:

```
Switch(config)# router ospf
Switch(config-router)# network 10.10.10.0/24 area 0
Switch(config-router)# exit
```

step 4 Configuring vrrp

Configuring Switch1:

```
Switch(config)#router vrrp 1
Switch(config-router)#virtual-ip 11.11.11.100
Switch(config-router)# priority 120
Switch(config-router)#interface eth-0-11
Switch(config-router)# enable
Switch(config-router)# exit
```

Configuring Switch2:

```
switch(config)#bfd test peer-ip 11.11.11.1 interface eth-0-11 auto
switch(config)#track 1 bfd session test
Switch(config)#router vrrp 1
Switch(config-router)#virtual-ip 11.11.11.100
Switch(config-router)# priority 100
Switch(config-router)#interface eth-0-11
Switch(config-router)# track 1 increment 50
Switch(config-router)# enable
Switch(config-router)# exit
```

step 5 Configuring static route

Configuring Switch1:

```
Switch(config)# bfd test peer-ip 9.9.9.2 interface eth-0-9 auto
Switch(config)# ip route 1.1.1.0/24 9.9.9.2 bind bfd test
```

Configuring Switch2:

```
Switch(config)# bfd test peer-ip 9.9.9.1 interface eth-0-9 auto
Switch(config)# ip route 2.2.2.0/24 9.9.9.1 bind bfd test
```

step 6 Exit configure mode

```
Switch(config)# end
```

step 7 Validation

Display Switch1 results:

```
Switch# show bfd session
abbreviation:
LD: local Discriminator.      RD: Discriminator
S: single hop session.      M: multi hop session.
SD: Static Discriminator.    DD: Dynamic Discriminator
A: Admin down.      D:down.      I:init.      U:up.
=====
LD  RD  TYPE ST  UP-Time    Remote-Addr    vrf
1   1   S-DD U    00:01:05    9.9.9.2        default
2   2   S-DD U    00:00:25    10.10.10.2     default
Number of Sessions:      2
```

Display Switch2 results:

```
Switch# show bfd session
abbreviation:
LD: local Discriminator.      RD: Discriminator
S: single hop session.      M: multi hop session.
SD: Static Discriminator.    DD: Dynamic Discriminator
A: Admin down.      D:down.      I:init.      U:up.
=====
LD  RD  TYPE ST  UP-Time    Remote-Addr    vrf
1   1   S-DD U    00:01:27    9.9.9.1        default
2   2   S-DD U    00:00:46    10.10.10.1     default
3   3   S-DD U    00:00:25    11.11.11.1     default
Number of Sessions:      3
```

Configuring BFD multi-hop

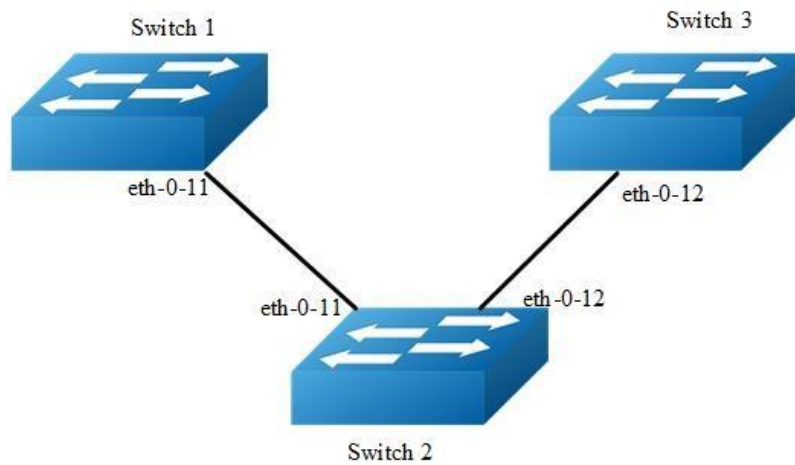

Figure 16-39 BFD multi hop

This topology and configuration is for one BFD session which is based on static multiple bfd for static route,

The following configuration should be operated on all switches if the switch ID is not specified.

step 1 Enter the configure mode

```
Switch# configure terminal
```

step 2 Enter the interface configure mode and set the attributes of the interface

Interface configuration for Switch1:

```
Switch(config)# interface eth-0-11
Switch(config-if)# no switchport
Switch(config-if)# no shutdown
Switch(config-if)# ip address 11.11.11.1/24
Switch(config-if)# exit
```

Interface configuration for Switch2:

```
Switch(config)# interface eth-0-11
Switch(config-if)# no switchport
Switch(config-if)# no shutdown
Switch(config-if)# ip address 11.11.11.2/24
Switch(config-if)# exit

Switch(config)#interface eth-0-12
Switch(config-if)#no switchport
Switch(config-if)#no shutdown
```



```
Switch(config-if)#ip address 12.12.12.1/24
Switch(config-if)#exit
```

Interface configuration for Switch3:

```
Switch(config)# interface eth-0-12
Switch(config-if)#no switchport
Switch(config-if)#no shutdown
Switch(config-if)#ip address 12.12.12.2/24
Switch(config-if)#exit
```

step 3 Configuring static route

Configuring Switch1:

```
Switch1(config)#ip route 12.12.12.2/24 11.11.11.2
Switch1(config)# bfd test peer-ip 12.12.12.2 source-ip 11.11.11.1 local 10 remote
20
Switch1(config)# ip route 192.168.1.1/24 12.12.12.2 bind bfd test
```

Configuring Switch3:

```
Switch3(config)#ip route 11.11.11.1/24 12.12.12.1
Switch3(config)#bfd test peer-ip 11.11.11.1 source-ip 12.12.12.2 local 20 remote 10
Switch3(config)#ip route 2.2.2.2/24 11.11.11.1 bind bfd test
```

step 6 Exit configure mode

```
Switch(config)# end
```

step 7 Validation

Display Switch1 results:

```
Switch# show bfd session
abbreviation:
LD: local Discriminator.      RD: Discriminator
S: single hop session.       M: multi hop session.
SD: Static Discriminator.    DD: Dynamic Discriminator
A: Admin down.              D:down.      I:init.      U:up.
=====
LD  RD  TYPE ST  UP-Time  Remote-Addr  vrf
10  20  S-SD U    00:01:27  12.12.12.2  default
```

Display Switch3 results:

```
Switch# show bfd session
abbreviation:
LD: local Discriminator.      RD: Discriminator
S: single hop session.       M: multi hop session.
SD: Static Discriminator.    DD: Dynamic Discriminator
A: Admin down.              D:down.      I:init.      U:up.
=====
```

LD	RD	TYPE	ST	UP-Time	Remote-Addr	vrf
20	10	S-SD	U	00:01:27	11.11.11.1	default

16.14.3 Application cases

N/A

16.15 Configuring VARP

16.15.1 Overview

Function Introduction

Virtual ARP (VARP) allows multiple switches to simultaneously route packets with the same destination MAC address. Each switch is configured with the same virtual MAC address for the L3 interfaces configured with a virtual IP address. In MLAG configurations, VARP is preferred over VRRP because VARP working on active-active mode without traffic traverse peer link.

For ARP and GARP requests to virtual IP address, VARP will use the virtual MAC address to reply. The virtual MAC address is only used in the destination field of inbound packets and never used in the source field of outbound packets. Topology

Principle Description

N/A

16.15.2 Configuration

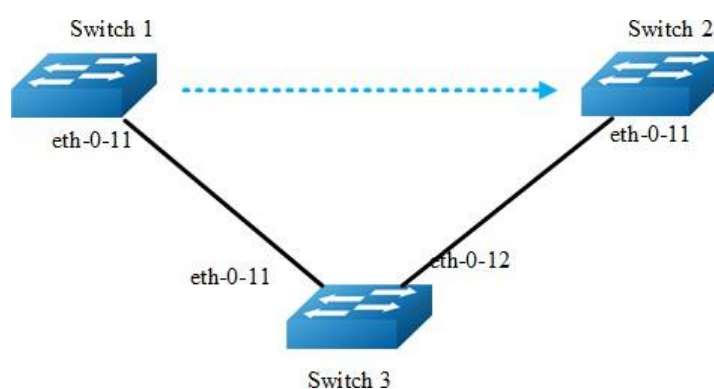

Figure 16-40 VARP with MALG

The following configuration should be operated on all devices if the device ID is not specified.

step 1 Enter the configure mode

```
Switch# configure terminal
```

step 2 Set the virtual-router mac address

```
Switch(config)# ip virtual-router mac a.a.a
```

step 3 Enter the vlan configure mode and create the vlan

```
Switch(config)# vlan database  
Switch(config-vlan)# vlan 2  
Switch(config-vlan)# exit
```

step 4 Enter the interface configure mode and set the attributes of the interface

```
Switch(config)# interface eth-0-11  
Switch(config-if)# switchport access vlan 2  
Switch(config-if)# no shutdown  
Switch(config-if)# exit
```

step 5 Create the vlan interface and set ip and virtual router ip**Configuring Switch1:**

```
Switch1(config)# interface vlan 2  
Switch1(config-if)# ip address 10.10.10.1/24  
Switch1(config-if)# ip virtual-router address 10.10.10.254  
Switch1(config-if)# exit
```

Configuring Switch2:

```
Switch2(config-if)# interface vlan 2  
Switch2(config-if)# ip address 10.10.10.2/24  
Switch2(config-if)# ip virtual-router address 10.10.10.254  
Switch2(config-if)# exit
```

step 6 Exit the configure mode

```
Switch(config)# end
```

step 7 Validation

Display the result on Switch1.

```
Switch1# show ip arp
Protocol      Address          Age (min)  Hardware Addr  Interface
Internet     10.10.10.1      -         cef0.12da.8100 vlan2
Internet     10.10.10.254   -         000a.000a.000a vlan2
```

Display the result on Switch2.

```
Switch2# show ip arp
Protocol      Address          Age (min)  Hardware Addr  Interface
Internet     10.10.10.2      -         66d1.4c26.e100 vlan2
Internet     10.10.10.254   -         000a.000a.000a vlan2
```

16.15.3 Application cases

N/A

16.16 Configuring UDP Helper

16.16.1 Overview

Function Introduction

The main function of UDP helper is to relay and forward the specified UDP message in IP broadcast packet, convert the specified UDP message in IP broadcast packet into unicast packet and send it to the specified server, it plays a role of relay.

After enabling the UDP helper function, the device will make a judgement on the destination port number of the received broadcast UDP packet. If the packet whose destination port number matches the port number configured by the UDP helper, it will copy it and modify the the destination IP address of packet header and sent to the designated server.

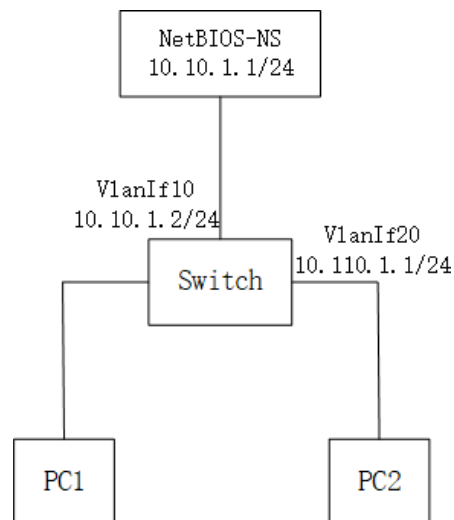

Figure 16-41 UDP-Helper configuration

The default 6 UDP destination port:

Protocol	UDP destination port	DNS (Domain Name System)	53	NetBIOS-DS (NetBIOS Datagram Service)	138	NetBIOS-NS (NetBIOS Name Service)	137	TACACS (Terminal Access Controller Access Control System)	49	TFTP (Trivial File Transfer Protocol)	69	Time Service	37
----------	----------------------	--------------------------	----	---------------------------------------	-----	-----------------------------------	-----	---	----	---------------------------------------	----	--------------	----

Principle Description

16.16.2 Configuration

step 1 Enter the configure mode

```
Switch# configure terminal
```

step 2 Enable UDP Helper

```
Switch(config)# ip udp-helper enable
```

step 3 Configure the IP address and UDP Helper Server IP address on interface

```
Switch(config)# vlan database
Switch(config-vlan)# vlan 10,20
Switch(config-vlan)# exit
Switch(config)# interface eth-0-1
Switch(config-if)# switchport mode access
Switch(config-if)# switchport access vlan 20
Switch(config-if)# exit
```

```
Switch(config)# interface eth-0-2
Switch(config-if)# switchport mode access
Switch(config-if)# switchport access vlan 10
Switch(config-if)# exit
Switch(config)# interface vlan 20
Switch(config-if)# ip address 10.110.1.1/24
Switch(config-if)# ip udp-helper server 10.10.1.1
Switch(config-if)# exit
Switch(config)# interface vlan 10
Switch(config-if)# ip address 10.10.1.2/24
```

step 4 configure the ARP

```
Switch(config)# arp 10.10.1.1 0.0.1
```

step 5 Exit the configure mode

```
Switch(config)# end
```

step 6 Validation

To display the UDP Helper configuration, use following privileged EXEC commands.

```
Switch# show ip udp-helper server
Interface      Server IP      Packet Received Packet Dropped
-----+-----+-----+-----
vlan20        10.10.1.1     0              0
```

16.16.3 Application cases

N/A

17 Network Virtualization Configuration Guide

17.1 Configuring VXLAN

17.1.1 Overview

Function Introduction

Virtual Extensible LAN (VXLAN) is a networking technology that encapsulates MAC-based Layer 2 Ethernet frames within Layer 3 UDP packets to aggregate and tunnel multiple layer 2 networks across a Layer 3 infrastructure. VXLAN scales up to 16 million logical networks and supports layer 2 adjacency across IP networks. Multicast transmission architecture is used for broadcast/multicast/unknown packets.

Principle Description

N/A

17.1.2 Configuration

Vxlan Configuration

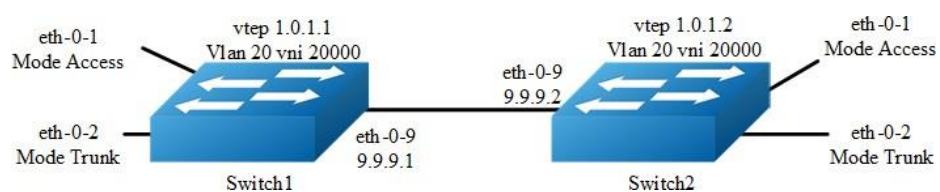

Figure 17-1 Vxlan

In the following example, switch1 and swith2 are connected via layer 3 route. The traffic of vlan 20 are encapsulated in vni 20000, in order to pass through the layer 3 networks.

The following configuration should be operated on all switches if the switch ID is not specified.

step 1 Enter the configure mode

```
Switch# configure terminal
```

step 2 Enter the vlan configure mode and create vlan, enable overlay for each vlan

```
Switch(config)# vlan database
Switch(config-vlan)# vlan 20
Switch(config-vlan)# vlan 20 overlay enable
Switch(config-vlan)# exit
```

step 3 Enter the interface configure mode and set the attributes of the interface

Interface configuration for Switch1:

```
Switch(config)# interface eth-0-1
Switch(config-if)# switchport access vlan 20
Switch(config-if)# no shutdown
Switch(config-if)# exit

Switch(config)# interface eth-0-2
Switch(config-if)# switchport mode trunk
Switch(config-if)# switchport trunk allowed vlan add 20
Switch(config-if)# no shutdown
Switch(config-if)# exit

Switch(config)# interface eth-0-9
Switch(config-if)# no switchport
Switch(config-if)# ip address 9.9.9.1/24
Switch(config-if)# overlay uplink enable
Switch(config-if)# no shutdown
Switch(config-if)# exit

Switch(config)# interface loopback0
Switch(config-if)# ip address 1.0.1.1/32
Switch(config-if)# exit
```

Interface configuration for Switch2:

```
Switch(config)# interface eth-0-1
Switch(config-if)# switchport access vlan 20
Switch(config-if)# no shutdown
Switch(config-if)# exit

Switch(config)# interface eth-0-2
Switch(config-if)# switchport mode trunk
Switch(config-if)# switchport trunk allowed vlan add 20
```



```
Switch(config-if) # no shutdown
Switch(config-if) # exit

Switch(config) # interface eth-0-9
Switch(config-if) # no switchport
Switch(config-if) # ip address 9.9.9.2/24
Switch(config-if) # overlay uplink enable
Switch(config-if) # no shutdown
Switch(config-if) # exit

Switch(config) # interface loopback0
Switch(config-if) # ip address 1.0.1.2/32
Switch(config-if) # exit
```

Step 4 Create a static route

Configuring Switch1:

```
Switch(config) # ip route 1.0.1.2/32 9.9.9.2
```

Configuring Switch2:

```
Switch(config) # ip route 1.0.1.1/32 9.9.9.1
```

Step 5 Set attributes for overlay

Configuring Switch1:

```
Switch(config) # overlay
Switch(config-overlay) # source 1.0.1.1
Switch(config-overlay) # remote-vtep 1 ip-address 1.0.1.2 type vxlan
Switch(config-overlay) # vlan 20 vni 20000
Switch(config-overlay) # vlan 20 remote-vtep 1
Switch(config-overlay) # exit
```

Configuring Switch2:

```
Switch(config) # overlay
Switch(config-overlay) # source 1.0.1.2
Switch(config-overlay) # remote-vtep 1 ip-address 1.0.1.1 type vxlan
Switch(config-overlay) # vlan 20 vni 20000
Switch(config-overlay) # vlan 20 remote-vtep 1
Switch(config-overlay) # exit
```

step 6 Exit the configure mode

```
Switch(config) # end
```

step 7 Validation

Display the result on Switch1:

```
Switch# show overlay vlan 20
```

```
-----
ECMP Mode       : Normal
Source VTEP     : 1.0.1.1
-----
```

```
VLAN ID         : 20
VNI             : 20000
EVPN Tunnel Data-fdb Learning : Enable
Remote VTEP NUM : 1
                Index: 1, Ip address: 1.0.1.2, Source ip: 1.0.1.1, Type: VxLAN, Protocol:
Static
DVR Gateway NUM: 0
-----
```

Display the result on Switch2:

```
Switch# show overlay vlan 20
```

```
-----
ECMP Mode       : Normal
Source VTEP     : 1.0.1.2
-----
```

```
VLAN ID         : 20
VNI             : 20000
EVPN Tunnel Data-fdb Learning : Enable
Remote VTEP NUM : 1
                Index: 1, Ip address: 1.0.1.1, Source ip: 1.0.1.2, Type: VxLAN, Protocol:
Static
DVR Gateway NUM: 0
-----
```

Configuring VXLAN Routing

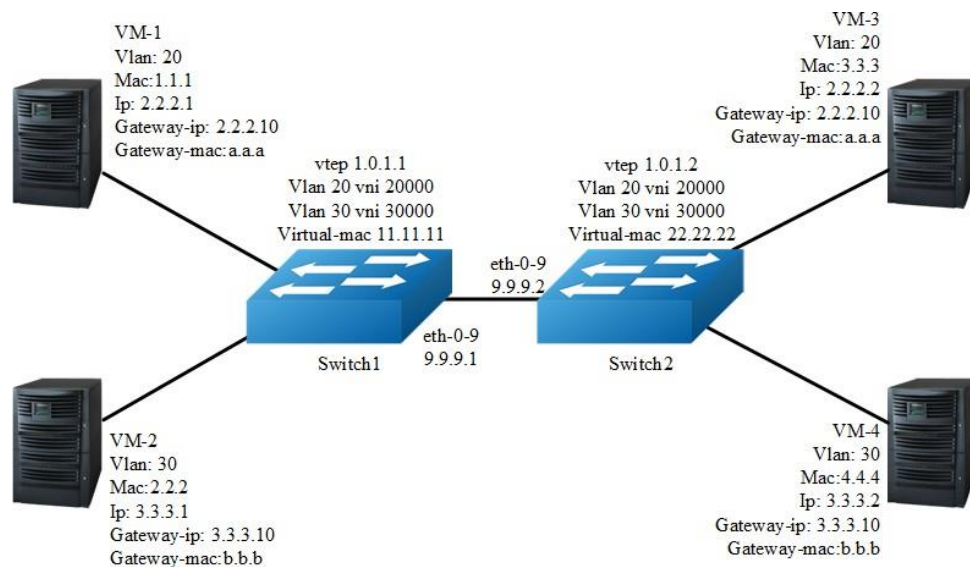

Figure 17-2 Vxlan

In the following example, VM-1 & VM-3 are encapsulated in same vni to make up the distributed route via vxlan; VM-2 & VM-4 are encapsulated in another vni to make up the distributed route via vxlan.

The following configuration should be operated on all switches if the switch ID is not specified.

step 1 Enter the configure mode

```
Switch# configure terminal
```

step 2 Enter the vlan configure mode and create vlan, enable overlay for each vlan

```
Switch(config)# vlan database
Switch(config-vlan)# vlan 20,30
Switch(config-vlan)# vlan 20 overlay enable
Switch(config-vlan)# vlan 30 overlay enable
Switch(config-vlan)# exit
```

step 3 Create a vrf instance

```
Switch(config)# ip vrf tenant
Switch(config-vrf)# exit
```

step 4 Create the layer 3 interface and set the ip address

Configuring Switch1:

```
Switch(config)# interface vlan 20
Switch(config-if)# ip vrf forwarding tenant
Switch(config-if)# ip address 2.2.2.111/24
Switch(config-if)# exit

Switch(config)# interface vlan 30
Switch(config-if)# ip vrf forwarding tenant
Switch(config-if)# ip address 3.3.3.111/24
Switch(config-if)# exit
```

Configuring Switch2:

```
Switch(config)# interface vlan 20
Switch(config-if)# ip vrf forwarding tenant
Switch(config-if)# ip address 2.2.2.222/24
Switch(config-if)# exit

Switch(config)# interface vlan 30
Switch(config-if)# ip vrf forwarding tenant
```

```
Switch(config-if)# ip address 3.3.3.222/24
Switch(config-if)# exit
```

step 5 Enter the interface configure mode and set the attributes of the interface

```
Switch(config)# interface eth-0-1
Switch(config-if)# switchport mode trunk
Switch(config-if)# switchport trunk allowed vlan add 20
Switch(config-if)# no shutdown
Switch(config-if)# exit

Switch(config)# interface eth-0-2
Switch(config-if)# switchport mode trunk
Switch(config-if)# switchport trunk allowed vlan add 30
Switch(config-if)# no shutdown
Switch(config-if)# exit
```

Configuring Switch1:

```
Switch(config)# interface eth-0-9
Switch(config-if)# no switchport
Switch(config-if)# ip address 9.9.9.1/24
Switch(config-if)# overlay uplink enable
Switch(config-if)# no shutdown
Switch(config-if)# exit

Switch(config)# interface loopback0
Switch(config-if)# ip address 1.0.1.1/32
Switch(config-if)# exit
```

Configuring Switch2:

```
Switch(config)# interface eth-0-9
Switch(config-if)# no switchport
Switch(config-if)# ip address 9.9.9.2/24
Switch(config-if)# overlay uplink enable
Switch(config-if)# no shutdown
Switch(config-if)# exit

Switch(config)# interface loopback0
Switch(config-if)# ip address 1.0.1.2/32
Switch(config-if)# exit
```

Step 6 Set attributes for overlay

Configuring Switch1:

```
Switch(config)# overlay
Switch(config-overlay)# source 1.0.1.1
Switch(config-overlay)# remote-vtep 1 ip-address 1.0.1.2 type vxlan
Switch(config-overlay)# remote-vtep 1 virtual-mac 22.22.22
Switch(config-overlay)# vlan 20 vni 20000
Switch(config-overlay)# vlan 30 vni 30000
Switch(config-overlay)# vlan 20 remote-vtep 1
```

```
Switch(config-overlay)# vlan 30 remote-vtep 1
Switch(config-overlay)# vlan 20 gateway-mac a.a.a
Switch(config-overlay)# vlan 30 gateway-mac b.b.b
Switch(config-overlay)# exit
```

Configuring Switch2:

```
Switch(config)# overlay
Switch(config-overlay)# source 1.0.1.2
Switch(config-overlay)# remote-vtep 1 ip-address 1.0.1.1 type vxlan
Switch(config-overlay)# remote-vtep 1 virtual-mac 11.11.11
Switch(config-overlay)# vlan 20 vni 20000
Switch(config-overlay)# vlan 30 vni 30000
Switch(config-overlay)# vlan 20 remote-vtep 1
Switch(config-overlay)# vlan 30 remote-vtep 1
Switch(config-overlay)# vlan 20 gateway-mac a.a.a
Switch(config-overlay)# vlan 30 gateway-mac b.b.b
Switch(config-overlay)# exit
```

step 7 Create a static routes and vxlan routes

Configuring Switch1:

```
Switch(config)# ip route 1.0.1.2/32 9.9.9.2
Switch(config)# ip route vrf tenant 2.2.2.2/32 remote-vtep 1 vni 20000 inner-macda
3.3.3
Switch(config)# ip route vrf tenant 3.3.3.2/32 remote-vtep 1 vni 30000 inner-macda
4.4.4
```

Configuring Switch2:

```
Switch(config)# ip route 1.0.1.1/32 9.9.9.1
Switch(config)# ip route vrf tenant 2.2.2.1/32 remote-vtep 1 vni 20000 inner-macda
1.1.1
Switch(config)# ip route vrf tenant 3.3.3.1/32 remote-vtep 1 vni 30000 inner-macda
2.2.2
```

step 8 Exit the configure mode

```
Switch(config)# end
```

step 9 Validation

Display the result on Switch1:

```
Switch# show ip route vrf tenant
Codes: K - kernel, C - connected, S - static, R - RIP, B - BGP
       O - OSPF, IA - OSPF inter area
       N1 - OSPF NSSA external type 1, N2 - OSPF NSSA external type 2
       E1 - OSPF external type 1, E2 - OSPF external type 2
       i - IS-IS, L1 - IS-IS level-1, L2 - IS-IS level-2, ia - IS-IS inter area
       Dc - DHCP Client
       [*] - [AD/Metric]
```

```
* - candidate default
S      2.2.2.2/32 is in overlay remote vxlan vtep:1.0.1.1->1.0.1.2, vni:20000
S      3.3.3.2/32 is in overlay remote vxlan vtep:1.0.1.1->1.0.1.2, vni:30000
```

Display the result on Switch2:

```
Switch# show ip route vrf tenant
Codes: K - kernel, C - connected, S - static, R - RIP, B - BGP
       O - OSPF, IA - OSPF inter area
       N1 - OSPF NSSA external type 1, N2 - OSPF NSSA external type 2
       E1 - OSPF external type 1, E2 - OSPF external type 2
       i - IS-IS, L1 - IS-IS level-1, L2 - IS-IS level-2, ia - IS-IS inter area
       Dc - DHCP Client
       [*] - [AD/Metric]
       * - candidate default
S      2.2.2.1/32 is in overlay remote vxlan vtep:1.0.1.2->1.0.1.1, vni:20000
S      3.3.3.1/32 is in overlay remote vxlan vtep:1.0.1.2->1.0.1.1, vni:30000
```

Configuring VXLAN Distributed Routing by EBGp EVPN

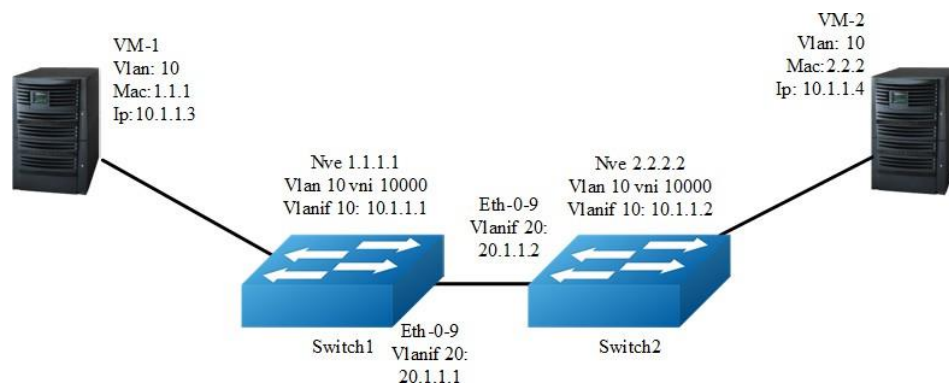

Figure 17-3 EBGp_EVPN

In the following example, VM-1 & VM-2 are encapsulated in same vni to make up the distributed route via vxlan by EBGp EVPN for sending vxlan tunnel and host information;

The following configuration should be operated on all switches if the switch ID is not specified.

step 1 Enter the configure mode

```
Switch# configure terminal
```

step 2 Enter the vlan configure mode and create vlan, enable overlay for each vlan

```
Switch(config)# vlan database
Switch(config-vlan)# vlan 10, 20
Switch(config-vlan)# vlan 10 overlay enable
Switch(config-vlan)# exit
```

option: enable arp broadcast suppress for vlan

```
Switch(config-vlan)# vlan 10 arp-broadcast-suppress enable
```

step 3 Create vlan mapping vni for vxlan

```
Switch(config)# overlay
Switch(config-overlay)# vlan 10 vni 10000
Switch(config-vlan)# exit
```

option: Disable inner fdb learning for overlay

```
Switch(config-overlay)# vlan 10 mac-address-tunnel learning-disable
```

step 4 Create evpn instance

```
Switch(config)# evpn
Switch(config-evpn)# vni 10000
Switch(config-evi)# rd auto
Switch(config-evi)# route-target both 1:10000
Switch(config-evi)# exit
```

step 5 Create a vrf instance, and enable EVPN

Configuring Switch1:

```
Switch1(config)# ip vrf tenant
Switch1(config-vrf)# rd 1:20000
Switch1(config-vrf)# route-target both 1:10000 evpn
Switch1(config-vrf)# vxlan vni 20000
Switch1(config-vrf)# exit
```

Configuring Switch2:

```
Switch2(config)# ip vrf tenant
Switch2(config-vrf)# rd 2:20000
Switch2(config-vrf)# route-target both 1:10000 evpn
Switch2(config-vrf)# vxlan vni 20000
Switch2(config-vrf)# exit
```

step 6 Create the layer 3 interface , set the ip address and enable distributed gateway

Configuring Switch1:

```
Switch1(config)# interface vlan 10
Switch1(config-if)# ip vrf forwarding tenant
Switch1(config-if)# overlay distributed-gateway enable
Switch1(config-if)# overlay host-collect enable
Switch1(config-if)# ip address 10.1.1.1/24
Switch1(config-if)# exit
Switch1(config)# interface vlan 20
Switch1(config-if)# ip address 20.1.1.1/24
Switch1(config-if)# exit
```

Configuring Switch2:

```
Switch2(config)# interface vlan 10
Switch2(config-if)# ip vrf forwarding tenant
Switch2(config-if)# overlay distributed-gateway enable
Switch2(config-if)# overlay host-collect enable
Switch2(config-if)# ip address 10.1.1.2/24
Switch2(config-if)# exit
Switch2(config)# interface vlan 20
Switch2(config-if)# ip address 20.1.1.2/24
Switch2(config-if)# exit
```

step 7 Enter the interface configure mode and set the attributes of the interface

```
Switch(config)# interface eth-0-1
Switch(config-if)# switchport access vlan 10
Switch(config-if)# no shutdown
Switch(config-if)# exit
Switch(config)# interface eth-0-9
Switch(config-if)# switchport mode trunk
Switch(config-if)# switchport trunk allowed vlan add 20
Switch(config-if)# vxlan uplink enable
Switch(config-if)# no shutdown
Switch(config-if)# exit
```

Step 8 Create NVE

Configuring Switch1:

```
Switch1(config)# interface loopback 1
Switch1(config-if)# ip address 1.1.1.1/32
Switch1(config-if)# exit
Switch1(config)# interface nve 1
Switch1(config-if)# source loopback 1
Switch1(config-if)# member vni 10000
Switch1(config-if)# member vni 20000 associate-vrf
Switch1(config-if)# exit
```

Configuring Switch2:

```
Switch2(config)# interface loopback 1
Switch2(config-if)# ip address 2.2.2.2/32
Switch2(config-if)# exit
Switch2(config)# interface nve 1
Switch2(config-if)# source loopback 1
Switch2(config-if)# member vni 10000
Switch2(config-if)# member vni 20000 associate-vrf
Switch2(config-if)# exit
```

option: configure the attribute of EVPN tunnel

```
Switch(config-if)# keep-vlan-tag enable
Switch(config-if)# split-horizon disable
Switch(config-if)# encapsulation-dscp-strategy custom-assign 63
Switch(config-if)# virtual-mac a.a.a
```

Step 9 Create BGP EVPN

Configuring Switch1:

```
Switch1(config)# router bgp 100
Switch1(config-router)# neighbor 20.1.1.2 remote-as 200
Switch1(config-router)# address-family l2vpn evpn
Switch1(config-router-af)# neighbor 20.1.1.2 activate
Switch1(config-router-af)# neighbor 20.1.1.2 send-community extended
Switch1(config-router-af)# neighbor 20.1.1.2 attribute-unchanged next-hop
Switch1(config-router-af)# exit
Switch1(config-router)# exit
```

Configuring Switch2:

```
Switch2(config)# router bgp 200
Switch2(config-router)# neighbor 20.1.1.1 remote-as 100
Switch2(config-router)# address-family l2vpn evpn
Switch2(config-router-af)# neighbor 20.1.1.1 activate
Switch2(config-router-af)# neighbor 20.1.1.1 send-community extended
Switch2(config-router-af)# neighbor 20.1.1.1 attribute-unchanged next-hop
Switch2(config-router-af)# exit
Switch2(config-router)# exit
```

step 10 Create a static routes

Configuring Switch1:

```
Switch1(config)# ip route 2.2.2.2/32 20.1.1.2
```

Configuring Switch2:

```
Switch(config2)# ip route 1.1.1.1/32 20.1.1.1
```

step 11 Exit the configure mode

```
Switch(config)# end
```

step 12 Validation

Display the result on Switch1:

```
Switch1# show bgp evpn all
Status codes: s suppressed, d damped, h history, * valid, > best, i - internal,
              S Stale
Origin codes: i - IGP, e - EGP, ? - incomplete

   Network                Next Hop           Metric LocPrf Weight Path
Route Distinguisher: 1:10000 (L2VNI 10000)
*> [2]:[0]:[48]:[4623.28ef.da00]:[32]:[0.0.0.0]/136
      1.1.1.1                                32768 i
*> [2]:[0]:[48]:[4623.28ef.da00]:[32]:[10.1.1.3]/136
      1.1.1.1                                32768 i
*> [2]:[0]:[48]:[ac7f.1cc5.fe00]:[32]:[0.0.0.0]/136
      2.2.2.2                                 0 200 i
*> [2]:[0]:[48]:[ac7f.1cc5.fe00]:[32]:[10.1.1.4]/136
      2.2.2.2                                 0 200 i
*> [3]:[0]:[32]:[1.1.1.1]/80
      1.1.1.1                                32768 i
*> [3]:[0]:[32]:[10.20.30.40]/80
      2.2.2.2                                 0 200 i

Route Distinguisher: 1:10000
*> [2]:[0]:[48]:[ac7f.1cc5.fe00]:[32]:[0.0.0.0]/136
      2.2.2.2                                 0 200 i
*> [2]:[0]:[48]:[ac7f.1cc5.fe00]:[32]:[10.1.1.4]/136
      2.2.2.2                                 0 200 i
*> [3]:[0]:[32]:[2.2.2.2]/80
      2.2.2.2                                 0 200 i

Route Distinguisher: 1:20000 (L3VNI 20000)
*> [2]:[0]:[48]:[ac7f.1cc5.fe00]:[32]:[10.1.1.4]/136
      2.2.2.2

Switch1# show overlay tunnel
-----
Vlan Vni      Type  Remote-vtep IP-Address      Src-Address      Head-end-
flooding Protocol
10   10000    VxLAN  0           2.2.2.2         1.1.1.1          Enable
Evpn
```

Display the result on Switch2:

```
Head-end-floodingSwitch2# show bgp evpn all
Status codes: s suppressed, d damped, h history, * valid, > best, i - internal,
              S Stale
Origin codes: i - IGP, e - EGP, ? - incomplete
```

```

      Network      Next Hop      Metric LocPrf Weight Path
Route Distinguisher: 1:10000 (L2VNI 10000)
*> [2]:[0]:[48]:[4623.28ef.da00]:[32]:[0.0.0.0]/136
      1.1.1.1
                                     0 100 i
*> [2]:[0]:[48]:[4623.28ef.da00]:[32]:[10.1.1.3]/136
      1.1.1.1
                                     0 100 i
*> [2]:[0]:[48]:[ac7f.1cc5.fe00]:[32]:[0.0.0.0]/136
      2.2.2.2
                                     32768 i
*> [2]:[0]:[48]:[ac7f.1cc5.fe00]:[32]:[10.1.1.4]/136
      2.2.2.2
                                     32768 i
*> [3]:[0]:[32]:[1.1.1.1]/80
      1.1.1.1
                                     0 100 i
*> [3]:[0]:[32]:[2.2.2.2]/80
      2.2.2.2
                                     32768 i

Route Distinguisher: 1:10000
*> [2]:[0]:[48]:[4623.28ef.da00]:[32]:[0.0.0.0]/136
      1.1.1.1
                                     0 100 i
*> [2]:[0]:[48]:[4623.28ef.da00]:[32]:[10.1.1.3]/136
      1.1.1.1
                                     0 100 i
*> [3]:[0]:[32]:[1.1.1.1]/80
      1.1.1.1
                                     0 100 i

Route Distinguisher: 2:20000 (L3VNI 20000)
*> [2]:[0]:[48]:[4623.28ef.da00]:[32]:[10.1.1.3]/136
      1.1.1.1
                                     0 100 i

Switch2# show overlay tunnel
-----
Vlan Vni      Type   Remote-vtep IP-Address      Src-Address      Head-end-
flooding Protocol
10   10000    VxLAN  0              1.1.1.1         2.2.2.2         Enable
Evpn

```

Configuring VXLAN Distributed Routing by IBGP EVPN

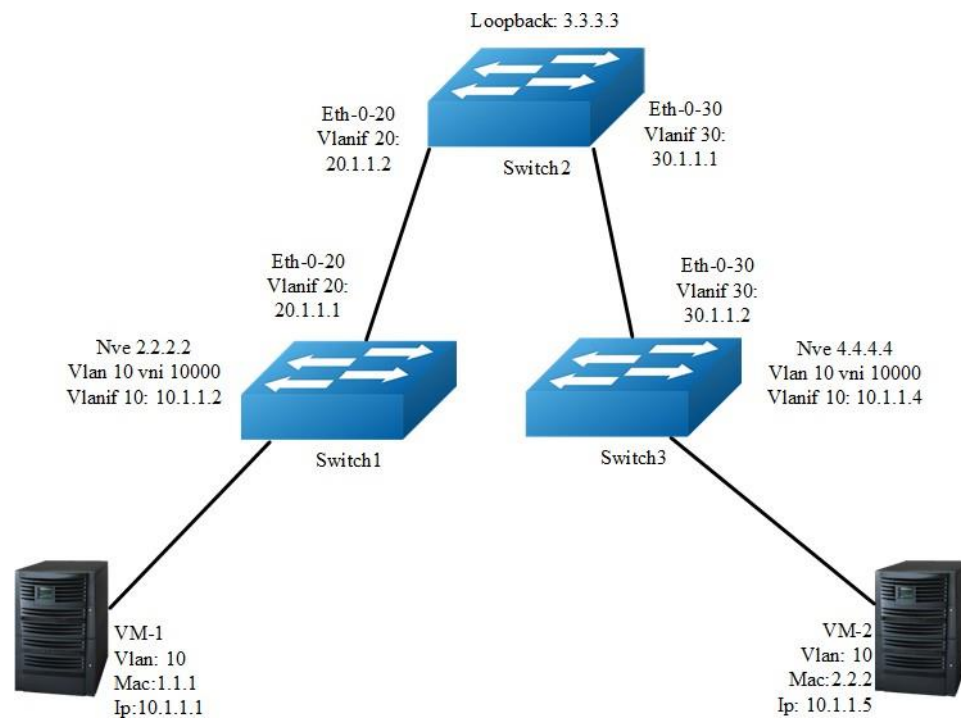

Figure 17-4 IBGP_EVPN

In the following example, VM-1 & VM-2 are encapsulated in same vni to make up the distributed route via vxlan by IBGP EVPN for sending vxlan tunnel and host information;EVPN route is exchanged by bgp route reflector.

The following configuration should be operated on all switches if the switch ID is not specified.

step 1 Enter the configure mode

```
Switch# configure terminal
```

step 2 Enter the vlan configure mode and create vlan, enable overlay for each vlan

Configuring Switch1:

```
Switch1(config)# vlan database
Switch1(config-vlan)# vlan 10, 20
Switch1(config-vlan)# vlan 10 overlay enable
Switch1(config-vlan)# exit
```

Configuring Switch2:

```
Switch2(config)# vlan database
Switch2(config-vlan)# vlan 20, 30
Switch2(config-vlan)# exit
```

Configuring Switch3:

```
Switch3(config)# vlan database
Switch3(config-vlan)# vlan 10, 30
Switch3(config-vlan)# vlan 10 overlay enable
Switch3(config-vlan)# exit
```

option: enable arp broadcast suppress for vlan

```
Switch(config-vlan)# vlan 10 arp-broadcast-suppress enable
```

step 3 Create vlan mapping vni for vxlan

Configuring Switch1:

```
Switch1(config)# overlay
Switch1(config-overlay)# vlan 10 vni 10000
Switch1(config-vlan)# exit
```

option: Disable inner fdb learning for overlay

```
Switch1(config-overlay)# vlan 10 mac-address-tunnel learning-disable
```

Configuring Switch3:

```
Switch3(config)# overlay
Switch3(config-overlay)# vlan 10 vni 10000
Switch3(config-vlan)# exit
```

option: Disable inner fdb learning for overlay

```
Switch3(config-overlay)# vlan 10 mac-address-tunnel learning-disable
```

step 4 Create evpn instance

Configuring Switch1:

```
Switch1(config)# evpn
Switch1(config-evpn)# vni 10000
Switch1(config-evi)# rd 2:2
Switch1(config-evi)# route-target both 20:20
Switch1(config-evi)# exit
```

Configuring Switch2:

```
Switch2(config)# evpn
```

Configuring Switch3:

```
Switch3(config)# evpn
Switch3(config-evpn)# vni 10000
Switch3(config-evi)# rd 4:4
Switch3(config-evi)# route-target both 20:20
Switch3(config-evi)# exit
```

step 5 Create a vrf instance, and enable EVPN

Configuring Switch1:

```
Switch1(config)# ip vrf tenant
Switch1(config-vrf)# rd 22:22
Switch1(config-vrf)# route-target both 20:20 evpn
Switch1(config-vrf)# vxlan vni 20000
Switch1(config-vrf)# exit
```

在 switch3 配置:

Configuring Switch3:

```
Switch3(config)# ip vrf tenant
Switch3(config-vrf)# rd 44:44
Switch3(config-vrf)# route-target both 20:20 evpn
Switch3(config-vrf)# vxlan vni 20000
Switch3(config-vrf)# exit
```

step 6 Create the layer 3 interface , set the ip address and enable distributed gateway

Configuring Switch1:

```
Switch1(config)# interface vlan 10
Switch1(config-if)# ip vrf forwarding tenant
Switch1(config-if)# overlay distributed-gateway enable
Switch1(config-if)# overlay host-collect enable
Switch1(config-if)# ip address 10.1.1.2/24
Switch1(config-if)# exit
Switch1(config)# interface vlan 20
Switch1(config-if)# ip address 20.1.1.1/24
Switch1(config-if)# exit
```

Configuring Switch2:

```
Switch2(config)# interface vlan 20
Switch2(config-if)# ip address 20.1.1.2/24
Switch2(config-if)# exit
Switch2(config)# interface vlan 30
Switch2(config-if)# ip address 30.1.1.1/24
Switch2(config-if)# exit
```

Configuring Switch3:

```
Switch3(config)# interface vlan 10
Switch3(config-if)# ip vrf forwarding tenant
Switch3(config-if)# overlay distributed-gateway enable
Switch3(config-if)# overlay host-collect enable
Switch3(config-if)# ip address 10.1.1.3/24
Switch3(config-if)# exit
Switch3(config)# interface vlan 30
Switch3(config-if)# ip address 30.1.1.2/24
Switch3(config-if)# exit
```

step 7 Enter the interface configure mode and set the attributes of the interface

Configuring Switch1:

```
Switch1(config)# interface eth-0-10
Switch1(config-if)# switchport access vlan 10
Switch1(config-if)# no shutdown
Switch1(config-if)# exit
Switch1(config)# interface eth-0-20
Switch1(config-if)# switchport mode trunk
Switch1(config-if)# switchport trunk allowed vlan add 20
Switch1(config-if)# vxlan uplink enable
Switch1(config-if)# no shutdown
Switch1(config-if)# exit
```

Configuring Switch2:

```
Switch2(config)# interface eth-0-20
Switch2(config-if)# switchport mode trunk
Switch2(config-if)# switchport trunk allowed vlan add 20
Switch2(config-if)# vxlan uplink enable
Switch2(config-if)# no shutdown
Switch2(config-if)# exit
Switch2(config)# interface eth-0-30
Switch2(config-if)# switchport mode trunk
Switch2(config-if)# switchport trunk allowed vlan add 30
Switch2(config-if)# vxlan uplink enable
Switch2(config-if)# no shutdown
Switch2(config-if)# exit
```

Configuring Switch3:

```
Switch3(config)# interface eth-0-10
Switch3(config-if)# switchport access vlan 10
Switch3(config-if)# no shutdown
Switch3(config-if)# exit
Switch3(config)# interface eth-0-30
Switch3(config-if)# switchport mode trunk
Switch3(config-if)# switchport trunk allowed vlan add 30
Switch3(config-if)# vxlan uplink enable
Switch3(config-if)# no shutdown
Switch3(config-if)# exit
```

Step 8 Create NVE

Configuring Switch1:

```
Switch1(config)# interface loopback 2
Switch1(config-if)# ip address 2.2.2.2/32
Switch1(config-if)# exit
Switch1(config)# interface nve 1
Switch1(config-if)# source 2.2.2.2
Switch1(config-if)# member vni 10000
Switch1(config-if)# member vni 20000 associate-vrf
Switch1(config-if)# exit
```

Configuring Switch2:

```
Switch2(config)# interface loopback 3
Switch2(config-if)# ip address 3.3.3.3/32
Switch2(config-if)# exit
```

Configuring Switch3:

```
Switch3(config)# interface loopback 4
Switch3(config-if)# ip address 4.4.4.4/32
Switch3(config-if)# exit
Switch3(config)# interface nve 1
Switch3(config-if)# source 4.4.4.4
Switch3(config-if)# member vni 10000
Switch3(config-if)# member vni 20000 associate-vrf
Switch3(config-if)# exit
```

option: configure the attribute of EVPN tunnel

```
Switch(config-if)# keep-vlan-tag enable
Switch(config-if)# split-horizon disable
Switch(config-if)# encapsulation-dscp-strategy custom-assign 63
Switch(config-if)# virtual-mac a.a.a
```

Step 9 Create BGP EVPN

Configuring Switch1:

```
Switch1(config)# router bgp 100
Switch1(config-router)# neighbor 3.3.3.3 remote-as 100
Switch1(config-router)# neighbor 3.3.3.3 update-source loopback2
Switch1(config-router)# neighbor 20.1.1.2 remote-as 100
Switch1(config-router)# address-family ipv4
Switch1(config-router-af)# network 2.2.2.2 mask 255.255.255.255
Switch1(config-router-af)# neighbor 20.1.1.2 weight 32768
Switch1(config-router-af)# exit
Switch1(config-router)# address-family l2vpn evpn
Switch1(config-router-af)# neighbor 3.3.3.3 activate
Switch1(config-router-af)# neighbor 3.3.3.3 send-community extended
Switch1(config-router-af)# exit
Switch1(config-router)# exit
```

Configuring Switch2:

```
Switch2(config)# router bgp 100
Switch2(config-router)# neighbor 2.2.2.2 remote-as 100
Switch2(config-router)# neighbor 2.2.2.2 update-source loopback3
Switch2(config-router)# neighbor 4.4.4.4 remote-as 100
Switch2(config-router)# neighbor 4.4.4.4 update-source loopback3
Switch2(config-router)# neighbor 20.1.1.1 remote-as 100
Switch2(config-router)# neighbor 30.1.1.2 remote-as 100
Switch2(config-router)# address-family ipv4
Switch2(config-router-af)# network 3.3.3.3 mask 255.255.255.255
Switch2(config-router-af)# network 20.1.1.0 mask 255.255.255.0
Switch2(config-router-af)# network 30.1.1.0 mask 255.255.255.0
Switch2(config-router-af)# neighbor 20.1.1.1 weight 32768
Switch2(config-router-af)# neighbor 20.1.1.1 route-reflector-client
Switch2(config-router-af)# neighbor 20.1.1.1 next-hop-self
Switch2(config-router-af)# neighbor 30.1.1.2 weight 32768
Switch2(config-router-af)# neighbor 30.1.1.2 route-reflector-client
Switch2(config-router-af)# neighbor 30.1.1.2 next-hop-self
Switch2(config-router-af)# exit
Switch2(config-router)# address-family l2vpn evpn
Switch2(config-router-af)# neighbor 2.2.2.2 activate
Switch2(config-router-af)# neighbor 2.2.2.2 route-reflector-client
Switch2(config-router-af)# neighbor 2.2.2.2 send-community extended
Switch2(config-router-af)# neighbor 4.4.4.4 activate
Switch2(config-router-af)# neighbor 4.4.4.4 route-reflector-client
Switch2(config-router-af)# neighbor 4.4.4.4 send-community extended
Switch2(config-router-af)# exit
Switch2(config-router)# exit
```

Configuring Switch3:

```
Switch3(config)# router bgp 100
Switch3(config-router)# neighbor 3.3.3.3 remote-as 100
Switch3(config-router)# neighbor 3.3.3.3 update-source loopback4
Switch3(config-router)# neighbor 30.1.1.1 remote-as 100
Switch3(config-router)# address-family ipv4
Switch3(config-router-af)# network 4.4.4.4 mask 255.255.255.255
Switch3(config-router-af)# neighbor 30.1.1.1 weight 32768
Switch3(config-router-af)# exit
Switch3(config-router)# address-family l2vpn evpn
Switch3(config-router-af)# neighbor 3.3.3.3 activate
Switch3(config-router-af)# neighbor 3.3.3.3 send-community extended
Switch3(config-router-af)# exit
Switch3(config-router)# exit
```

step 10 Exit the configure mode

```
Switch(config)# end
```

step 11 Validation

Display the result on Switch1:

```
Switch1# show bgp evpn all
Status codes: s suppressed, d damped, h history, * valid, > best, i - internal,
              S Stale
Origin codes: i - IGP, e - EGP, ? - incomplete

   Network                Next Hop                Metric LocPrf Weight Path
Route Distinguisher: 2:2 (L2VNI 10000)
*> [2]:[0]:[48]:[988b.123a.4000]:[32]:[0.0.0.0]/136
                2.2.2.2                                32768 i
*> [2]:[0]:[48]:[988b.123a.4000]:[32]:[10.1.1.1]/136
                2.2.2.2                                32768 i
*> [3]:[0]:[32]:[2.2.2.2]/80
                2.2.2.2                                32768 i
*>i[3]:[0]:[32]:[4.4.4.4]/80
                4.4.4.4                                100      0 i

Route Distinguisher: 4:4
*>i[3]:[0]:[32]:[4.4.4.4]/80
                4.4.4.4                                100      0 i

Switch1# show overlay tunnel
-----
Vlan Vni      Type   Remote-vtep IP-Address      Src-Address      Head-end-
flooding Protocol
10   10000    VxLAN  0             4.4.4.4         2.2.2.2         Enable
Evpn
```

Display the result on Switch2:

```
Switch2# show bgp evpn all
Status codes: s suppressed, d damped, h history, * valid, > best, i - internal,
              S Stale
Origin codes: i - IGP, e - EGP, ? - incomplete

   Network                Next Hop                Metric LocPrf Weight Path
Route Distinguisher: 2:2
*>i[2]:[0]:[48]:[988b.123a.4000]:[32]:[0.0.0.0]/136
                2.2.2.2                                100      0 i
*>i[2]:[0]:[48]:[988b.123a.4000]:[32]:[10.1.1.1]/136
                2.2.2.2                                100      0 i
*>i[3]:[0]:[32]:[2.2.2.2]/80
                2.2.2.2                                100      0 i

Route Distinguisher: 4:4
*>i[3]:[0]:[32]:[4.4.4.4]/80
                4.4.4.4                                100      0 i
```

Display the result on Switch3:

```
Switch3# show bgp evpn all
Status codes: s suppressed, d damped, h history, * valid, > best, i - internal,
              S Stale
Origin codes: i - IGP, e - EGP, ? - incomplete

   Network                Next Hop                Metric LocPrf Weight Path
```

```

Route Distinguisher: 2:2
*>i[2]:[0]:[48]:[988b.123a.4000]:[32]:[0.0.0.0]/136
      2.2.2.2                100      0 i
*>i[2]:[0]:[48]:[988b.123a.4000]:[32]:[10.1.1.1]/136
      2.2.2.2                100      0 i
*>i[3]:[0]:[32]:[2.2.2.2]/80
      2.2.2.2                100      0 i

Route Distinguisher: 4:4 (L2VNI 10000)
*>i[2]:[0]:[48]:[988b.123a.4000]:[32]:[0.0.0.0]/136
      2.2.2.2                100      0 i
*>i[2]:[0]:[48]:[988b.123a.4000]:[32]:[10.1.1.1]/136
      2.2.2.2                100      0 i
*>i[3]:[0]:[32]:[2.2.2.2]/80
      2.2.2.2                100      0 i
*> [3]:[0]:[32]:[4.4.4.4]/80
      4.4.4.4                32768 i

Route Distinguisher: 44:44 (L3VNI 20000)
*>i[2]:[0]:[48]:[988b.123a.4000]:[32]:[10.1.1.1]/136
      2.2.2.2                100      0 i

Switch3# show overlay tunnel
-----
Vlan Vni      Type   Remote-vtep IP-Address      Src-Address      Head-end-
flooding Protocol
10  10000    VxLAN  0             2.2.2.2         4.4.4.4          Enable
Evpn

Switch3# show mac address-table
      Mac Address Table
-----
(*) - Security Entry      (M) - MLAG Entry
(MO) - MLAG Output Entry  (MI) - MLAG Input Entry
Vlan   Mac Address      Type           Ports
-----
30     fcc0.9318.0a00   dynamic        eth-0-9
10     988b.123a.4000   dynamic        VxLAN: 4.4.4.4->2.2.2.2 (EI)

Switch3# show ip route vrf tenant
Codes: K - kernel, C - connected, S - static, R - RIP, B - BGP
O - OSPF, IA - OSPF inter area
N1 - OSPF NSSA external type 1, N2 - OSPF NSSA external type 2
E1 - OSPF external type 1, E2 - OSPF external type 2
i - IS-IS, L1 - IS-IS level-1, L2 - IS-IS level-2, ia - IS-IS inter area
Dc - DHCP Client
[*] - [AD/Metric]
* - candidate default

C      10.1.1.0/24 is directly connected, vlan10
C      10.1.1.3/32 is in local loopback, vlan10
B      10.1.1.1/32 is in overlay remote vxlan vtep:4.4.4.4->2.2.2.2, vni:20000

```

17.2 Configuring NVGRE

17.2.1 Overview

Function Introduction

Network Virtualization using Generic Routing Encapsulation (NVGRE) is an encapsulation technique intended to allow virtual network overlays across the physical network. NVGRE uses Generic Routing Encapsulation (GRE) as the encapsulation method. It uses the lower 24 bits of the GRE header to represent the Tenant Network Identifier (TNI.) Like VXLAN this 24 bit space allows for 16 million virtual networks.

Principle Description

N/A

17.2.2 Configuration

NVGRE Configuration

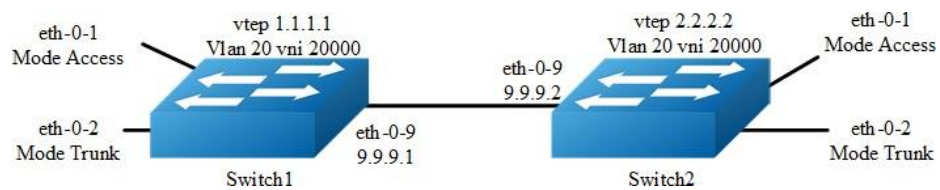

Figure 17-5 NVGRE

In the following example, switch1 and switch2 are connected via layer 3 route. The traffic of vlan 20 are encapsulated in vni 20000, in order to pass through the layer 3 networks.

The following configuration should be operated on all switches if the switch ID is not specified.

step 1 Enter the configure mode

```
Switch# configure terminal
```

step 2 Enter the vlan configure mode and create vlan, enable overlay for each vlan

```
Switch(config)# vlan database
Switch(config-vlan)# vlan 20
Switch(config-vlan)# vlan 20 overlay enable
Switch(config-vlan)# exit
```

step 3 Enter the interface configure mode and set the attributes of the interface

```
Switch(config)# interface eth-0-1
Switch(config-if)# switchport access vlan 20
Switch(config-if)# no shutdown
Switch(config-if)# exit

Switch(config)# interface eth-0-2
Switch(config-if)# switchport mode trunk
Switch(config-if)# switchport trunk allowed vlan add 20
Switch(config-if)# no shutdown
Switch(config-if)# exit
```

Interface configuration for Switch1:

```
Switch(config)# interface eth-0-9
Switch(config-if)# no switchport
Switch(config-if)# ip address 9.9.9.1/24
Switch(config-if)# overlay uplink enable
Switch(config-if)# no shutdown
Switch(config-if)# exit

Switch(config)# interface loopback0
Switch(config-if)# ip address 1.1.1.1/32
Switch(config-if)# exit
```

Interface configuration for Switch2:

```
Switch(config)# interface eth-0-9
Switch(config-if)# no switchport
Switch(config-if)# ip address 9.9.9.2/24
Switch(config-if)# overlay uplink enable
Switch(config-if)# no shutdown
Switch(config-if)# exit

Switch(config)# interface loopback0
Switch(config-if)# ip address 2.2.2.2/32
Switch(config-if)# exit
```

Step 4 Create a static route

Configuring Switch1:

```
Switch(config)# ip route 2.2.2.0/24 9.9.9.2
```

Configuring Switch2:

```
Switch(config)# ip route 1.1.1.0/24 9.9.9.1
```

step 5 Set attributes for overlay**Configuring Switch1:**

```
Switch(config)# overlay
Switch(config-overlay)# source 1.1.1.1
Switch(config-overlay)# remote-vtep 1 ip-address 2.2.2.2 type nvgre
Switch(config-overlay)# vlan 20 vni 20000
Switch(config-overlay)# vlan 20 remote-vtep 1
Switch(config-overlay)# exit
```

Configuring Switch2:

```
Switch(config)# overlay
Switch(config-overlay)# source 2.2.2.2
Switch(config-overlay)# remote-vtep 1 ip-address 1.1.1.1 type nvgre
Switch(config-overlay)# vlan 20 vni 20000
Switch(config-overlay)# vlan 20 remote-vtep 1
Switch(config-overlay)# exit
```

step 6 Exit the configure mode

```
Switch(config)# end
```

step 7 Validation**Display the result on Switch1:**

```
Switch# show overlay vlan 20
-----
ECMP Mode           : Normal
Source VTEP         : 1.1.1.1
-----
VLAN ID              : 20
VNI                  : 20000
EVPN Tunnel Data-fdb Learning : Eanble
Remote VTEP NUM: 1
                    Index: 1, Ip address: 2.2.2.2, Source ip: 1.1.1.1, Type: NvGRE, Protocol:
Static
DVR Gateway NUM: 0
-----
```

Display the result on Switch2:

```
Switch# show overlay vlan 20
-----
ECMP Mode           : Normal
Source VTEP         : 2.2.2.2
-----
```

```

.....
VLAN ID                : 20
VNI                    : 20000
EVPN Tunnel Data-fdb Learning : Eanble
Remote VTEP NUM: 1
                    Index: 1, Ip address: 1.1.1.1, Source ip: 2.2.2.2, Type: NvGRE, Protocol:
Static
DVR Gateway NUM: 0
.....

```

Configuring NVGRE Routing

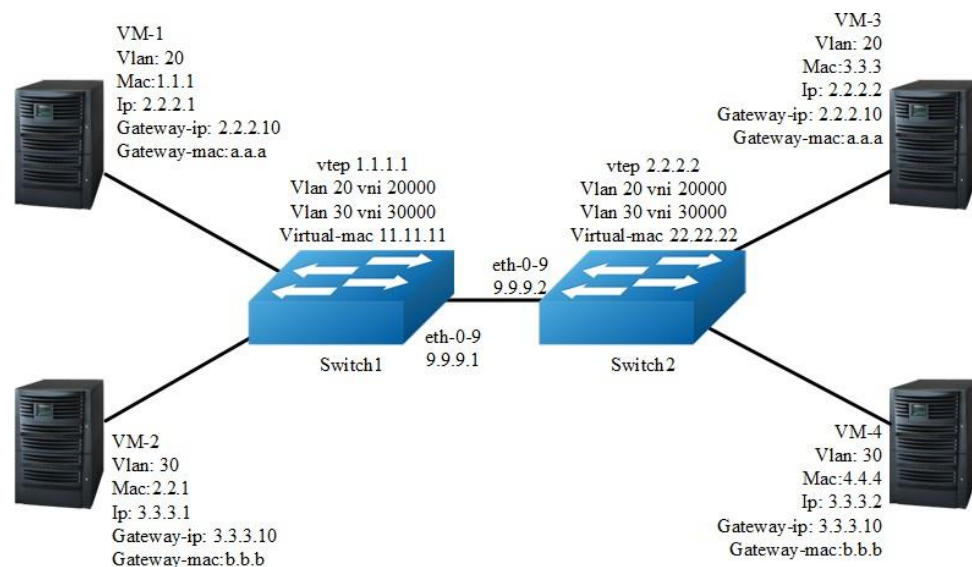

Figure 17-6 NVGRE

In the following example, VM-1 & VM-3 are encapsulated in same vni to make up the distributed route via NVGRE; VM-2 & VM-4 are encapsulated in another vni to make up the distributed route via NVGRE.

The following configuration should be operated on all switches if the switch ID is not specified.

step 1 Enter the configure mode

```
Switch# configure terminal
```

step 2 Enter the vlan configure mode and create vlan, enable overlay for each vlan

```
Switch(config)# vlan database
Switch(config-vlan)# vlan 20,30
```

```
Switch(config-vlan)# vlan 20 overlay enable
Switch(config-vlan)# vlan 30 overlay enable
Switch(config-vlan)# exit
```

step 3 Create a vrf instance

```
Switch(config)# ip vrf tenant
Switch(config-vrf)# exit
```

step 4 Create the layer 3 interface and set the ip address

Configuring Switch1:

```
Switch(config)# interface vlan 20
Switch(config-if)# ip vrf forwarding tenant
Switch(config-if)# ip address 2.2.2.111/24
Switch(config-if)# exit

Switch(config)# interface vlan 30
Switch(config-if)# ip vrf forwarding tenant
Switch(config-if)# ip address 3.3.3.111/24
Switch(config-if)# exit
```

Configuring Switch2:

```
Switch(config)# interface vlan 20
Switch(config-if)# ip vrf forwarding tenant
Switch(config-if)# ip address 2.2.2.222/24
Switch(config-if)# exit

Switch(config)# interface vlan 30
Switch(config-if)# ip vrf forwarding tenant
Switch(config-if)# ip address 3.3.3.222/24
Switch(config-if)# exit
```

step 5 Enter the interface configure mode and set the attributes of the interface

```
Switch(config)# interface eth-0-1
Switch(config-if)# switchport mode trunk
Switch(config-if)# switchport trunk allowed vlan add 20
Switch(config-if)# no shutdown
Switch(config-if)# exit

Switch(config)# interface eth-0-2
Switch(config-if)# switchport mode trunk
Switch(config-if)# switchport trunk allowed vlan add 30
Switch(config-if)# no shutdown
Switch(config-if)# exit
```

Configuring Switch1:

```
Switch(config)# interface eth-0-9
Switch(config-if)# no switchport
```



```
Switch(config-if)# ip address 9.9.9.1/24
Switch(config-if)# overlay uplink enable
Switch(config-if)# no shutdown
Switch(config-if)# exit

Switch(config)# interface loopback0
Switch(config-if)# ip address 1.1.1.1/32
Switch(config-if)# exit
```

Configuring Switch2:

```
Switch(config)# interface eth-0-9
Switch(config-if)# no switchport
Switch(config-if)# ip address 9.9.9.2/24
Switch(config-if)# overlay uplink enable
Switch(config-if)# no shutdown
Switch(config-if)# exit

Switch(config)# interface loopback0
Switch(config-if)# ip address 2.2.2.2/32
Switch(config-if)# exit
```

step 6 Set attributes for overlay

Configuring Switch1:

```
Switch(config)# overlay
Switch(config-overlay)# source 1.1.1.1
Switch(config-overlay)# remote-vtep 1 ip-address 2.2.2.2 type nvgre
Switch(config-overlay)# remote-vtep 1 virtual-mac 22.22.22
Switch(config-overlay)# vlan 20 vni 20000
Switch(config-overlay)# vlan 30 vni 30000
Switch(config-overlay)# vlan 20 remote-vtep 1
Switch(config-overlay)# vlan 30 remote-vtep 1
Switch(config-overlay)# vlan 20 gateway-mac a.a.a
Switch(config-overlay)# vlan 30 gateway-mac b.b.b
Switch(config-overlay)# exit
```

Configuring Switch2:

```
Switch(config)# overlay
Switch(config-overlay)# source 2.2.2.2
Switch(config-overlay)# remote-vtep 1 ip-address 1.1.1.1 type nvgre
Switch(config-overlay)# remote-vtep 1 virtual-mac 11.11.11
Switch(config-overlay)# vlan 20 vni 20000
Switch(config-overlay)# vlan 30 vni 30000
Switch(config-overlay)# vlan 20 remote-vtep 1
Switch(config-overlay)# vlan 30 remote-vtep 1
Switch(config-overlay)# vlan 20 gateway-mac a.a.a
Switch(config-overlay)# vlan 30 gateway-mac b.b.b
Switch(config-overlay)# exit
```

step 7 Create a static routes and NVGRE routes

Configuring Switch1:

```
Switch(config)# ip route 2.2.2.0/24 9.9.9.2
Switch(config)# ip route vrf tenant 2.2.2.2/32 remote-vtep 1 vni 20000 inner-macda
3.3.3
Switch(config)# ip route vrf tenant 3.3.3.2/32 remote-vtep 1 vni 30000 inner-macda
4.4.4
```

Configuring Switch2:

```
Switch(config)# ip route 1.1.1.0/24 9.9.9.1
Switch(config)# ip route vrf tenant 2.2.2.1/32 remote-vtep 1 vni 20000 inner-macda
1.1.1
Switch(config)# ip route vrf tenant 3.3.3.1/32 remote-vtep 1 vni 30000 inner-macda
2.2.2
```

step 8 Exit the configure mode

```
Switch(config)# end
```

step 9 Validation

Display the result on Switch1:

```
Switch# show ip route vrf tenant
Codes: K - kernel, C - connected, S - static, R - RIP, B - BGP
       O - OSPF, IA - OSPF inter area
       N1 - OSPF NSSA external type 1, N2 - OSPF NSSA external type 2
       E1 - OSPF external type 1, E2 - OSPF external type 2
       i - IS-IS, L1 - IS-IS level-1, L2 - IS-IS level-2, ia - IS-IS inter area
       Dc - DHCP Client
       [*] - [AD/Metric]
       * - candidate default
S       2.2.2.2/32 is in overlay remote nvgre vtep:1.1.1.1->2.2.2.2, vni:20000
S       3.3.3.2/32 is in overlay remote nvgre vtep:1.1.1.1->2.2.2.2, vni:30000
```

Display the result on Switch2:

```
Switch# show ip route vrf tenant
Codes: K - kernel, C - connected, S - static, R - RIP, B - BGP
       O - OSPF, IA - OSPF inter area
       N1 - OSPF NSSA external type 1, N2 - OSPF NSSA external type 2
       E1 - OSPF external type 1, E2 - OSPF external type 2
       i - IS-IS, L1 - IS-IS level-1, L2 - IS-IS level-2, ia - IS-IS inter area
       Dc - DHCP Client
       [*] - [AD/Metric]
       * - candidate default
S       2.2.2.1/32 is in overlay remote nvgre vtep:2.2.2.2->1.1.1.1, vni:20000
S       3.3.3.1/32 is in overlay remote nvgre vtep:2.2.2.2->1.1.1.1, vni:30000
```

17.2.3 Application cases

N/A

17.3 Configuring GENEVE

17.3.1 Overview

Function Introduction

Generic Network Virtualization Encapsulation (GENEVE) is a networking technology that encapsulates MAC-based Layer 2 Ethernet frames within Layer 3 UDP packets to aggregate and tunnel multiple layer 2 networks across a Layer 3 infrastructure. GENEVE scales up to 16 million logical networks and supports layer 2 adjacency across IP networks. Multicast transmission architecture is used for broadcast/multicast/unknown packets.

Principle Description

N/A

17.3.2 Configuration

GENEVE Configuration

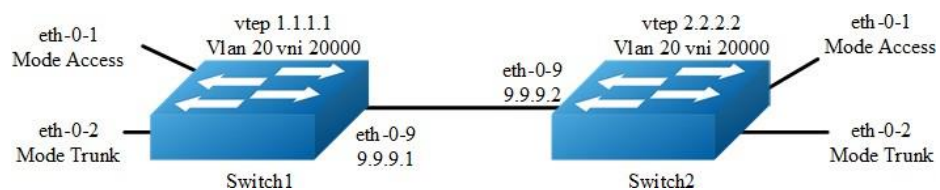

Figure 17-7 GENEVE

In the following example, switch1 and switch2 are connected via layer 3 route. The traffic of vlan 20 are encapsulated in vni 20000, in order to pass through the layer 3 networks.

The following configuration should be operated on all switches if the switch ID is not specified.

step 1 Enter the configure mode

```
Switch# configure terminal
```

step 2 Enter the vlan configure mode and create vlan, enable overlay for each vlan

```
Switch(config)# vlan database
Switch(config-vlan)# vlan 20
Switch(config-vlan)# vlan 20 overlay enable
Switch(config-vlan)# exit
```

step 3 Enter the interface configure mode and set the attributes of the interface

```
Switch(config)# interface eth-0-1
Switch(config-if)# switchport access vlan 20
Switch(config-if)# no shutdown
Switch(config-if)# exit

Switch(config)# interface eth-0-2
Switch(config-if)# switchport mode trunk
Switch(config-if)# switchport trunk allowed vlan add 20
Switch(config-if)# no shutdown
Switch(config-if)# exit
```

Interface configuration for Switch1:

```
Switch(config)# interface eth-0-9
Switch(config-if)# no switchport
Switch(config-if)# ip address 9.9.9.1/24
Switch(config-if)# overlay uplink enable
Switch(config-if)# no shutdown
Switch(config-if)# exit

Switch(config)# interface loopback0
Switch(config-if)# ip address 1.1.1.1/32
Switch(config-if)# exit
```

Interface configuration for Switch2:

```
Switch(config)# interface eth-0-9
Switch(config-if)# no switchport
Switch(config-if)# ip address 9.9.9.2/24
Switch(config-if)# overlay uplink enable
Switch(config-if)# no shutdown
Switch(config-if)# exit

Switch(config)# interface loopback0
Switch(config-if)# ip address 2.2.2.2/32
Switch(config-if)# exit
```

Step 4 Create a static route

Configuring Switch1:

```
Switch(config)# ip route 2.2.2.0/24 9.9.9.2
```

Configuring Switch2:

```
Switch(config)# ip route 1.1.1.0/24 9.9.9.1
```

step 5 Set attributes for overlay

Configuring Switch1:

```
Switch(config)# overlay
Switch(config-overlay)# source 1.1.1.1
Switch(config-overlay)# remote-vtep 1 ip-address 2.2.2.2 type geneve
Switch(config-overlay)# vlan 20 vni 20000
Switch(config-overlay)# vlan 20 remote-vtep 1
Switch(config-overlay)# exit
```

Configuring Switch2:

```
Switch(config)# overlay
Switch(config-overlay)# source 2.2.2.2
Switch(config-overlay)# remote-vtep 1 ip-address 1.1.1.1 type geneve
Switch(config-overlay)# vlan 20 vni 20000
Switch(config-overlay)# vlan 20 remote-vtep 1
Switch(config-overlay)# exit
```

step 6 Exit the configure mode

```
Switch(config)# end
```

step 7 Validation

Display the result on Switch1:

```
Switch# show overlay vlan 20
-----
ECMP Mode           : Normal
Source VTEP         : 1.1.1.1
-----
VLAN ID              : 20
VNI                  : 20000
EVPN Tunnel Data-fdb Learning : Eanble
Remote VTEP NUM: 1
      Index: 1, Ip address: 2.2.2.2, Source ip: 1.1.1.1, Type: GENEVE,
Protocol: Static
DVR Gateway NUM: 0
-----
```

Display the result on Switch2:

```
Switch# show overlay vlan 20
-----
ECMP Mode           : Normal
Source VTEP         : 2.2.2.2
-----
VLAN ID             : 20
VNI                  : 20000
EVPN Tunnel Data-fdb Learning : Enable
Remote VTEP NUM: 1
                    Index: 1, Ip address: 1.1.1.1, Source ip: 2.2.2.2, Type: GENEVE,
Protocol: Static
DVR Gateway NUM: 0
-----
```

Configuring GENEVE Routing

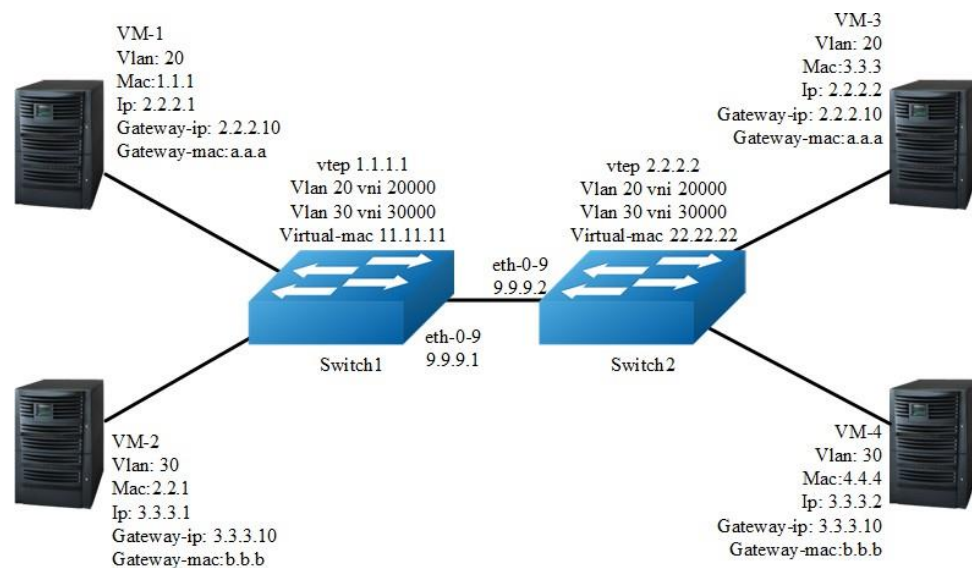

Figure 17-8 GENEVE

In the following example, VM-1 & VM-3 are encapsulated in same vni to make up the distributed route via GENEVE; VM-2 & VM-4 are encapsulated in another vni to make up the distributed route via GENEVE.

The following configuration should be operated on all switches if the switch ID is not specified.

step 1 Enter the configure mode

```
Switch# configure terminal
```

step 2 Enter the vlan configure mode and create vlan, enable overlay for each vlan

```
Switch(config)# vlan database
Switch(config-vlan)# vlan 20,30
Switch(config-vlan)# vlan 20 overlay enable
Switch(config-vlan)# vlan 30 overlay enable
Switch(config-vlan)# exit
```

step 3 Create a vrf instance

```
Switch(config)# ip vrf tenant
Switch(config-vrf)# exit
```

step 4 Create the layer 3 interface and set the ip address

Configuring Switch1:

```
Switch(config)# interface vlan 20
Switch(config-if)# ip vrf forwarding tenant
Switch(config-if)# ip address 2.2.2.111/24
Switch(config-if)# exit

Switch(config)# interface vlan 30
Switch(config-if)# ip vrf forwarding tenant
Switch(config-if)# ip address 3.3.3.111/24
Switch(config-if)# exit
```

Configuring Switch2:

```
Switch(config)# interface vlan 20
Switch(config-if)# ip vrf forwarding tenant
Switch(config-if)# ip address 2.2.2.222/24
Switch(config-if)# exit

Switch(config)# interface vlan 30
Switch(config-if)# ip vrf forwarding tenant
Switch(config-if)# ip address 3.3.3.222/24
Switch(config-if)# exit
```

step 5 Enter the interface configure mode and set the attributes of the interface

```
Switch(config)# interface eth-0-1
Switch(config-if)# switchport mode trunk
Switch(config-if)# switchport trunk allowed vlan add 20
Switch(config-if)# no shutdown
Switch(config-if)# exit

Switch(config)# interface eth-0-2
Switch(config-if)# switchport mode trunk
Switch(config-if)# switchport trunk allowed vlan add 30
```

```
Switch(config-if) # no shutdown
Switch(config-if) # exit
```

Configuring Switch1:

```
Switch(config) # interface eth-0-9
Switch(config-if) # no switchport
Switch(config-if) # ip address 9.9.9.1/24
Switch(config-if) # overlay uplink enable
Switch(config-if) # no shutdown
Switch(config-if) # exit

Switch(config) # interface loopback0
Switch(config-if) # ip address 1.1.1.1/32
Switch(config-if) # exit
```

Configuring Switch2:

```
Switch(config) # interface eth-0-9
Switch(config-if) # no switchport
Switch(config-if) # ip address 9.9.9.2/24
Switch(config-if) # overlay uplink enable
Switch(config-if) # no shutdown
Switch(config-if) # exit

Switch(config) # interface loopback0
Switch(config-if) # ip address 2.2.2.2/32
Switch(config-if) # exit
```

step 6 Set attributes for overlay

Configuring Switch1:

```
Switch(config) # overlay
Switch(config-overlay) # source 1.1.1.1
Switch(config-overlay) # remote-vtep 1 ip-address 2.2.2.2 type geneve
Switch(config-overlay) # remote-vtep 1 virtual-mac 22.22.22
Switch(config-overlay) # vlan 20 vni 20000
Switch(config-overlay) # vlan 30 vni 30000
Switch(config-overlay) # vlan 20 remote-vtep 1
Switch(config-overlay) # vlan 30 remote-vtep 1
Switch(config-overlay) # vlan 20 gateway-mac a.a.a
Switch(config-overlay) # vlan 30 gateway-mac b.b.b
Switch(config-overlay) # exit
```

Configuring Switch2:

```
Switch(config) # overlay
Switch(config-overlay) # source 2.2.2.2
Switch(config-overlay) # remote-vtep 1 ip-address 1.1.1.1 type geneve
Switch(config-overlay) # remote-vtep 1 virtual-mac 11.11.11
Switch(config-overlay) # vlan 20 vni 20000
Switch(config-overlay) # vlan 30 vni 30000
Switch(config-overlay) # vlan 20 remote-vtep 1
Switch(config-overlay) # vlan 20 remote-vtep 1
```



```
Switch(config-overlay)# vlan 20 gateway-mac a.a.a
Switch(config-overlay)# vlan 30 gateway-mac b.b.b
Switch(config-overlay)# exit
```

step 7 Create a static routes and GENEVE routes

Configuring Switch1:

```
Switch(config)# ip route 2.2.2.0/24 9.9.9.2
Switch(config)# ip route vrf tenant 2.2.2.2/32 remote-vtep 1 vni 20000 inner-macda
3.3.3
Switch(config)# ip route vrf tenant 3.3.3.2/32 remote-vtep 1 vni 30000 inner-macda
4.4.4
```

Configuring Switch2:

```
Switch(config)# ip route 1.1.1.0/24 9.9.9.1
Switch(config)# ip route vrf tenant 2.2.2.1/32 remote-vtep 1 vni 20000 inner-macda
1.1.1
Switch(config)# ip route vrf tenant 3.3.3.1/32 remote-vtep 1 vni 30000
```

step 8 Exit the configure mode

```
Switch(config)# end
```

step 9 Validation

Display the result on Switch1:

```
switch# show ip route vrf tenant
Codes: K - kernel, C - connected, S - static, R - RIP, B - BGP
       O - OSPF, IA - OSPF inter area
       N1 - OSPF NSSA external type 1, N2 - OSPF NSSA external type 2
       E1 - OSPF external type 1, E2 - OSPF external type 2
       i - IS-IS, L1 - IS-IS level-1, L2 - IS-IS level-2, ia - IS-IS inter area
       Dc - DHCP Client
       [*] - [AD/Metric]
       * - candidate default
S       2.2.2.2/32 is in overlay remote geneve vtep:1.1.1.1->2.2.2.2, vni:20000
S       3.3.3.2/32 is in overlay remote geneve vtep:1.1.1.1->2.2.2.2, vni:30000
```

Display the result on Switch2:

```
switch# show ip route vrf tenant
Codes: K - kernel, C - connected, S - static, R - RIP, B - BGP
       O - OSPF, IA - OSPF inter area
       N1 - OSPF NSSA external type 1, N2 - OSPF NSSA external type 2
       E1 - OSPF external type 1, E2 - OSPF external type 2
       i - IS-IS, L1 - IS-IS level-1, L2 - IS-IS level-2, ia - IS-IS inter area
       Dc - DHCP Client
       [*] - [AD/Metric]
       * - candidate default
```

```
S 2.2.2.1/32 is in overlay remote geneve vtep:2.2.2.2->1.1.1.1, vni:20000
S 3.3.3.1/32 is in overlay remote geneve vtep:2.2.2.2->1.1.1.1, vni:30000
```

17.3.3 Application cases

N/A

17.4 Configuring Overlay

17.4.1 Overview

Function Introduction

Overlay function supports multiple source ip address of vtep, it can set different source ip for different networks and improve the reliability of overlay.

Overlay function also supports tunnel without horizon split, it means that when uplink port receiving tunnel packets and decapsulate them , and then send them into another tunnel for encapsulation.

Principle Description

N/A

17.4.2 Configuration

Configuring Overlay multiple source ip

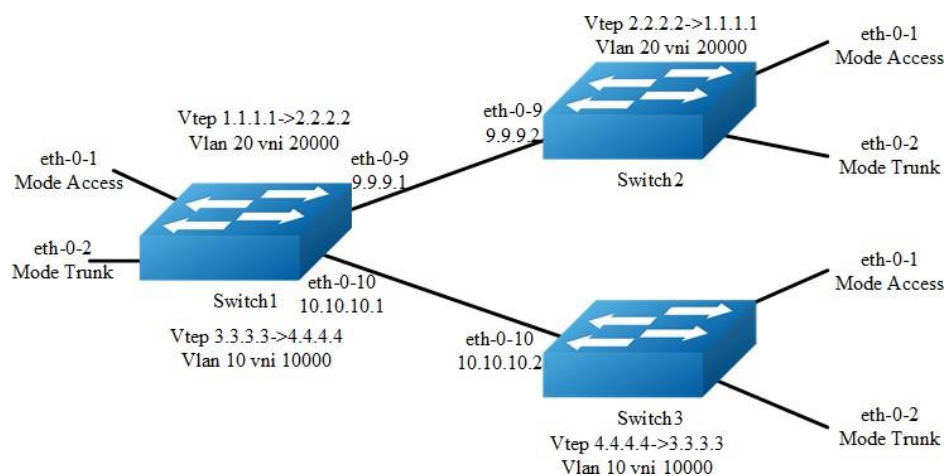

Figure 17-9 Overlay multiple source ip

The following example uses vxlan for overlay configuration. NVGRE and GENEVE configurations are similar with vxlan.

The following configuration should be operated on all switches if the switch ID is not specified.

step 1 Enter the configure mode

```
Switch# configure terminal
```

step 2 Enter the vlan configure mode and create vlan, enable overlay for each vlan**Configuring Switch1:**

```
Switch(config)# vlan database
Switch(config-vlan)# vlan 20,10
Switch(config-vlan)# vlan 20 overlay enable
Switch(config-vlan)# vlan 10 overlay enable
Switch(config-vlan)# exit
```

Configuring Switch2:

```
Switch(config)# vlan database
Switch(config-vlan)# vlan 20
Switch(config-vlan)# vlan 20 overlay enable
Switch(config-vlan)# exit
```

Configuring Switch3:

```
Switch(config)# vlan database
Switch(config-vlan)# vlan 10
Switch(config-vlan)# vlan 10 overlay enable
Switch(config-vlan)# exit
```

step 3 Enter the interface configure mode and set the attributes of the interface**Interface configuration for Switch1:**

```
Switch(config)# interface eth-0-1
Switch(config-if)# switchport access vlan 20
Switch(config-if)# no shutdown
Switch(config-if)# exit

Switch(config)# interface eth-0-2
Switch(config-if)# switchport mode trunk
Switch(config-if)# switchport trunk allowed vlan add 10
Switch(config-if)# no shutdown
Switch(config-if)# exit
```

```
Switch(config)# interface eth-0-9
Switch(config-if)# no switchport
Switch(config-if)# ip address 9.9.9.1/24
Switch(config-if)# overlay uplink enable
Switch(config-if)# no shutdown
Switch(config-if)# exit

Switch(config)# interface eth-0-10
Switch(config-if)# no switchport
Switch(config-if)# ip address 10.10.10.1/24
Switch(config-if)# overlay uplink enable
Switch(config-if)# no shutdown
Switch(config-if)# exit

Switch(config)# interface loopback0
Switch(config-if)# ip address 1.1.1.1/32
Switch(config)# interface loopback1
Switch(config-if)# ip address 3.3.3.3/32
Switch(config-if)# exit
```

Interface configuration for Switch2:

```
Switch(config)# interface eth-0-1
Switch(config-if)# switchport access vlan 20
Switch(config-if)# no shutdown
Switch(config-if)# exit

Switch(config)# interface eth-0-2
Switch(config-if)# switchport mode trunk
Switch(config-if)# switchport trunk allowed vlan add 20
Switch(config-if)# no shutdown
Switch(config-if)# exit

Switch(config)# interface eth-0-9
Switch(config-if)# no switchport
Switch(config-if)# ip address 9.9.9.2/24
Switch(config-if)# overlay uplink enable
Switch(config-if)# no shutdown
Switch(config-if)# exit

Switch(config)# interface loopback0
Switch(config-if)# ip address 2.2.2.2/32
Switch(config-if)# exit
```

Interface configuration for Switch3:

```
Switch(config)# interface eth-0-1
Switch(config-if)# switchport access vlan 10
Switch(config-if)# no shutdown
Switch(config-if)# exit

Switch(config)# interface eth-0-2
Switch(config-if)# switchport mode trunk
Switch(config-if)# switchport trunk allowed vlan add 10
Switch(config-if)# no shutdown
```

```
Switch(config-if)# exit

Switch(config)# interface eth-0-10
Switch(config-if)# no switchport
Switch(config-if)# ip address 10.10.10.2/24
Switch(config-if)# overlay uplink enable
Switch(config-if)# no shutdown
Switch(config-if)# exit

Switch(config)# interface loopback0
Switch(config-if)# ip address 4.4.4.4/32
Switch(config-if)# exit
```

step 4 Create static routes

Configuring Switch1:

```
Switch(config)# ip route 2.2.2.0/24 9.9.9.2
Switch(config)# ip route 4.4.4.0/24 10.10.10.2
```

Configuring Switch2:

```
Switch(config)# ip route 1.1.1.0/24 9.9.9.1
```

Configuring Switch3:

```
Switch(config)# ip route 3.3.3.0/24 10.10.10.1
```

step 5 Set attributes for overlay

Configuring Switch1:

```
Switch(config)# overlay
Switch(config-overlay)# source 1.1.1.1
Switch(config-overlay)# remote-vtep 1 ip-address 2.2.2.2 type vxlan
Switch(config-overlay)# remote-vtep 2 ip-address 4.4.4.4 type vxlan src-ip 3.3.3.3
Switch(config-overlay)# vlan 20 vni 20000
Switch(config-overlay)# vlan 10 vni 10000
Switch(config-overlay)# vlan 20 remote-vtep 1
Switch(config-overlay)# vlan 10 remote-vtep 2
Switch(config-overlay)# exit
```

Configuring Switch2:

```
Switch(config)# overlay
Switch(config-overlay)# source 2.2.2.2
Switch(config-overlay)# remote-vtep 1 ip-address 1.1.1.1 type vxlan
Switch(config-overlay)# vlan 20 vni 20000
Switch(config-overlay)# vlan 20 remote-vtep 1
Switch(config-overlay)# exit
```

Configuring Switch3:

```
Switch(config)# overlay
Switch(config-overlay)# source 4.4.4.4
Switch(config-overlay)# remote-vtep 1 ip-address 3.3.3.3 type vxlan
Switch(config-overlay)# vlan 10 vni 10000
Switch(config-overlay)# vlan 10 remote-vtep 1
Switch(config-overlay)# exit
```

step 6 Exit the configure mode

```
Switch(config)# end
```

step 7 Validation

Display the result on Switch1:

```
switch# show overlay vlan 20
-----
ECMP Mode           : Normal
Source VTEP         : 1.1.1.1
-----
VLAN ID              : 2
VNI                  : 20000
EVPN Tunnel Data-fdb Learning : Eanble
Remote VTEP NUM: 1
      Index: 1, Ip address: 2.2.2.2, Source ip: 1.1.1.1, Type: VxLAN, Protocol:
Static
      Index: 2, Ip address: 2.2.2.2, Source ip: 3.3.3.3, Type: VxLAN, Protocol:
Static
DVR Gateway NUM: 0
-----
```

Configuring OVERLAY without Horizon Split

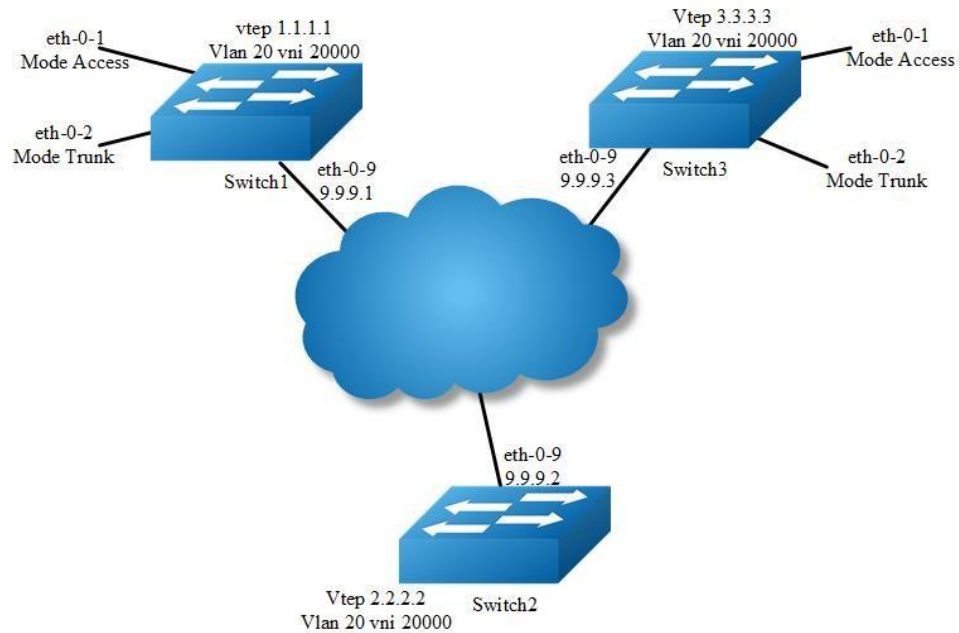

Figure 17-10 OVERLAY without Horizon Split

In the following example, there is a tunnel between switch1 and switch2, there is another tunnel between switch2 and switch3. The horizon split is disabled on switch2, therefore packets from one tunnel can be forwarded to another tunnel.

The following example uses vxlan for overlay configuration. NVGRE and GENEVE configurations are similar with vxlan.

The following configuration should be operated on all switches if the switch ID is not specified.

step 1 Enter the configure mode

```
Switch# configure terminal
```

step 2 Enter the vlan configure mode and create vlan, enable overlay for each vlan

```
Switch(config)# vlan database
Switch(config-vlan)# vlan 20
Switch(config-vlan)# vlan 20 overlay enable
Switch(config-vlan)# exit
```

step 3 Enter the interface configure mode and set the attributes of the interface

Interface configuration for Switch1:

```
Switch(config)# interface eth-0-1
Switch(config-if)# switchport access vlan 20
Switch(config-if)# no shutdown
Switch(config-if)# exit

Switch(config)# interface eth-0-2
Switch(config-if)# switchport mode trunk
Switch(config-if)# switchport trunk allowed vlan add 20
Switch(config-if)# no shutdown
Switch(config-if)# exit

Switch(config)# interface eth-0-9
Switch(config-if)# no switchport
Switch(config-if)# ip address 9.9.9.1/24
Switch(config-if)# overlay uplink enable
Switch(config-if)# no shutdown
Switch(config-if)# exit

Switch(config)# interface loopback0
Switch(config-if)# ip address 1.1.1.1/32
Switch(config-if)# exit
```

Interface configuration for Switch2:

```
Switch(config-if)# interface eth-0-9
Switch(config-if)# no switchport
Switch(config-if)# ip address 9.9.9.2/24
Switch(config-if)# overlay uplink enable
Switch(config-if)# no shutdown
Switch(config-if)# exit

Switch(config)# interface loopback0
Switch(config-if)# ip address 2.2.2.2/32
Switch(config-if)# exit
```

Interface configuration for Switch3:

```
Switch(config)# interface eth-0-1
Switch(config-if)# switchport access vlan 20
Switch(config-if)# no shutdown
Switch(config-if)# exit

Switch(config)# interface eth-0-2
Switch(config-if)# switchport mode trunk
Switch(config-if)# switchport trunk allowed vlan add 20
Switch(config-if)# no shutdown
Switch(config-if)# exit

Switch(config)# interface eth-0-9
Switch(config-if)# no switchport
Switch(config-if)# ip address 9.9.9.3/24
```



```
Switch(config-if)# overlay uplink enable
Switch(config-if)# no shutdown
Switch(config-if)# exit

Switch(config)# interface loopback0
Switch(config-if)# ip address 3.3.3.3/32
Switch(config-if)# exit
```

step 4 Create a static route

Configuring Switch1:

```
Switch(config)# ip route 2.2.2.0/24 9.9.9.2
```

Configuring Switch2:

```
Switch(config)# ip route 1.1.1.0/24 9.9.9.1
Switch(config)# ip route 3.3.3.3/24 9.9.9.3
```

Configuring Switch3:

```
Switch(config)# ip route 2.2.2.0/24 9.9.9.2
```

step 5 Set attributes for overlay

Configuring Switch1:

```
Switch(config)# overlay
Switch(config-overlay)# source 1.1.1.1
Switch(config-overlay)# remote-vtep 1 ip-address 2.2.2.2 type vxlan
Switch(config-overlay)# vlan 20 vni 20000
Switch(config-overlay)# vlan 20 remote-vtep 1
Switch(config-overlay)# exit
```

Configuring Switch2:

```
Switch(config)# overlay
Switch(config-overlay)# source 2.2.2.2
Switch(config-overlay)# remote-vtep 1 ip-address 1.1.1.1 type vxlan horizon-split-
disable
Switch(config-overlay)# remote-vtep 2 ip-address 3.3.3.3 type vxlan horizon-split-
disable
Switch(config-overlay)# vlan 20 vni 20000
Switch(config-overlay)# vlan 20 remote-vtep 1
Switch(config-overlay)# vlan 20 remote-vtep 2
Switch(config-overlay)# exit
```

Configuring Switch3:

```
Switch(config)# overlay
Switch(config-overlay)# source 3.3.3.3
Switch(config-overlay)# remote-vtep 1 ip-address 2.2.2.2 type vxlan
Switch(config-overlay)# vlan 20 vni 20000
```

```
Switch(config-overlay) # vlan 20 remote-vtep 1
Switch(config-overlay) # exit
```

step 6 Exit the configure mode

```
Switch(config) # end
```

step 7 Validation

Display the result on Switch2:

```
switch# show overlay remote-vtep
Index Type      Virtual-Mac      IP-Address      Source-Ip      Split-Horizon      Keep-vtag      Dscp-
strategy
-----
1      VxLAN          -                1.1.1.1         2.2.2.2        Disable            Disable
Dscp-copy
2      VxLAN          -                3.3.3.3         2.2.2.2        Disable            Disable
Dscp-copy
```

17.4.3 Application cases

N/A

17.5 Configuring OVSDB

17.5.1 Overview

Function Introduction

OVSDB (Open vSwitch Database) is the database for saving configuration on switch. The OVSDB system comprises OVSDB server and OVSDB client. Controller, working as OVSDB client, will configure and query to the OVSDB on switch by OVSDB management protocol. Then all hardware VTEP in the network will be configured and deployed.

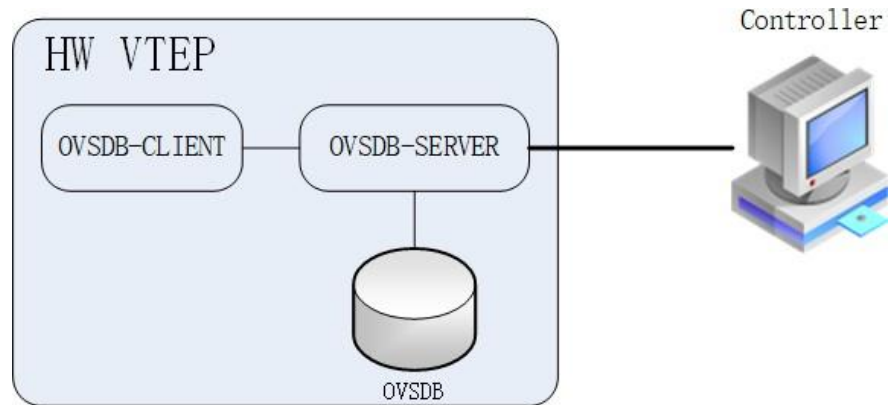

Figure 17-11 OVSDb

After OVSDb function enabled, the switch configured as hardware VTEP, will create and manage OVSDb database. Controller will connect to the OVSDb server on the switch and operate the data in the OVSDb. Then the data in the OVSDb will be translate to VXLAN configuration by the switch.

The supported OVSDb schema tables is list as follows:

Table Name	Description	Source of Information	Command	Comment
Global table	Top-level configuration for a hardware VTEP, include physical switch managed by OVSDb	Switch		
Manager table	Configuration for all connection from controller to OVSDb server	Switch or Controller	ovsdb controller	

Physical switch table	Information of physical switch that implements a VTEP	Switch		
Physical port table	Information about OVSDB-managed interfaces	Switch	ovsdb port enable	
Logical switch table	Include information about logical switch, which VXLAN tunnel will be configured according to	Controller		
Physical locator table	Include information about switch configured as hardware VTEP.	Controller		
Physical locator set table	Lists service nodes for a logical switch	Controller		
Unicast MACs remote table	Including unicast MAC entities in the virtual network.	Controller		Only support "Unknown-dst" entry

Multicast MACs remote table	Including multicast MAC entities to tunnels (physical locators) in the virtual network.	Controller		
-----------------------------	---	------------	--	--

Principle Description

N/A

17.5.2 Configuration

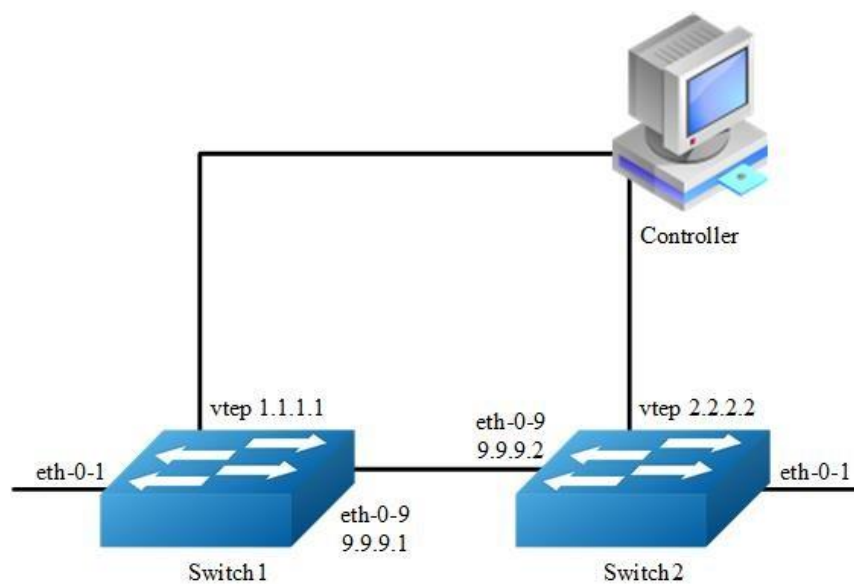

Figure 17-12 OVSDB

The following configuration should be operated on all switches if the switch ID is not specified.

step 1 Enter the configure mode

```
Switch# configure terminal
```

step 2 Enter the interface configure mode and set the attributes of the interface

Interface configuration for Switch1:

```
Switch(config)# interface eth-0-1
Switch(config-if)# ovbdb port enable
Switch(config-if)# no shutdown
Switch(config-if)# exit

Switch(config)# interface eth-0-9
Switch(config-if)# no switchport
Switch(config-if)# ip address 9.9.9.1/24
Switch(config-if)# overlay uplink enable
Switch(config-if)# no shutdown
Switch(config-if)# exit

Switch(config)# interface loopback0
Switch(config-if)# ip address 1.1.1.1/32
Switch(config-if)# exit
```

Interface configuration for Switch2:

```
Switch(config)# interface eth-0-1
Switch(config-if)# ovbdb port enable
Switch(config-if)# no shutdown
Switch(config-if)# exit

Switch(config)# interface eth-0-9
Switch(config-if)# no switchport
Switch(config-if)# ip address 9.9.9.2/24
Switch(config-if)# overlay uplink enable
Switch(config-if)# no shutdown
Switch(config-if)# exit

Switch(config)# interface loopback0
Switch(config-if)# ip address 2.2.2.2/32
Switch(config-if)# exit
```

step 3 Create static routes

Configuring Switch1:

```
Switch(config)# ip route 2.2.2.0/24 9.9.9.2
```

Configuring Switch2:

```
Switch(config)# ip route 1.1.1.0/24 9.9.9.1
```

step 4 Set attributes for overlay

Configuring Switch1:

```
Switch(config)# overlay
Switch(config-overlay)# source 1.1.1.1
Switch(config-overlay)# exit
```

Configuring Switch2:

```
Switch(config)# overlay
Switch(config-overlay)# source 2.2.2.2
Switch(config-overlay)# exit
```

step 5 Enable ovsdb globally

```
Switch(config)# ovsdb enable
```

step 6 Exit the configure mode

```
Switch(config)# end
```

step 7 Validation

Display the result on Switch1:

```
Switch# show running
overlay
 source 1.1.1.1
!

interface eth-0-1
 ovsdb port enable

interface eth-0-9
 no switchport
 overlay uplink enable
 ip address 9.9.9.1/24

interface loopback0
 ip address 1.1.1.1/32
!
ovsdb enable

Switch# show ovsdb physical-switch
Physical Switch Name : switch
Management IP address :
Tunnel IP address : 1.1.1.1
```

17.5.3 Application cases

N/A

18 Intelligent Lossless Network Configuration Guide

18.1 Configuring Priority-based Flow Control

18.1.1 Overview

Function Introduction

In a network path that normally consists of multiple hops between source and destination, lack of feedback between transmitters and receivers at each hop is one of the main causes of unreliability. Transmitters can send packets faster than receivers accept packets, and as the receivers run out of available buffer space to absorb incoming flows, they are forced to silently drop all traffic that exceeds their capacity. These semantics work fine at Layer 2, so long as upper-layer protocols handle drop-detection and retransmission logic.

For applications that cannot build reliability on upper layers, the addition of flow control functions at Layer 2 can offer a solution. Flow control enables feedback from a receiver to its sender to communicate buffer availability. Its first implementation in IEEE 802.3 Ethernet uses the IEEE 802.3x PAUSE control frames. IEEE 802.3x PAUSE is defined in Annex 31B of the IEEE 802.3 specification. Simply put, a receiver can generate a MAC control frame and send a PAUSE request to a sender when it predicts the potential for buffer overflow. Upon receiving a PAUSE frame, the sender responds by stopping transmission of any new packets until the receiver is ready to accept them again.

IEEE 802.3x PAUSE works as designed, but it suffers a basic disadvantage that limits its field of applicability: after a link is paused, a sender cannot generate any more packets. As obvious as that seems, the consequence is that the application of IEEE 802.3x PAUSE makes an Ethernet segment unsuitable for carrying multiple traffic flows that might require different quality of service (QoS). Thus, enabling IEEE 802.3x PAUSE for one application can affect the performance of other network applications.

IEEE 802.1Qbb PFC extends the basic IEEE 802.3x PAUSE semantics to multiple CoSs, enabling applications that require flow control to coexist on the same wire with applications that perform better without it. PFC uses the IEEE 802.1p CoS values in the IEEE 802.1Q VLAN tag to differentiate up to eight CoSs that can be subject to flow control independently.

Principle Description

N/A

18.1.2 Configuration

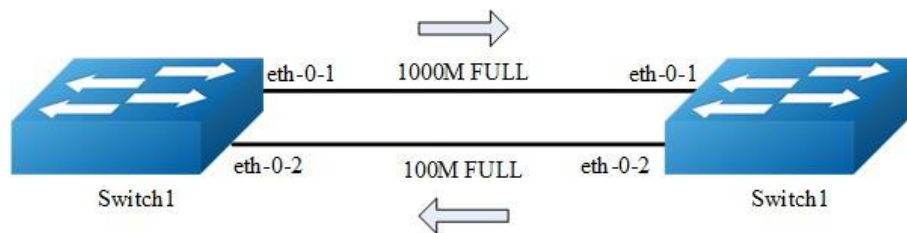

Figure 18-1 Priority-based Flow Control

In the following example, interface eth-0-1 of switch1 and switch2 are connected, interface eth-0-2 of switch1 and switch2 are connected, all interface enable PFC for priority 2/3/4.

The following configuration are same for switch1 and 2.

step 1 Enter the configure mode

```
Switch# configure terminal
```

step 2 Enable lldp globally

```
Switch1(config)# lldp enable
```

step 3 Enter the interface configure mode and set the attributes of the interface

```
Switch(config-if)#lldp enable txrx
Switch(config-if)# lldp tlv 8021-org-specific dcbx
Switch(config-if)# priority-flow-control mode on
Switch(config-if)# priority-flow-control enable priority 2 3 4
Switch(config-if)# exit

Switch(config)# interface eth-0-2
```

```
Switch(config-if)#lldp enable txrx
Switch(config-if)# lldp tlv 8021-org-specific dcbx
Switch(config-if)# priority-flow-control mode auto
Switch(config-if)# priority-flow-control enable priority 2 3 4
Switch (config-if)# exit
```

step 4 Exit the configure mode

```
Switch(config)# end
```

step 5 Validation

Display the result on Switch1:

```
switch# show priority-flow-control
```

Port	PFC-enable		PFC-enable on priority	
	admin	oper	admin	oper
eth-0-1	on	on	234	234
eth-0-2	auto	off	234	off
eth-0-3	off	off	off	off
eth-0-4	off	off	off	off
eth-0-5	off	off	off	off
eth-0-6	off	off	off	off
eth-0-7	off	off	off	off
eth-0-8	off	off	off	off
eth-0-9	off	off	off	off
eth-0-10	off	off	off	off
eth-0-11	off	off	off	off
eth-0-12	off	off	off	off
eth-0-13	off	off	off	off
eth-0-14	off	off	off	off
eth-0-15	off	off	off	off
eth-0-16	off	off	off	off
eth-0-17	off	off	off	off
eth-0-18	off	off	off	off
eth-0-19	off	off	off	off
eth-0-20	off	off	off	off
eth-0-21	off	off	off	off
eth-0-22	off	off	off	off
eth-0-23	off	off	off	off
eth-0-24	off	off	off	off

Display the result on Switch2:

```
switch# show priority-flow-control
```

Port	PFC-enable		PFC-enable on priority	
	admin	oper	admin	oper
eth-0-1	on	on	234	234
eth-0-2	auto	on	234	off
eth-0-3	off	off	off	off
eth-0-4	off	off	off	off
eth-0-5	off	off	off	off

eth-0-6	off	off	off	off
eth-0-7	off	off	off	off
eth-0-8	off	off	off	off
eth-0-9	off	off	off	off
eth-0-10	off	off	off	off
eth-0-11	off	off	off	off
eth-0-12	off	off	off	off
eth-0-13	off	off	off	off
eth-0-14	off	off	off	off
eth-0-15	off	off	off	off
eth-0-16	off	off	off	off
eth-0-17	off	off	off	off
eth-0-18	off	off	off	off
eth-0-19	off	off	off	off
eth-0-20	off	off	off	off
eth-0-21	off	off	off	off
eth-0-22	off	off	off	off
eth-0-23	off	off	off	off
eth-0-24	off	off	off	off

18.1.3 Application cases

N/A

18.2 Configuring EFD

18.2.1 Overview

Function Introduction

Elephant Flow Detect (EFD). According to the academic institutions of the actual network of the study found that more than 80% of the bandwidth is occupied by elephant flow, the bandwidth and transmission cache of these flow is large, but not sensitive to delay, which is sensitive to delay The flow caused a great impact. If elephant flow is recognized and some forwarding policies are implemented (such as reducing the forwarding priority of elephant flow appropriately, let mice flow be forwarded first), it can improve the transmission efficiency of network.

EFD function can be used to detect some abnormal traffic in the network (such as large bandwidth flow). After detecting, you can encapsulate the characteristics in the protocol packets and sent it to the specified server for further analysis.

Principle Description

terminology:

- EFD: Elephant Flow Detect

18.2.2 Configuration

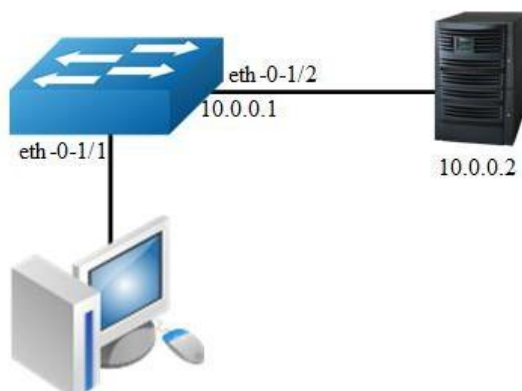

Figure 18-2 EFD

In the following example, it specifies the characteristics field and threshold of the traffic. When the flow rate exceed the specified threshold, the characteristics of the packets will be encapsulated into the user-defined UDP packets and sent to the server.

step 1 Enter the configure mode

```
Switch# configure terminal
```

step 1 Set the parameters for EFC

Specify ipda to calculate packet's hash value

```
Switch(config)# hash-value global
Switch(config-hash-value-global)# efd select ipda
```

Configure the speed threshold of EFD. The flows which has the rate large than 1000Mbps will be marked as Elephant Flow. The default value is 50Mbps.

```
Switch(config)# efd detect speed 1000
```

Enable EFD notify feature, and specify the ipda and UDP port of notification packet

```
Switch(config)# efd notify enable 10.0.0.2 20007
```

step 3 Enter the interface configure mode and set the attributes of the interface

```
Switch(config)# interface eth-0-1/1
Switch(config-if)# efd enable
Switch(config-if)# exit

Switch(config)# int eth-0-1/2
Switch(config-if)# no switchport
Switch(config-if)# ip address 10.0.0.1/24
Switch(config-if)# exit
```

step 4 Create a static arp entry (Optional)

```
Switch(config)# arp 10.0.0.2 0.1.2
```

step 5 Exit the configure mode

```
Switch(config)# end
```

step 6 Validation

```
Switch# show efd configuration
Elephant flow detection configuration information:
-----
Detect rate           : 1000 Mbps
Detect granularity    : 16B
Detect time interval  : 1000 ms
EFD aging time        : 120 ms ~ 150 ms
EFD detect packet type : All IP packets
EFD IPG               : disable
EFD redirect interface : N/A
EFD flow hash fields  : destination-ip
EFD enabled interface :
-----
eth-0-1/1
```

When the flow received from eth-0-1 exceed 1000Mb, we can find this flow has been learned as EFD flow via the CLI below:

```
Switch# show efd flow information decap
EFD flow issued at:07:29:40 UTC Mon Aug 01 2016
From:eth-0-1, FlowId: 1701
-----
MACDA:0000.00aa.bbbb, MACSA:0000.00bb.bbbb
IPv4 Packet, IP Protocol is TCP(6)
IPDA:22.22.22.101, IPSA: 11.11.11.11
L4SourcePort:43690, L4DestinationPort:43741
-----
00 00 00 aa bb bb 00 00 00 bb bb bb 08 00 45 00
00 32 00 00 40 00 c8 06 70 35 0b 0b 0b 0b 16 16
16 65 aa aa aa dd aa aa aa dd aa aa aa dd aa aa
aa dd aa aa aa dd aa aa aa dd aa aa aa dd aa aa
```

Server 10.0.0.2 Tcpdump result:

```

12:41:28.286993 92:fd:58:d7:8f:00 > 00:00:00:01:00:02, ethertype IPv4 (0x0800),
length 60: IP (tos 0x0, ttl 64, id 0, offset 0, flags [DF], proto 17, length: 44)
10.0.0.1.49071 > 10.0.0.2.20007: [udp sum ok] UDP, length 16
    0x0000:  0000 0001 0002 92fd 58d7 8f00 0800 4500  .....X.... E.
    0x0010:  002c 0000 4000 4011 26bf 0a00 0001 0a00  ..,..@. @. &.....
    0x0020:  0002 bfaf 4e27 0018 b05b 0000 0101 0000  ...N'...[.....
    0x0030:  0008 0001 0004 1616 1665 0000  ..... e..

```

**NOTE**

EFD packet head description. The red part above is part of EFD packet information, specific analysis is as follows:

- 0000: reserved, no specific meaning. Part of EFD packet head.
- 01:EFD packet version number, only support 0x01. Part of EFD packet head.
- 01:EFD flow opcode, 0x01: This flow is first recognized as elephant flow. 0x02: This flow has been recognized as elephant flow before. Part of EFD packet head.
- 0000 0008: EFD packet data part length(include data part type). Part of EFD packet head.
- 0001: EFD packet data part type. 0x0001 means data part is IPDA.
- 0004: EFD packet data part length.
- 16161665:date part, means IPDA is 22.22.22.101

18.2.3 Application cases

N/A

19 MPLS Configuration Guide

19.1 Configuring LDP

19.1.1 Overview

Function Introduction

This chapter describes how to configure LDP.

A fundamental concept in MPLS is that two Label Switching Routers (LSRs) must agree on the meaning of the labels used to forward traffic between and through them. This common understanding is achieved by using a set of procedures, called label distribution protocol -LDP. The OS software supports these features:

- Downstream unsolicited label distribution with liberal retention mode.
- Supports control-mode modification.
- Supports lsr-id and transport-address modification.
- Supports target peer setting.
- Supports outbound label filtering.
- Supports explicit null label.

This configuration guide will describe the basic configuration of LDP in our system and give some examples for it.

More information about LDP, please see RFC3031 and FRC3036.

Principle Description

N/A

19.1.2 Configuration

LDP Configuration

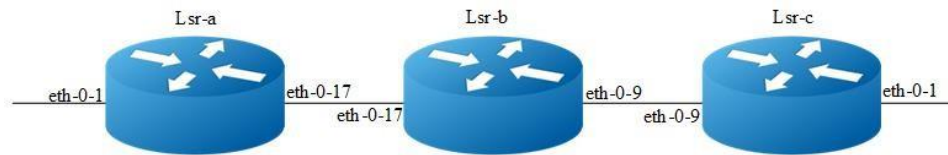

Figure 19-1 LSP map

The following example will describe how to use LDP to set up a label switching path (LSP) from lsr-a to lsr-c.

The following configuration should be operated on all switches if the switch ID is not specified.

step 1 Enter the configure mode

```
Switch# configure terminal
```

step 2 Enter the interface configure mode and set the attributes of the interface

Interface configuration for Lsr-a, interface need enable ldp and enable label switch:

```
Switch(config)# interface eth-0-17
Switch(config-if)# no switchport
Switch(config-if)# ip address 11.11.17.1/24
Switch(config-if)# enable-ldp
Switch(config-if)# label-switching
Switch(config-if)# exit
Switch(config)# interface loopback0
Switch(config-if)# ip address 1.1.1.1/32
Switch(config-if)# exit
```

Interface configuration for Lsr-b, interface need enable ldp and enable label switch:

```
Switch(config)# interface eth-0-17
Switch(config-if)# no switchport
Switch(config-if)# ip address 11.11.17.2/24
Switch(config-if)# enable-ldp
Switch(config-if)# label-switching
Switch(config-if)# exit
Switch(config)# interface eth-0-9
Switch(config-if)# no switchport
Switch(config-if)# ip address 11.11.9.1/24
Switch(config-if)# enable-ldp
Switch(config-if)# label-switching
```



```
Switch(config-if)# exit
Switch(config)# interface loopback0
Switch(config-if)# ip address 2.2.2.2/32
Switch(config-if)# exit
```

Interface configuration for Lsr-c, interface need enable ldp and enable label switch:

```
Switch(config)# interface eth-0-9
Switch(config-if)# no switchport
Switch(config-if)# ip address 11.11.9.2/24
Switch(config-if)# enable-ldp
Switch(config-if)# label-switching
Switch(config-if)# exit
Switch(config)# interface loopback0
Switch(config-if)# ip address 3.3.3.3/32
Switch(config-if)# exit
```

step 3 Enable router ldp

Configuration for Lsr-a:

```
Switch(config)# router ldp
Switch(config-router)# router-id 1.1.1.1
Switch(config-router)# exit
```

Configuration for Lsr-b:

```
Switch(config)# router ldp
Switch(config-router)# router-id 2.2.2.2
Switch(config-router)# exit
```

Configuration for Lsr-c:

```
Switch(config)# router ldp
Switch(config-router)# router-id 3.3.3.3
Switch(config-router)# exit
```

step 4 Enable router rip

```
Switch(config)# router rip
Switch(config-router)# network 0.0.0.0/0
Switch(config-router)# exit
```

step 5 Exit the configure mode

```
Switch(config)# end
```

step 6 Validation

Display the result of Lsr-a ldp session state:

```
Switch# show ldp session
Peer IP Address    IF Name    My Role    State        KeepAlive
2.2.2.2           eth-0-17   Passive    OPERATIONAL  30
```

Display the result of Lsr-b ldp session state:

```
Switch# show ldp session
Peer IP Address    IF Name    My Role    State        KeepAlive
3.3.3.3           eth-0-9    Active     OPERATIONAL  30
1.1.1.1           eth-0-17   Active     OPERATIONAL  30
```

Display the result of Lsr-c ldp session state:

```
Switch# show ldp session
Peer IP Address    IF Name    My Role    State        KeepAlive
2.2.2.2           eth-0-9    Passive    OPERATIONAL  30
```

19.2 Configuring MPLS

19.2.1 Overview

Function Introduction

MPLS stands for "Multiprotocol Label Switching", multiprotocol, because its techniques are applicable to ANY network layer protocol. In this document, however, we focus on the use of IP as the network layer protocol.

Packet headers contain considerably more information than is needed simply to choose the next hop. Choosing the next hop can therefore be thought of as the composition of two functions. The first function partitions the entire set of possible packets into a set of "Forwarding Equivalence Classes (FECs)". Secondly maps each FEC to a next hop. So far as the forwarding decision is concerned, different packets which get mapped into the same FEC are indistinguishable. All packets which belong to a particular FEC and which travel from a particular node will follow the same path (or if certain kinds of multi-path routing are in use, they will all follow one of a set of paths associated with the FEC). In conventional IP forwarding, a particular router will typically consider two packets to be in the same FEC if there is some address prefix X in that router's routing tables such that X is the "longest match" for each packet's destination address. As the packet traverses the network, each hop in turn reexamines the packet and assigns it to a FEC.

In MPLS, the assignment of a particular packet to a particular FEC is done just once, as the packet enters the network. The FEC to which the packet is assigned is encoded

as a short fixed length value known as a "label". When a packet is forwarded to its next hop, the label is sent along with it; that is, the packets are "labeled" before they are forwarded. At subsequent hops, there is no further analysis of the packet's network layer header. Rather, the label is used as an index into a table which specifies the next hop, and a new label. The old label is replaced with the new label, and the packet is forwarded to its next hop.

In the MPLS forwarding paradigm, once a packet is assigned to a FEC, no further header analysis is done by subsequent routers; all forwarding is driven by the labels.

Principle Description

N/A

19.2.2 Configuration

MPLS LSP Configuration

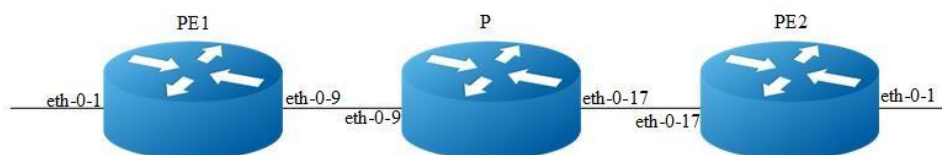

Figure 19-2 MPLS LSP model

The following example will describe how to configure MPLS LSP.

The following configuration should be operated on all switches if the switch ID is not specified.

step 1 Enter the configure mode

```
Switch# configure terminal
```

step 2 Enter the interface configure mode and set the attributes of the interface

Interface configuration for PE1, interface need enable label switch:

```
Switch(config)# interface eth-0-9
Switch(config-if)# no switchport
Switch(config-if)# ip address 11.11.9.1/24
Switch(config-if)# label-switching
Switch(config-if)# exit
```

```
Switch(config)# interface eth-0-1
Switch(config-if)# no switchport
Switch(config-if)# ip address 10.10.10.1/24
Switch(config-if)# label-switching
Switch(config-if)# exit
```

Interface configuration for P, interface need enable label switch:

```
Switch(config)# interface eth-0-9
Switch(config-if)# no switchport
Switch(config-if)# ip address 11.11.9.2/24
Switch(config-if)# label-switching
Switch(config-if)# exit
Switch(config)# interface eth-0-17
Switch(config-if)# no switchport
Switch(config-if)# ip address 11.11.17.2/24
Switch(config-if)# label-switching
Switch(config-if)# exit
```

Interface configuration for PE2, interface need enable label switch:

```
Switch(config)# interface eth-0-17
Switch(config-if)# no switchport
Switch(config-if)# ip address 11.11.17.3/24
Switch(config-if)# label-switching
Switch(config-if)# exit
Switch(config)# interface eth-0-1
Switch(config-if)# no switchport
Switch(config-if)# ip address 20.20.20.1/24
Switch(config-if)# label-switching
Switch(config-if)# exit
```

step 3 Configure static ftn/ilm

Static ftn for PE1:

```
Switch(config)# mpls ftn-entry 172.22.4.1/24 100 11.11.9.2
```

Static ilm for P:

```
Switch(config)# mpls ilm-entry swap 100 11.11.17.3 200
```

Static ilm for PE2:

```
Switch(config)# mpls ilm-entry php 200 20.20.20.2
```

step 4 Validation

Display the ftn lists on PE1:

```
PE1# show mpls ftn-database
Codes: > - selected FTN, p - stale FTN, B - BGP FTN, K - CLI FTN,
        L - LDP FTN, R - RSVP-TE FTN, S - SNMP FTN, I - IGP-Shortcut,
        U - unknown FTN
```

Code	FEC	Out-Label	Nexthop	Out-Intf
K>	172.22.4.0/24	100	11.11.9.2	eth-0-9

Display the ilm lists on P:

```
P# show mpls ilm-database
Codes: > - selected ILM, p - stale ILM, B - BGP ILM, K - CLI ILM,
      L - LDP ILM, R - RSVP-TE ILM, S - SNMP ILM, I - IGP-Shortcut,
      U - unknown ILM
```

Code	FEC	I/O Label	Nexthop	Out-Intf
K>	0.0.0.0/0	100/200	11.11.17.3	eth-0-17

Display the ilm lists on PE2:

```
PE2# show mpls ilm-database
Codes: > - selected ILM, p - stale ILM, B - BGP ILM, K - CLI ILM,
      L - LDP ILM, R - RSVP-TE ILM, S - SNMP ILM, I - IGP-Shortcut,
      U - unknown ILM
```

Code	FEC	I/O Label	Nexthop	Out-Intf
K>	0.0.0.0/0	200/3	20.20.20.2	eth-0-1

19.2.3 Application cases

N/A

19.3 Configuring VPLS

19.3.1 Overview

Function Introduction

This chapter describes how to configure VPLS. Virtual Private LAN Service (VPLS) provides a way to enable transparent Layer-2 Ethernet LAN services to geographically dispersed customer sites connected by a Wide Area Network (WAN) by providing support for traditional Layer-2 broadcast and multicast services.

Principle Description

N/A

19.3.2 Configuration

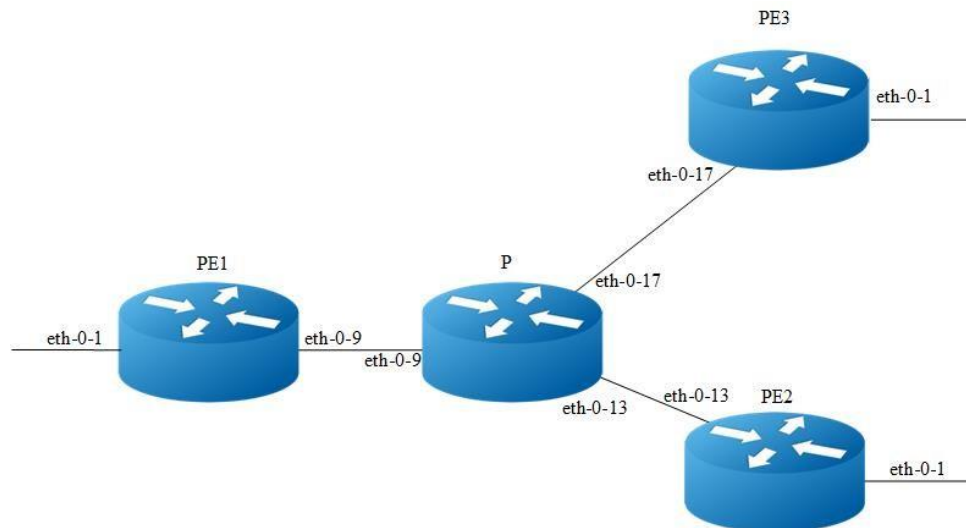

Figure 19-3 VPLS model

Configuring VPLS using LDP

The following example will describe how to use LDP to configure VPLS:

The following configuration should be operated on all switches if the switch ID is not specified.

step 1 Enter the configure mode

```
Switch# configure terminal
```

step 2 Enter the interface configure mode and set the attributes of the interface

Interface configuration for PE1, eth-0-9 need enable ldp and enable label switch:

```
Switch(config)# interface eth-0-9
Switch(config-if)# no switchport
Switch(config-if)# ip address 11.11.9.1/24
Switch(config-if)# enable-ldp
Switch(config-if)# label-switching
Switch(config-if)# exit
Switch(config)# interface loopback 0
Switch(config-if)# ip address 11.11.1.1/32
Switch(config-if)# exit
```

Interface configuration for PE2, eth-0-13 need enable ldp and enable label switch:

```
Switch(config)# interface eth-0-13
Switch(config-if)# no switchport
Switch(config-if)# ip address 11.11.13.4/24
Switch(config-if)# enable-ldp
Switch(config-if)# label-switching
Switch(config-if)# exit
Switch(config)# interface loopback 0
Switch(config-if)# ip address 11.11.4.4/32
Switch(config-if)# exit
```

Interface configuration for PE3, eth-0-17 need enable ldp and enable label switch:

```
Switch(config)# interface eth-0-17
Switch(config-if)# no switchport
Switch(config-if)# ip address 11.11.17.3/24
Switch(config-if)# enable-ldp
Switch(config-if)# label-switching
Switch(config-if)# exit
Switch(config)# interface loopback 0
Switch(config-if)# ip address 11.11.3.3/32
Switch(config-if)# exit
```

Interface configuration for P, interface need enable ldp and enable label switch:

```
Switch(config)# interface eth-0-9
Switch(config-if)# no switchport
Switch(config-if)# ip address 11.11.9.2/24
Switch(config-if)# enable-ldp
Switch(config-if)# label-switching
Switch(config-if)# exit
Switch(config)# interface eth-0-13
Switch(config-if)# no switchport
Switch(config-if)# ip address 11.11.13.2/24
Switch(config-if)# enable-ldp
Switch(config-if)# label-switching
Switch(config-if)# exit
Switch(config)# interface eth-0-17
Switch(config-if)# no switchport
Switch(config-if)# ip address 11.11.17.2/24
Switch(config-if)# enable-ldp
Switch(config-if)# label-switching
Switch(config-if)# exit
Switch(config)# interface loopback 0
Switch(config-if)# ip address 11.11.2.2/32
Switch(config-if)# exit
```

step 3 Enable router ldp

LDP configuration for PE1:

```
Switch(config)# router ldp
Switch(config-router)# router-id 11.11.1.1
Switch(config-router)# targeted-peer 11.11.3.3
Switch(config-router)# targeted-peer 11.11.4.4
```

```
Switch(config-router)# transport-address 11.11.1.1
Switch(config-router)# exit
```

LDP configuration for PE2:

```
Switch(config)# router ldp
Switch(config-router)# router-id 11.11.4.4
Switch(config-router)# transport-address 11.11.4.4
Switch(config-router)# targeted-peer 11.11.1.1
Switch(config-router)# targeted-peer 11.11.3.3
Switch(config-router)# exit
```

LDP configuration for PE3:

```
Switch(config)# router ldp
Switch(config-router)# router-id 11.11.3.3
Switch(config-router)# transport-address 11.11.3.3
Switch(config-router)# targeted-peer 11.11.1.1
Switch(config-router)# targeted-peer 11.11.4.4
Switch(config-router)# exit
```

LDP configuration for P:

```
Switch(config)# router ldp
Switch(config-router)# router-id 11.11.2.2
Switch(config-router)# exit
```

step 4 Enable router rip

```
Switch(config)# router rip
Switch(config-router)# network 11.11.1.1/16
Switch(config-router)# exit
```

step 5 Create a VPLS instance

Config PE1, PE2 and PE3 VPLS PW raw mode, and assign their vpls peers.

VPLS instance for PE1:

```
Switch(config)# mpls vpls v1 100
Switch(config-vpls)# vpls-peer 11.11.3.3 raw
Switch(config-vpls)# vpls-peer 11.11.4.4 raw
Switch(config-vpls)# exit
```

VPLS instance for PE2:

```
Switch(config)# mpls vpls v4 100
Switch(config-vpls)# vpls-peer 11.11.1.1 raw
Switch(config-vpls)# vpls-peer 11.11.3.3 raw
Switch(config-vpls)# exit
```

VPLS instance for PE3:

```
Switch(config)# mpls vpls v3 100
Switch(config-vpls)# vpls-peer 11.11.1.1 raw
Switch(config-vpls)# vpls-peer 11.11.4.4 raw
Switch(config-vpls)# exit
```

step 6 bind the interface and the VPLS instance

Config AC of PE1, PE2 and PE3 VLAN access mode.

Interface configuration for PE1:

```
Switch(config)# interface eth-0-1
Switch(config-if)# switchport mode trunk
Switch(config-if)# mpls-vpls v1 vlan 2
Switch(config-if)# exit
```

Interface configuration for PE2:

```
Switch(config)# interface eth-0-1
Switch(config-if)# switchport mode trunk
Switch(config-if)# mpls-vpls v4 vlan 2
Switch(config-if)# exit
```

Interface configuration for PE3:

```
Switch(config)# interface eth-0-1
Switch(config-if)# switchport mode trunk
Switch(config-if)# mpls-vpls v3 vlan 2
Switch(config-if)# exit
```

step 7 Exit the configure mode

```
Switch(config)# end
```

step 8 Validation

Use the show ldp session and the show mpls vpls mesh commands respectively to display complete information about the VPLS. Show ldp session command can get LDP peer's state. Show mpls vpls mesh command can get vpls peer's state and the inner labels vpls using. The following are the sample outputs for the show commands displaying VPLS.

Display the result on PE1:

```
PE1# show ldp session
Peer IP Address    IF Name    My Role    State          KeepAlive
11.11.3.3          eth-0-9    Passive    OPERATIONAL    30
11.11.4.4          eth-0-9    Passive    OPERATIONAL    30
11.11.2.2          eth-0-9    Passive    OPERATIONAL    30
PE1# show mpls vpls mesh
```

VPLS-ID	Peer Addr/name	In-Label	Out-Intf	Out-Label	Type	St
100	11.11.3.3/-	32768	eth-0-9	32768	RAW	Up
100	11.11.4.4/-	32773	eth-0-9	32768	RAW	Up

Display the result on PE2 :

```
PE2# show ldp session
```

Peer IP Address	IF Name	My Role	State	KeepAlive
11.11.1.1	eth-0-13	Active	OPERATIONAL	30
11.11.3.3	eth-0-13	Active	OPERATIONAL	30
11.11.2.2	eth-0-13	Passive	OPERATIONAL	30

```
PE2# show mpls vpls mesh
```

VPLS-ID	Peer Addr/name	In-Label	Out-Intf	Out-Label	Type	St
100	11.11.1.1/-	32768	eth-0-13	32773	RAW	Up
100	11.11.3.3/-	32769	eth-0-13	32770	RAW	Up

Display the result on PE3 :

```
PE3# show ldp session
```

Peer IP Address	IF Name	My Role	State	KeepAlive
11.11.1.1	eth-0-17	Active	OPERATIONAL	30
11.11.4.4	eth-0-17	Passive	OPERATIONAL	30
11.11.2.2	eth-0-17	Passive	OPERATIONAL	30

```
PE3# show mpls vpls mesh
```

VPLS-ID	Peer Addr/name	In-Label	Out-Intf	Out-Label	Type	St
100	11.11.1.1/-	32768	eth-0-17	32768	RAW	Up
100	11.11.4.4/-	32770	eth-0-17	32769	RAW	Up

Display the result on P :

```
P# show ldp session
```

Peer IP Address	IF Name	My Role	State	KeepAlive
11.11.1.1	eth-0-9	Active	OPERATIONAL	30
11.11.3.3	eth-0-17	Active	OPERATIONAL	30
11.11.4.4	eth-0-13	Active	OPERATIONAL	30

Configuring VPLS using static command

The following example will describe how to configure static VPLS:

The following configuration should be operated on all switches if the switch ID is not specified.

step 1 Enter the configure mode

```
Switch# configure terminal
```

step 2 Enter the interface configure mode and set the attributes of the interface

Interface configuration for PE1, eth-0-9 need enable label switch:

```
Switch(config)# interface eth-0-9
Switch(config-if)# no switchport
Switch(config-if)# ip address 11.11.9.1/24
Switch(config-if)# label-switching
Switch(config-if)# exit
```

Interface configuration for PE2, eth-0-13 need enable label switch:

```
Switch(config)# interface eth-0-13
Switch(config-if)# no switchport
Switch(config-if)# ip address 11.11.13.1/24
Switch(config-if)# label-switching
Switch(config-if)# exit
```

Interface configuration for PE3, eth-0-17 need enable label switch:

```
Switch(config)# interface eth-0-17
Switch(config-if)# no switchport
Switch(config-if)# ip address 11.11.17.1/24
Switch(config-if)# label-switching
Switch(config-if)# exit
```

Interface configuration for P, eth-0-9, eth-0-13 and eth-0-17 need enable label switch:

```
Switch(config)# interface eth-0-9
Switch(config-if)# no switchport
Switch(config-if)# ip address 11.11.9.2/24
Switch(config-if)# label-switching
Switch(config-if)# exit
Switch(config)# interface eth-0-17
Switch(config-if)# no switchport
Switch(config-if)# ip address 11.11.17.2/24
Switch(config-if)# label-switching
Switch(config-if)# exit
Switch(config)# interface eth-0-13
Switch(config-if)# no switchport
Switch(config-if)# ip address 11.11.13.2/24
Switch(config-if)# label-switching
Switch(config-if)# exit
```

step 3 Configure ftn entry

Interface configuration for PE1:

```
Switch(config)# mpls ftn-entry 11.11.17.1/24 97 11.11.9.2
Switch(config)# mpls ftn-entry 11.11.13.1/24 93 11.11.9.2
```

Interface configuration for PE2:

```
Switch(config)# mpls ftn-entry 11.11.9.1/32 44 11.11.13.2
```

Interface configuration for PE3:

```
Switch(config)# mpls ftn-entry 11.11.9.1/32 33 11.11.17.2
```

step 4 Create a VPLS instance

Config PE1, PE2 and PE3 VPLS PW raw mode, and assign their vpls peers.

VPLS instance for PE1:

```
Switch(config)# mpls vpls vpls1 1
Switch(config-vpls)# vpls-peer 11.11.17.1 raw manual
Switch(config-vpls)# vpls-peer 11.11.13.1 raw manual
```

VPLS instance for PE2:

```
Switch(config)# mpls vpls vpls1 1
Switch(config-vpls)# vpls-peer 11.11.9.1 raw manual
```

VPLS instance for PE3:

```
Switch(config)# mpls vpls vpls1 1
Switch(config-vpls)# vpls-peer 11.11.9.1 raw manual
```

step 5 bind the interface and the VPLS instance

Config AC of PE1, PE2 and PE3 VLAN access mode.

Interface configuration for PE1:

```
Switch(config)# interface eth-0-1
Switch(config-if)# switchport mode trunk
Switch(config-if)# mpls-vpls vpls1 vlan 100
Switch(config-if)# exit
```

Interface configuration for PE2:

```
Switch(config)# interface eth-0-1
Switch(config-if)# switchport mode trunk
Switch(config-if)# mpls-vpls vpls1 vlan 100
Switch(config-if)# exit
```

Interface configuration for PE3:

```
Switch(config)# interface eth-0-1
Switch(config-if)# switchport mode trunk
Switch(config-if)# mpls-vpls vpls1 vlan 100
Switch(config-if)# exit
```

step 6 Configure VPLS FIB

VPLS FIB for PE1:

```
Switch(config)# vpls-fib-add vpls1 peer 11.11.17.1 103 31
Switch(config)# vpls-fib-add vpls1 peer 11.11.13.1 102 201
```

VPLS FIB for PE2:

```
Switch(config)# vpls-fib-add vpls1 peer 11.11.9.1 201 102
```

VPLS FIB for PE3:

```
Switch(config)# vpls-fib-add vpls1 peer 11.11.9.1 31 103
```

step 7 Configure static ilm

Static ilm for P:

```
Switch(config)# mpls ilm-entry php 97 11.11.17.1
Switch(config)# mpls ilm-entry php 93 11.11.13.1
Switch(config)# mpls ilm-entry php 33 11.11.9.1
Switch(config)# mpls ilm-entry php 44 11.11.9.1
```

step 8 Exit the configure mode

```
Switch(config)# end
```

step 9 Validation

Show mpls vpls mesh command can get vpls peer's state and the inner labels vpls using.

Display the result on PE1:

```
PE1# show mpls vpls mesh
```

VPLS-ID	Peer Addr/name	In-Label	Out-Intf	Out-Label	Type	St
1	11.11.13.1/-	102	eth-0-9	201	RAW	Up
1	11.11.17.1/-	103	eth-0-9	31	RAW	Up

Display the result on PE2:

```
PE2# show mpls vpls mesh
```

VPLS-ID	Peer Addr/name	In-Label	Out-Intf	Out-Label	Type	St
1	11.11.9.1/-	201	eth-0-13	102	RAW	Up

Display the result on PE3:

```
PE3# show mpls vpls mesh
```

VPLS-ID	Peer Addr/name	In-Label	Out-Intf	Out-Label	Type	St
1	11.11.9.1/-	31	eth-0-17	103	RAW	Up

Display the result on P:

```
P# show mpls ilm-database
```

Codes: > - selected ILM, p - stale ILM, B - BGP ILM, K - CLI ILM,
L - LDP ILM, R - RSVP-TE ILM, S - SNMP ILM, I - IGP-Shortcut,
U - unknown ILM

Code	FEC	I/O Label	Nexthop	Out-Intf
K>	0.0.0.0/0	33/3	11.11.9.1	eth-0-9
K>	0.0.0.0/0	44/3	11.11.9.1	eth-0-9

```
K> 0.0.0.0/0 93/3 11.11.13.1 eth-0-13
K> 0.0.0.0/0 97/3 11.11.17.1 eth-0-17
```

Configuring Tunnel L2 protocol packets by VPLS

Customers at different sites connected across a service-provider network need to run various Layer 2 protocols to scale their topology to include all remote sites, as well as the local sites. STP must run properly, and build a proper spanning tree that includes the local site and all remote sites across the service-provider infrastructure.

The following example will display how to tunnel STP protocol packets by vpls. Users can configure other L2 protocol packets like that. The following configuration is also based on Figure VPLS model topology.

The following configuration should be operated on all switches if the switch ID is not specified.

step 1 Enter the configure mode

```
Switch# configure terminal
```

step 2 Enable L2 protocol globally

```
Switch(config)# l2protocol enable
```

step 3 Enter the interface configure mode and set the attributes of the interface

Interface configuration for PE1, eth-0-9 need enable ldp and enable label switch:

```
Switch(config)# interface eth-0-9
Switch(config-if)# no switchport
Switch(config-if)# ip address 11.11.9.1/24
Switch(config-if)# enable-ldp
Switch(config-if)# label-switching
Switch(config-if)# exit
Switch(config)# interface loopback 0
Switch(config-if)# ip address 11.11.1.1/32
Switch(config-if)# exit
```

Interface configuration for PE2, eth-0-13 need enable ldp and enable label switch:

```
Switch(config)# interface eth-0-13
Switch(config-if)# no switchport
Switch(config-if)# ip add 11.11.13.4/24
Switch(config-if)# enable-ldp
Switch(config-if)# label-switching
Switch(config-if)# exit
Switch(config)# interface loopback 0
```

```
Switch(config-if)# ip address 11.11.4.4/32
Switch(config-if)# exit
```

Interface configuration for PE3, eth-0-17 need enable ldp and enable label switch:

```
Switch(config)# interface eth-0-17
Switch(config-if)# no switchport
Switch(config-if)# ip address 11.11.17.3/24
Switch(config-if)# enable-ldp
Switch(config-if)# label-switching
Switch(config-if)# exit
Switch(config)# interface loopback 0
Switch(config-if)# ip address 11.11.3.3/32
Switch(config-if)# exit
```

Interface configuration for P, interface need enable ldp and enable label switch:

```
Switch(config)# interface eth-0-9
Switch(config-if)# no switchport
Switch(config-if)# ip address 11.11.9.2/24
Switch(config-if)# enable-ldp
Switch(config-if)# label-switching
Switch(config-if)# exit
Switch(config)# interface eth-0-13
Switch(config-if)# no switchport
Switch(config-if)# ip address 11.11.13.2/24
Switch(config-if)# enable-ldp
Switch(config-if)# label-switching
Switch(config-if)# exit
Switch(config)# interface eth-0-17
Switch(config-if)# no switchport
Switch(config-if)# ip address 11.11.17.2/24
Switch(config-if)# enable-ldp
Switch(config-if)# label-switching
Switch(config-if)# exit
Switch(config)# interface loopback 0
Switch(config-if)# ip address 11.11.2.2/32
Switch(config-if)# exit
```

step 4 Enable router ldp

LDP configuration for PE1:

```
Switch(config)# router ldp
Switch(config-router)# router-id 11.11.1.1
Switch(config-router)# targeted-peer 11.11.3.3
Switch(config-router)# targeted-peer 11.11.4.4
Switch(config-router)# transport-address 11.11.1.1
Switch(config-router)# exit
```

LDP configuration for PE2:

```
Switch(config)# router ldp
Switch(config-router)# router-id 11.11.4.4
Switch(config-router)# transport-address 11.11.4.4
```

```
Switch(config-router)# targeted-peer 11.11.1.1
Switch(config-router)# targeted-peer 11.11.3.3
Switch(config-router)# exit
```

LDP configuration for PE3:

```
Switch(config)# router ldp
Switch(config-router)# router-id 11.11.3.3
Switch(config-router)# transport-address 11.11.3.3
Switch(config-router)# targeted-peer 11.11.1.1
Switch(config-router)# targeted-peer 11.11.4.4
Switch(config-router)# exit
```

LDP configuration for P:

```
Switch(config)# router ldp
Switch(config-router)# router-id 11.11.2.2
Switch(config-router)# exit
```

step 5 Enable router rip

RIP configuration for PE1/PE2/PE3:

```
Switch(config)# router rip
Switch(config-router)# network 11.11.1.1/16
Switch(config-router)# exit
```

step 6 Create a VPLS instance

Config PE1, PE2 and PE3 VPLS PW raw mode, and assign their vpls peers.

VPLS instance for PE1:

```
Switch(config)# mpls vpls v1 100
Switch(config-vpls)# vpls-peer 11.11.3.3 raw
Switch(config-vpls)# vpls-peer 11.11.4.4 raw
Switch(config-vpls)# exit
```

VPLS instance for PE2:

```
Switch(config)# mpls vpls v4 100
Switch(config-vpls)# vpls-peer 11.11.1.1 raw
Switch(config-vpls)# vpls-peer 11.11.3.3 raw
Switch(config-vpls)# exit
```

VPLS instance for PE3:

```
Switch(config)# mpls vpls v3 100
Switch(config-vpls)# vpls-peer 11.11.1.1 raw
Switch(config-vpls)# vpls-peer 11.11.4.4 raw
Switch(config-vpls)# exit
```

step 7 bind the interface and the VPLS instance

Config AC of PE1, PE2 and PE3 ethernet access mode.

Interface configuration for PE1:

```
Switch(config)# interface eth-0-1
Switch(config-if)# mpls-vpls v1 ethernet
Switch(config-if)# l2protocol stp tunnel
Switch(config-if)# exit
```

Interface configuration for PE2:

```
Switch(config)# interface eth-0-1
Switch(config-if)# mpls-vpls v4 ethernet
Switch(config-if)# l2protocol stp tunnel
Switch(config-if)# exit
```

Interface configuration for PE3:

```
Switch(config)# interface eth-0-1
Switch(config-if)# mpls-vpls v3 ethernet
Switch(config-if)# l2protocol stp tunnel
Switch(config-if)# exit
```

step 8 Exit the configure mode

```
Switch(config)# end
```

Configuring static MAC entries for VPLS

In a Virtual Switch Instance (VSI), if a PE receives a packet with an unknown destination MAC address, the PE will flood the packet. User can configure static MAC entries to specify the interface or peer node to which the received packets to be forwarded. The following example shows how to configure static MAC entries for a VSI. The following configuration is based on Figure VPLS model topology.

The following configuration should be operated on all switches if the switch ID is not specified.

step 1 Enter the configure mode

```
Switch# configure terminal
```

step 2 Enter the interface configure mode and set the attributes of the interface

Interface configuration for PE1, eth-0-9 need enable ldp and enable label switch:

```
Switch(config)# interface eth-0-9
Switch(config-if)# no switchport
Switch(config-if)# ip address 11.11.9.1/24
Switch(config-if)# enable-ldp
Switch(config-if)# label-switching
Switch(config-if)# exit
Switch(config)# interface loopback 0
Switch(config-if)# ip address 11.11.1.1/32
Switch(config-if)# exit
```

Interface configuration for PE2, eth-0-13 need enable ldp and enable label switch:

```
Switch(config)# interface eth-0-13
Switch(config-if)# no switchport
Switch(config-if)# ip add 11.11.13.4/24
Switch(config-if)# enable-ldp
Switch(config-if)# label-switching
Switch(config-if)# exit
Switch(config)# interface loopback 0
Switch(config-if)# ip address 11.11.4.4/32
Switch(config-if)# exit
```

Interface configuration for PE3, eth-0-17 need enable ldp and enable label switch:

```
Switch(config)# interface eth-0-17
Switch(config-if)# no switchport
Switch(config-if)# ip address 11.11.17.3/24
Switch(config-if)# enable-ldp
Switch(config-if)# label-switching
Switch(config-if)# exit
Switch(config)# interface loopback 0
Switch(config-if)# ip address 11.11.3.3/32
Switch(config-if)# exit
```

Interface configuration for P, interface need enable ldp and enable label switch:

```
Switch(config)# interface eth-0-9
Switch(config-if)# no switchport
Switch(config-if)# ip address 11.11.9.2/24
Switch(config-if)# enable-ldp
Switch(config-if)# label-switching
Switch(config-if)# exit
Switch(config)# interface eth-0-13
Switch(config-if)# no switchport
Switch(config-if)# ip address 11.11.13.2/24
Switch(config-if)# enable-ldp
Switch(config-if)# label-switching
Switch(config-if)# exit
Switch(config)# interface eth-0-17
Switch(config-if)# no switchport
Switch(config-if)# ip address 11.11.17.2/24
Switch(config-if)# enable-ldp
Switch(config-if)# label-switching
Switch(config-if)# exit
Switch(config)# interface loopback 0
```

```
Switch(config-if)# ip address 11.11.2.2/32
Switch(config-if)# exit
```

step 3 Enable router ldp

LDP configuration for PE1:

```
Switch(config)# router ldp
Switch(config-router)# router-id 11.11.1.1
Switch(config-router)# targeted-peer 11.11.3.3
Switch(config-router)# targeted-peer 11.11.4.4
Switch(config-router)# transport-address 11.11.1.1
Switch(config-router)# exit
```

LDP configuration for PE2:

```
Switch(config)# router ldp
Switch(config-router)# router-id 11.11.4.4
Switch(config-router)# transport-address 11.11.4.4
Switch(config-router)# targeted-peer 11.11.1.1
Switch(config-router)# targeted-peer 11.11.3.3
Switch(config-router)# exit
```

LDP configuration for PE3:

```
Switch(config)# router ldp
Switch(config-router)# router-id 11.11.3.3
Switch(config-router)# transport-address 11.11.3.3
Switch(config-router)# targeted-peer 11.11.1.1
Switch(config-router)# targeted-peer 11.11.4.4
Switch(config-router)# exit
```

LDP configuration for P:

```
Switch(config)# router ldp
Switch(config-router)# router-id 11.11.2.2
Switch(config-router)# exit
```

step 4 Enable router rip

```
Switch(config)# router rip
Switch(config-router)# network 11.11.1.1/16
Switch(config-router)# exit
```

step 5 Create a VPLS instance

Config PE1, PE2 and PE3 VPLS PW raw mode, and assign their vpls peers.

VPLS instance for PE1:

```
Switch(config)# mpls vpls v1 100
Switch(config-vpls)# vpls-peer 11.11.3.3 raw
Switch(config-vpls)# vpls-peer 11.11.4.4 raw
```

```
Switch(config-vpls)# mac-address-table 0000.0000.0001 forward eth-0-1
Switch(config-vpls)# mac-address-table 0000.0000.0003 forward peer 11.11.3.3
Switch(config-vpls)# mac-address-table 0000.0000.0004 forward peer 11.11.4.4
Switch(config-vpls)# exit
```

VPLS instance for PE2:

```
Switch(config)# mpls vpls v4 100
Switch(config-vpls)# vpls-peer 11.11.1.1 raw
Switch(config-vpls)# vpls-peer 11.11.3.3 raw
Switch(config-vpls)# mac-address-table 0000.0000.0004 forward eth-0-1
Switch(config-vpls)# mac-address-table 0000.0000.0001 forward peer 11.11.1.1
Switch(config-vpls)# mac-address-table 0000.0000.0003 forward peer 11.11.3.3
Switch(config-vpls)# exit
```

VPLS instance for PE3:

```
Switch(config)# mpls vpls v3 100
Switch(config-vpls)# vpls-peer 11.11.1.1 raw
Switch(config-vpls)# vpls-peer 11.11.4.4 raw
Switch(config-vpls)# mac-address-table 0000.0000.0003 forward eth-0-1
Switch(config-vpls)# mac-address-table 0000.0000.0001 forward peer 11.11.1.1
Switch(config-vpls)# mac-address-table 0000.0000.0004 forward peer 11.11.4.4
Switch(config-vpls)# exit
```

step 6 bind the interface and the VPLS instance

Config AC of PE1, PE2 and PE3 ethernet access mode.

Interface configuration for PE1:

```
Switch(config)# interface eth-0-1
Switch(config-if)# mpls-vpls v1 ethernet
Switch(config-if)# exit
```

Interface configuration for PE2:

```
Switch(config)# interface eth-0-1
Switch(config-if)# mpls-vpls v4 ethernet
Switch(config-if)# exit
```

Interface configuration for PE3:

```
Switch(config)# interface eth-0-1
Switch(config-if)# mpls-vpls v3 ethernet
Switch(config-if)# exit
```

step 7 Exit the configure mode

```
Switch(config)# end
```

step 8 Validation

Use the `show mac address-table vpls` to display complete information about the VPLS MAC entries. The following are the sample outputs for the show command.

Display the result on PE1:

```
PE1# show mac address-table vpls
vpls      peer          mac           static
v1        eth-0-1       0000.0000.0001 1
v1        11.11.3.3    0000.0000.0003 1
v1        11.11.4.4    0000.0000.0004 1
```

Display the result on PE2:

```
PE2# show mac address-table vpls
vpls      peer          mac           static
v1        eth-0-1       0000.0000.0004 1
v1        11.11.1.1    0000.0000.0001 1
v1        11.11.3.3    0000.0000.0003 1
```

Display the result on PE3:

```
PE3# show mac address-table vpls
vpls      peer          mac           static
v1        eth-0-1       0000.0000.0003 1
v1        11.11.1.1    0000.0000.0001 1
v1        11.11.4.4    0000.0000.0004 1
```

19.3.3 Application cases

N/A

19.4 Configuring VPWS

19.4.1 Overview

Function Introduction

This chapter describes how to configure VPWS. The MPLS L2CIRCUIT is a point-to-point Layer 2 connection transported by means of Multiprotocol Label Switching (MPLS) on the service provider's network. The Layer 2 circuit is transported over a single Label Switched Path (LSP) tunnel between two Provider Edge (PE) routers.

Principle Description

N/A

19.4.2 Configuration

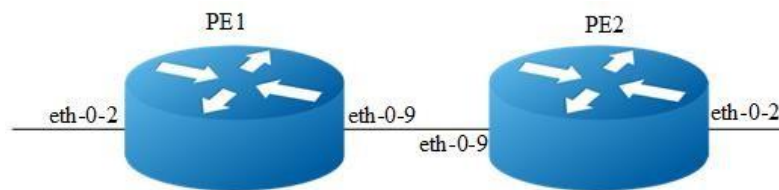

Figure 19-4 Topology of vpws configuration

Configuring VPWS using LDP

The Virtual Circuit module is a part of the LDP module. It is based on the IETF drafts proposed by Martini, et al [L2TRANS]. The Virtual Circuits module sets up virtual circuits for transporting Layer 2 protocols across an MPLS network. This chapter includes a step-by-step configuration of VPWS.

The following configuration should be operated on all switches if the switch ID is not specified.

step 1 Enter the configure mode

```
Switch# configure terminal
```

step 2 Enter the interface configure mode and set the attributes of the interface

Interface configuration for PE1:

```
Switch(config)# interface eth-0-2
Switch(config-if)# mpls-l2-circuit t1 ethernet
Switch(config-if)# exit
Switch(config)# interface loopback 0
Switch(config-if)# ip address 192.168.10.10/32
Switch(config-if)# exit
Switch(config)# interface eth-0-9
Switch(config-if)# no switchport
Switch(config-if)# ip address 8.8.8.1/24
Switch(config-if)# enable-ldp
Switch(config-if)# label-switching
Switch(config-if)# exit
```

Interface configuration for PE2:

```
Switch(config)# interface eth-0-2
Switch(config-if)# mpls-l2-circuit t1 ethernet
Switch(config-if)# exit
Switch(config)# interface loopback 0
Switch(config-if)# ip address 192.168.11.10/32
Switch(config-if)# exit
Switch(config)# interface eth-0-9
Switch(config-if)# no switchport
Switch(config-if)# ip address 8.8.8.2/24
Switch(config-if)# enable-ldp
Switch(config-if)# label-switching
Switch(config-if)# exit
```

step 3 Enable router ldp

LDP configuration for PE1:

```
Switch(config)# router ldp
Switch(config-router)# router-id 192.168.10.10
Switch(config-router)# targeted-peer 192.168.11.10
Switch(config-router)# exit
```

LDP configuration for PE2:

```
PE2(config)# router ldp
PE2(config-router)# router-id 192.168.11.10
PE2(config-router)# targeted-peer 192.168.10.10
PE2(config-router)# exit
```

step 4 Configure VPWS VC ID

VC ID configuration for PE1:

```
PE1(config)# mpls l2-circuit t1 200 192.168.11.10 raw
```

VC ID configuration for PE2:

```
PE2(config)# mpls l2-circuit t1 200 192.168.10.10 raw
```

step 4 Enable router rip

```
Switch(config)# router rip
Switch(config-router)# network 0.0.0.0/0
Switch(config-router)# exit
```

step 5 Exit the configure mode

```
Switch(config)# end
```

step 6 Validation

Use the `show mpls l2-circuit` and the `show mpls vc-table` commands respectively to display complete information about the Layer-2 Virtual Circuit. The following are the sample outputs for the show commands displaying Layer-2 virtual circuit information.

Display the result on PE1: ?

```
PE1# show mpls l2-circuit
VC-Name          VC-ID      Interface  AC-type  VLAN  PW-mode  Manual
t1                200        eth-0-2    Ethernet N/A    Raw    No
PE1# show mpls vc-table
VC-ID    PW Intf  AC Intf  L/R Label    EndPoint    Status  Manual
200      eth-0-9  eth-0-2  32768/32768  192.168.11.10  Active  No
```

Display the result on PE2:

```
PE2# show mpls l2-circuit
VC-Name          VC-ID      Interface  AC-type  VLAN  PW-mode  Manual
t1                200        eth-0-2    Ethernet N/A    Raw    No
PE2# show mpls vc-table
VC-ID    PW Intf  AC Intf  L/R Label    EndPoint    Status  Manual
200      eth-0-9  eth-0-2  32768/32768  192.168.10.10  Active  No
```

VC configuration using static command

The following example will describe how to configure static VPWS

The following configuration should be operated on all switches if the switch ID is not specified.

step 1 Enter the configure mode

```
Switch# configure terminal
```

step 2 Enter the interface configure mode and set the attributes of the interface

Interface configuration for PE1:

```
Switch(config)# interface eth-0-2
Switch(config-if)# mpls-l2-circuit t2 ethernet
Switch(config-if)# exit
Switch(config)# interface loopback 0
Switch(config-if)# ip address 192.168.10.10/32
Switch(config-if)# exit
Switch(config)# interface eth-0-9
Switch(config-if)# no switchport
Switch(config-if)# ip address 8.8.8.1/24
```



```
Switch(config-if)# label-switching
Switch(config-if)# exit
```

Interface configuration for PE3:

```
Switch(config)# interface eth-0-2
Switch(config-if)# mpls-l2-circuit t2 ethernet
Switch(config-if)# exit
Switch(config)# interface loopback 0
Switch(config-if)# ip address 192.168.11.10/32
Switch(config-if)# exit
Switch(config)# interface eth-0-9
Switch(config-if)# no switchport
Switch(config-if)# ip address 8.8.8.2/24
Switch(config-if)# label-switching
Switch(config-if)# exit
```

step 3 Configure ftn entry

FTN entry for PE1:

```
Switch(config)# mpls ftn-entry 192.168.11.1/24 111 8.8.8.2
```

```
FTN          entry          for          PE2:          ?
? Switch(config)# mpls ftn-entry 192.168.10.1/24 222 8.8.8.1
```

step 4 Configure static ilm

Static ilm for PE1:

```
Switch(config)# mpls ilm-entry pop 212
```

Static ilm for PE2:

```
PE2(config)# mpls ilm-entry pop 111
```

step 5 Configure VPWS VC ID

VC ID configuration for PE1:

```
Switch(config)# mpls l2-circuit t2 201 192.168.11.10 raw manual
Switch(config)# mpls l2-circuit-fib-entry t2 44 33
```

VC ID configuration for PE2:

```
Switch(config)# mpls l2-circuit t2 201 192.168.10.10 raw manual
Switch(config)# mpls l2-circuit-fib-entry t2 33 44
```

step 6 Exit the configure mode

```
Switch(config)# end
```

step 7 Validation

Use the `show mpls l2circuit` and the `show mpls vc-table` commands respectively to display complete information about the Layer-2 Virtual Circuit. The following are the sample outputs for the show commands displaying Layer-2 virtual circuit information.

Display the result on PE1:

```
PE1# show mpls l2-circuit
VC-Name      VC-ID      Interface  AC-type      VLAN  PW-mode  Manual
t2           201        eth-0-2    Ethernet      N/A   Raw      Yes
PE1# show mpls vc-table
VC-ID      PW Intf  AC Intf  L/R Label      EndPoint      Status  Manual
201        eth-0-9  eth-0-2  44/33          192.168.11.10 Active    Yes
```

Display the result on PE2:

```
PE2# show mpls l2-circuit
VC-Name      VC-ID      Interface  AC-type      VLAN  PW-mode  Manual
t2           201        eth-0-2    Ethernet      N/A   Raw      Yes
PE2# show mpls vc-table
VC-ID      PW Intf  AC Intf  L/R Label      EndPoint      Status  Manual
201        eth-0-9  eth-0-2  33/44          192.168.10.10 Active    Yes
```

Configuring Tunnel L2 protocol packets by VPWS

Customers at different sites connected across a service-provider network need to run various Layer 2 protocols to scale their topology to include all remote sites, as well as the local sites. STP must run properly, and build a proper spanning tree that includes the local site and all remote sites across the service-provider infrastructure. The following example will display how to tunnel STP protocol packets by vpws. Users can configure other L2 protocol packets like that. The following configuration is also based on chart 1.

The following configuration should be operated on all switches if the switch ID is not specified.

step 1 Enter the configure mode

```
Switch# configure terminal
```

step 2 Enable L2 protocol globally

```
Switch(config)# l2protocol enable
```

step 3 Enter the interface configure mode and set the attributes of the interface

Interface configuration for PE1:

```
Switch(config)# interface eth-0-2
Switch(config-if)# mpls-l2-circuit t1 ethernet
Switch(config-if)# l2protocol stp tunnel
Switch(config-if)# exit
Switch(config)# interface loopback 0
Switch(config-if)# ip address 192.168.10.10/32
Switch(config-if)# exit
Switch(config)# interface eth-0-9
Switch(config-if)# no switchport
Switch(config-if)# ip address 8.8.8.1/24
Switch(config-if)# enable-ldp
Switch(config-if)# label-switching
Switch(config-if)# exit
```

Interface configuration for PE2:

```
Switch#configure terminal
Switch(config)# l2protocol enable
Switch(config)# interface eth-0-2
Switch(config-if)# mpls-l2-circuit t1 ethernet
Switch(config-if)# l2protocol stp tunnel
Switch(config-if)# exit
Switch(config)# interface loopback 0
Switch(config-if)# ip address 192.168.11.10/32
Switch(config-if)# exit
Switch(config)# interface eth-0-9
Switch(config-if)# no switchport
Switch(config-if)# ip address 8.8.8.2/24
Switch(config-if)# enable-ldp
Switch(config-if)# label-switching
Switch(config-if)# exit
```

step 4 Enable router ldp

LDP configuration for PE1:

```
Switch(config)# router ldp
Switch(config-router)# router-id 192.168.10.10
Switch(config-router)# targeted-peer 192.168.11.10
Switch(config-router)# exit
```

LDP configuration for PE2:

```
Switch(config)# router ldp
Switch(config-router)# router-id 192.168.11.10
Switch(config-router)# targeted-peer 192.168.10.10
Switch(config-router)# exit
```

step 4 Configure VPWS VC ID

VC ID configuration for PE1:

```
switch(config)# mpls l2-circuit t1 200 192.168.11.10 raw
```

VC ID configuration for PE2:

```
switch(config)# mpls l2-circuit t1 200 192.168.10.10 raw
```

step 5 Enable router rip

```
switch(config)# router rip
switch(config-router)# network 0.0.0.0/0
switch(config-router)# exit
```

step 6 Exit the configure mode

```
Switch(config)# end
```

19.4.3 Application cases

N/A

19.5 Configuring MPLS QoS

19.5.1 Overview

Function Introduction

MPLS QoS is the important part of QoS network, which is usually implemented by DiffServ model.

MPLS use labels to take the place of routes, which is powerful, flexible and can satisfy all kinds of requirements.

Principle Description

19.5.2 MPLS LSP Model

MPLS LSP model contain three models: Uniform、Pipe、Short Pipe。

Uniform model: The packets on IP network and MPLS network have the same priority, which means the priority is take effect golbally. On the ingress device, the packets will be added labels and the exp will be mapped from dscp. On the egress device, the dscp of the packets will be mapped from exp.

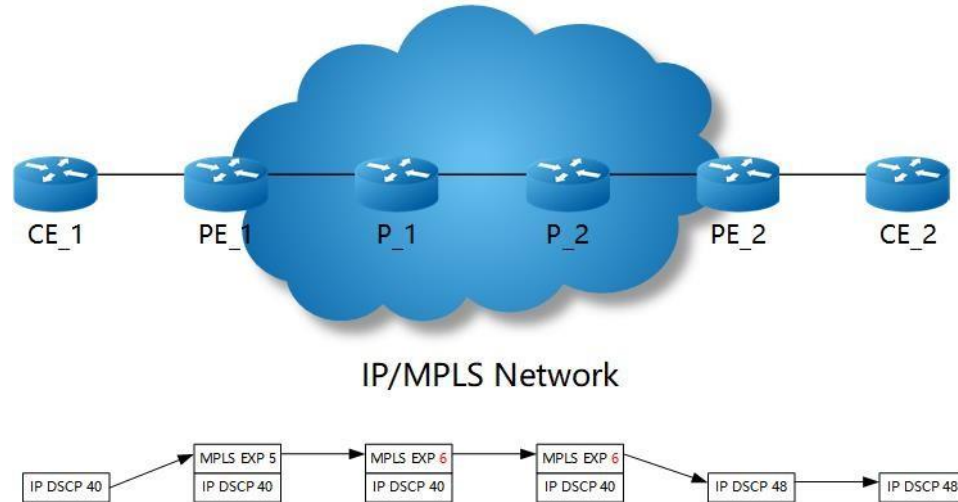

Figure 19-5 Uniform model

Pipe model: On the ingress device, the packets will be added labels and the exp will be assigned by the users. On the egress device, the phb will be mapped from exp and the output packetswill carry the original dscp.

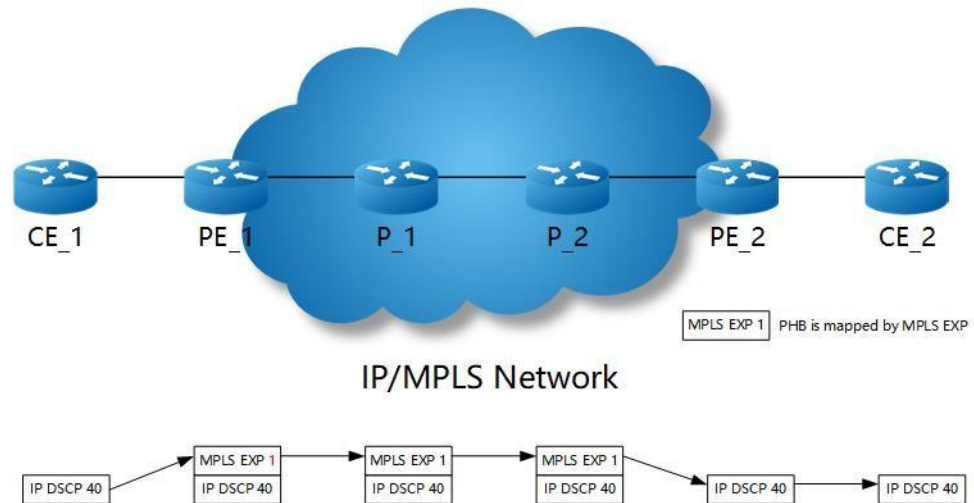

Figure 19-6 Pipe model

Pipe model: On the ingress device, the packets will be added labels and the exp will be assigned by the users. On the egress device, the phb will be mapped from dscp and the output packetswill carry the original dscp.

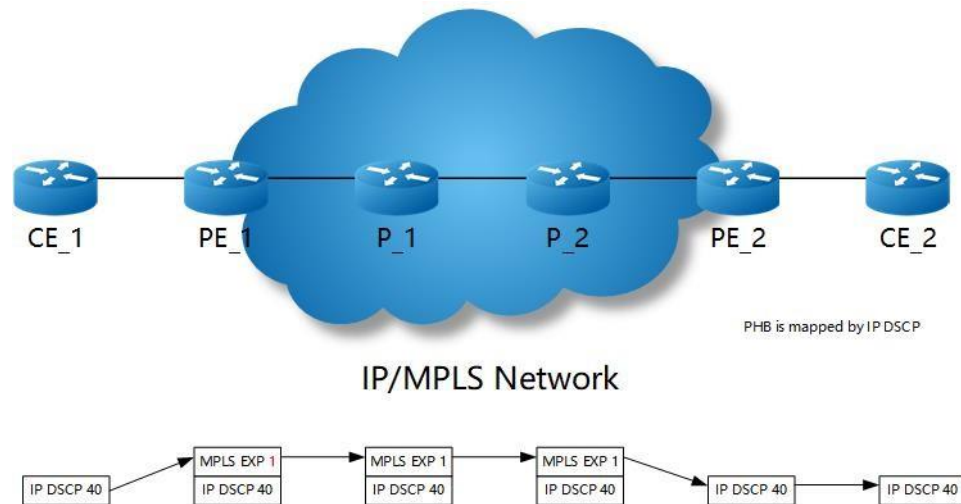

Figure 19-7 Short pipe model

19.5.3 Configuration

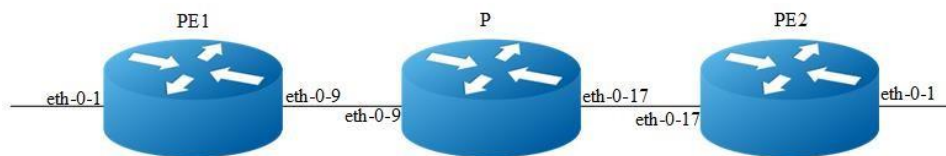

Figure 19-8 MPLS QoS LSP model

MPLS QoS Uniform Configuration

The following example will describe how to configure MPLS QoS Uniform model.

The following configuration should be operated on all switches if the switch ID is not specified.

step 1 Enter the configure mode

```
Switch# configure terminal
```

step 2 Set MPLS LSP Model

```
Switch(config)# mpls lsp-model uniform
```

step 3 Enter the interface configure mode and set the attributes of the interface

Interface configuration for PE1:

```
Switch(config)# interface eth-0-9
Switch(config-if)# no switchport
Switch(config-if)# ip address 10.0.9.1/24
Switch(config-if)# label-switching
Switch(config-if)# exit
Switch(config)# interface eth-0-1
Switch(config-if)# no switchport
Switch(config-if)# qos domain type dscp 1
Switch(config-if)# trust dscp
Switch(config-if)# replace dscp
Switch(config-if)# ip address 1.1.1.1/24
Switch(config-if)# label-switching
Switch(config-if)# exit
```

Interface configuration for P:

```
Switch(config)# interface eth-0-9
Switch(config-if)# no switchport
Switch(config-if)# ip address 10.0.9.2/24
Switch(config-if)# label-switching
Switch(config-if)# exit
Switch(config)# interface eth-0-17
Switch(config-if)# no switchport
Switch(config-if)# ip address 10.0.17.2/24
Switch(config-if)# label-switching
Switch(config-if)# exit
```

Interface configuration for PE2:

```
Switch(config)# interface eth-0-17
Switch(config-if)# no switchport
Switch(config-if)# ip address 10.0.17.1/24
Switch(config-if)# label-switching
Switch(config-if)# exit
Switch(config)# interface eth-0-1
Switch(config-if)# no switchport
Switch(config-if)# qos domain type dscp 1
Switch(config-if)# trust dscp
Switch(config-if)# replace dscp
Switch(config-if)# ip address 2.2.2.2/24
Switch(config-if)# label-switching
Switch(config-if)# exit
```

step 4 Configure static arp

Interface configuration for PE1:

```
Switch(config)# arp 1.1.1.2 0001.0001.0002
```

Interface configuration for PE2:

```
Switch(config)# arp 2.2.2.1 0002.0002.0001
```

step 5 Configure static ftn/ilm

Static ftn for PE1:

```
Switch(config)# mpls ftn-entry 2.2.2.0/24 102 10.0.9.2
Switch(config)# mpls ilm-entry pop 201
```

Static ilm for P:

```
Switch(config)# mpls ilm-entry swap 102 10.0.17.1 203
Switch(config)# mpls ilm-entry swap 302 10.0.9.1 201
```

Static ilm for PE2:

```
Switch(config)# mpls ftn-entry 1.1.1.0/24 302 10.0.17.2
Switch(config)# mpls ilm-entry pop 203
```

step 6 Validation

Display the result on PE1:

```
PE1# show mpls ftn-database
Codes: > - selected FTN, p - stale FTN, B - BGP FTN, K - CLI FTN,
       L - LDP FTN, R - RSVP-TE FTN, S - SNMP FTN, I - IGP-Shortcut,
       * -bypass FTN, U - unknown FTN

Code      FEC                Out-Label    Nexthop      Out-Intf
K>        2.2.2.0/24         102          10.0.9.2     eth-0-9

PE1# show mpls ilm-database
Codes: > - selected ILM, * - LSP ILM, p - stale ILM, B - BGP ILM, K - CLI ILM,
       L - LDP ILM, R - RSVP-TE ILM, S - SNMP ILM, I - IGP-Shortcut
       U - unknown ILM

Code      FEC                I/O Label    Nexthop      Out-Intf
K>        0.0.0.0/0          201/-        0.0.0.0      N/A
```

Display the result on P:

```
P# show mpls ilm-database
Codes: > - selected ILM, * - LSP ILM, p - stale ILM, B - BGP ILM, K - CLI ILM,
       L - LDP ILM, R - RSVP-TE ILM, S - SNMP ILM, I - IGP-Shortcut
       U - unknown ILM

Code      FEC                I/O Label    Nexthop      Out-Intf
K>        0.0.0.0/0          102/203     10.0.17.1    eth-0-17
K>        0.0.0.0/0          302/201     10.0.9.1     eth-0-9
```

Display the result on PE2:

```
PE2# show mpls ftn-database
Codes: > - selected FTN, p - stale FTN, B - BGP FTN, K - CLI FTN,
       L - LDP FTN, R - RSVP-TE FTN, S - SNMP FTN, I - IGP-Shortcut,
       * -bypass FTN, U - unknown FTN
```



```

Code      FEC                Out-Label  Nexthop    Out-Intf
K>        1.1.1.0/24          302        10.0.17.2  eth-0-17

PE2# show mpls ilm-database
Codes: > - selected ILM, * - LSP ILM, p - stale ILM, B - BGP ILM, K - CLI ILM,
      L - LDP ILM, R - RSVP-TE ILM, S - SNMP ILM, I - IGP-Shortcut
      U - unknown ILM

Code      FEC                I/O Label  Nexthop    Out-Intf
K>        0.0.0.0/0          203/-      0.0.0.0    N/A

```

MPLS QoS Pipe Configuration

The following example will describe how to configure MPLS QoS Pipe model.

The following configuration should be operated on all switches if the switch ID is not specified.

step 1 Enter the configure mode

```
Switch# configure terminal
```

step 2 Set MPLS LSP Model

Interface configuration for PE1:

```
Switch(config)# mpls lsp-model pipe exp 7
```

Interface configuration for P:

```
Switch(config)# mpls lsp-model pipe
```

Interface configuration for PE2:

```
Switch(config)# mpls lsp-model pipe exp 7
```

step 3 Enter the interface configure mode and set the attributes of the interface

Interface configuration for PE1:

```

Switch(config)# interface eth-0-9
Switch(config-if)# no switchport
Switch(config-if)# ip address 10.0.9.1/24
Switch(config-if)# label-switching
Switch(config-if)# exit
Switch(config)# interface eth-0-1
Switch(config-if)# no switchport
Switch(config-if)# qos domain type dscp 1
Switch(config-if)# trust dscp

```

```
Switch(config-if)# ip address 1.1.1.1/24
Switch(config-if)# label-switching
Switch(config-if)# exit
```

Interface configuration for P:

```
Switch(config)# interface eth-0-9
Switch(config-if)# no switchport
Switch(config-if)# ip address 10.0.9.2/24
Switch(config-if)# label-switching
Switch(config-if)# exit
Switch(config)# interface eth-0-17
Switch(config-if)# no switchport
Switch(config-if)# ip address 10.0.17.2/24
Switch(config-if)# label-switching
Switch(config-if)# exit
```

Interface configuration for PE2:

```
Switch(config)# interface eth-0-17
Switch(config-if)# no switchport
Switch(config-if)# ip address 10.0.17.1/24
Switch(config-if)# label-switching
Switch(config-if)# exit
Switch(config)# interface eth-0-1
Switch(config-if)# no switchport
Switch(config-if)# qos domain type dscp 1
Switch(config-if)# trust dscp
Switch(config-if)# ip address 2.2.2.2/24
Switch(config-if)# label-switching
Switch(config-if)# exit
```

step 4 Configure static arp

Interface configuration for PE1:

```
Switch(config)# arp 1.1.1.2 0001.0001.0002
```

Interface configuration for PE2:

```
Switch(config)# arp 2.2.2.1 0002.0002.0001
```

step 5 Configure static ftn/ilm

Static ftn for PE1:

```
Switch(config)# mpls ftn-entry 2.2.2.0/24 102 10.0.9.2
Switch(config)# mpls ilm-entry pop 201
```

Static ilm for P:

```
Switch(config)# mpls ilm-entry swap 102 10.0.17.1 203
Switch(config)# mpls ilm-entry swap 302 10.0.9.1 201
```

Static ilm for PE2:

```
Switch(config)# mpls ftn-entry 1.1.1.0/24 302 10.0.17.2
Switch(config)# mpls ilm-entry pop 203
```

step 6 Validation**Display the result on PE1:**

```
PE1# show mpls ftn-database
Codes: > - selected FTN, p - stale FTN, B - BGP FTN, K - CLI FTN,
      L - LDP FTN, R - RSVP-TE FTN, S - SNMP FTN, I - IGP-Shortcut,
      * -bypass FTN, U - unknown FTN

Code      FEC                Out-Label    Nexthop      Out-Intf
K>        2.2.2.0/24          102          10.0.9.2     eth-0-9

PE1# show mpls ilm-database
Codes: > - selected ILM, * - LSP ILM, p - stale ILM, B - BGP ILM, K - CLI ILM,
      L - LDP ILM, R - RSVP-TE ILM, S - SNMP ILM, I - IGP-Shortcut
      U - unknown ILM

Code      FEC                I/O Label    Nexthop      Out-Intf
K>        0.0.0.0/0           201/-        0.0.0.0      N/A
```

Display the result on P:

```
P# show mpls ilm-database
Codes: > - selected ILM, * - LSP ILM, p - stale ILM, B - BGP ILM, K - CLI ILM,
      L - LDP ILM, R - RSVP-TE ILM, S - SNMP ILM, I - IGP-Shortcut
      U - unknown ILM

Code      FEC                I/O Label    Nexthop      Out-Intf
K>        0.0.0.0/0           102/203      10.0.17.1    eth-0-17
K>        0.0.0.0/0           302/201      10.0.9.1     eth-0-9
```

Display the result on PE2:

```
PE2# show mpls ftn-database
Codes: > - selected FTN, p - stale FTN, B - BGP FTN, K - CLI FTN,
      L - LDP FTN, R - RSVP-TE FTN, S - SNMP FTN, I - IGP-Shortcut,
      * -bypass FTN, U - unknown FTN

Code      FEC                Out-Label    Nexthop      Out-Intf
K>        1.1.1.0/24          302          10.0.17.2     eth-0-17

PE2# show mpls ilm-database
Codes: > - selected ILM, * - LSP ILM, p - stale ILM, B - BGP ILM, K - CLI ILM,
      L - LDP ILM, R - RSVP-TE ILM, S - SNMP ILM, I - IGP-Shortcut
      U - unknown ILM

Code      FEC                I/O Label    Nexthop      Out-Intf
K>        0.0.0.0/0           203/-        0.0.0.0      N/A
```

MPLS QoS Short Pipe Configuration

The following example will describe how to configure MPLS QoS Short Pipe model.

The following configuration should be operated on all switches if the switch ID is not specified.

step 1 Enter the configure mode

```
Switch# configure terminal
```

step 2 Set MPLS LSP Model

Interface configuration for PE1:

```
Switch(config)# mpls lsp-model short-pipe exp 7
```

Interface configuration for P:

```
Switch(config)# mpls lsp-model short-pipe
```

Interface configuration for PE2:

```
Switch(config)# mpls lsp-model short-pipe exp 7
```

step 3 Enter the interface configure mode and set the attributes of the interface

Interface configuration for PE1:

```
Switch(config)# interface eth-0-9
Switch(config-if)# no switchport
Switch(config-if)# ip address 10.0.9.1/24
Switch(config-if)# label-switching
Switch(config-if)# exit
Switch(config)# interface eth-0-1
Switch(config-if)# no switchport
Switch(config-if)# qos domain type dscp 1
Switch(config-if)# trust dscp
Switch(config-if)# ip address 1.1.1.1/24
Switch(config-if)# label-switching
Switch(config-if)# exit
```

Interface configuration for P:

```
Switch(config)# interface eth-0-9
Switch(config-if)# no switchport
Switch(config-if)# ip address 10.0.9.2/24
Switch(config-if)# label-switching
Switch(config-if)# exit
Switch(config)# interface eth-0-17
Switch(config-if)# no switchport
```

```
Switch(config-if)# ip address 10.0.17.2/24
Switch(config-if)# label-switching
Switch(config-if)# exit
```

Interface configuration for PE2:

```
Switch(config)# interface eth-0-17
Switch(config-if)# no switchport
Switch(config-if)# ip address 10.0.17.1/24
Switch(config-if)# label-switching
Switch(config-if)# exit
Switch(config)# interface eth-0-1
Switch(config-if)# no switchport
Switch(config-if)# qos domain type dscp 1
Switch(config-if)# trust dscp
Switch(config-if)# ip address 2.2.2.2/24
Switch(config-if)# label-switching
Switch(config-if)# exit
```

step 4 Configure static arp

Interface configuration for PE1:

```
Switch(config)# arp 1.1.1.2 0001.0001.0002
```

Interface configuration for PE2:

```
Switch(config)# arp 2.2.2.1 0002.0002.0001
```

step 5 Configure static ftn/ilm

Static ftn for PE1:

```
Switch(config)# mpls ftn-entry 2.2.2.0/24 102 10.0.9.2
Switch(config)# mpls ilm-entry pop 201
```

Static ilm for P:

```
Switch(config)# mpls ilm-entry swap 102 10.0.17.1 203
Switch(config)# mpls ilm-entry swap 302 10.0.9.1 201
```

Static ilm for PE2:

```
Switch(config)# mpls ftn-entry 1.1.1.0/24 302 10.0.17.2
Switch(config)# mpls ilm-entry pop 203
```

step 6 Validation

Display the result on PE1:

```
PE1# show mpls ftn-database
Codes: > - selected FTN, p - stale FTN, B - BGP FTN, K - CLI FTN,
L - LDP FTN, R - RSVP-TE FTN, S - SNMP FTN, I - IGP-Shortcut,
```

```

* -bypass FTN, U - unknown FTN

Code      FEC                Out-Label    Nexthop      Out-Intf
K>        2.2.2.0/24          102          10.0.9.2     eth-0-9

PE1# show mpls ilm-database
Codes: > - selected ILM, * - LSP ILM, p - stale ILM, B - BGP ILM, K - CLI ILM,
      L - LDP ILM, R - RSVP-TE ILM, S - SNMP ILM, I - IGP-Shortcut
      U - unknown ILM

Code      FEC                I/O Label    Nexthop      Out-Intf
K>        0.0.0.0/0          201/-        0.0.0.0      N/A

```

Display the result on P:

```

P# show mpls ilm-database
Codes: > - selected ILM, * - LSP ILM, p - stale ILM, B - BGP ILM, K - CLI ILM,
      L - LDP ILM, R - RSVP-TE ILM, S - SNMP ILM, I - IGP-Shortcut
      U - unknown ILM

Code      FEC                I/O Label    Nexthop      Out-Intf
K>        0.0.0.0/0          102/203     10.0.17.1    eth-0-17
K>        0.0.0.0/0          302/201     10.0.9.1     eth-0-9

```

Display the result on PE2:

```

PE2# show mpls ftn-database
Codes: > - selected FTN, p - stale FTN, B - BGP FTN, K - CLI FTN,
      L - LDP FTN, R - RSVP-TE FTN, S - SNMP FTN, I - IGP-Shortcut,
      * -bypass FTN, U - unknown FTN

Code      FEC                Out-Label    Nexthop      Out-Intf
K>        1.1.1.0/24          302          10.0.17.2    eth-0-17

PE2# show mpls ilm-database
Codes: > - selected ILM, * - LSP ILM, p - stale ILM, B - BGP ILM, K - CLI ILM,
      L - LDP ILM, R - RSVP-TE ILM, S - SNMP ILM, I - IGP-Shortcut
      U - unknown ILM

Code      FEC                I/O Label    Nexthop      Out-Intf
K>        0.0.0.0/0          203/-        0.0.0.0      N/A

```

19.5.4 Application cases

N/A

19.6 Configuring L3VPN

19.6.1 Overview

Function Introduction

This chapter describes how to configure L3VPN. It uses Route Target's community to control route sending and receiving. RD is used to distinguish which VPN the route from. The inner label is used to map the different vrf, then through the vrf to guide packet forwarding.

Principle Description

N/A

19.6.2 Configuration

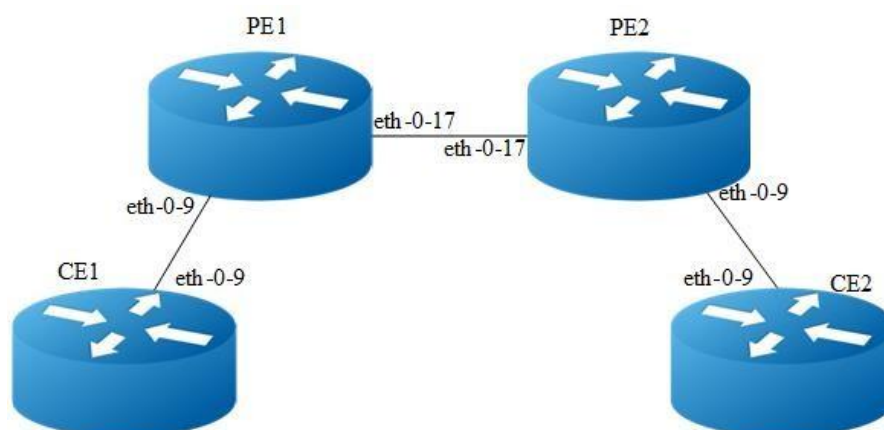

Figure 19-9 L3VPN mode

Configuring L3VPN

The following example will describe how to configure L3VPN:

The following configuration should be operated on all switches if the switch ID is not specified.

step 1 Enter the configure mode

```
Switch# configure terminal
```

step 2 Set vrf

Vrf configuration for PE1:

```
Switch(config)# ip vrf vpn1
Switch(config-vrf)# rd 1:1
Switch(config-vrf)# route-target both 1:1
Switch(config-vrf)# exit
```

Vrf configuration for PE2:

```
Switch(config)# ip vrf vpn1
Switch(config-vrf)# rd 1:1
Switch(config-vrf)# route-target both 1:1
Switch(config-vrf)# exit
```

step 3 Enter the interface configure mode and set the attributes of the interface

Interface configuration for CE1:

```
Switch(config)# interface eth-0-9
Switch(config-if)# no switchport
Switch(config-if)# ip address 2.2.2.1/24
Switch(config-if)# exit
Switch(config)# interface loopback 0
Switch(config-if)# ip address 4.4.4.4/32
Switch(config-if)# exit
```

Interface configuration for PE1, eth-0-9 need enable ldp and join vrf:

```
Switch(config)# interface eth-0-9
Switch(config-if)# no switchport
Switch(config-if)# ip vrf forwarding vpn1
Switch(config-if)# ip address 2.2.2.2/24
Switch(config-if)# exit
Switch(config)# interface eth-0-17
Switch(config-if)# no switchport
Switch(config-if)# label-switching
Switch(config-if)# ip address 1.1.1.1/24
Switch(config-if)# enable-ldp
Switch(config-if)# exit
Switch(config)# interface loopback 0
Switch(config-if)# ip address 5.5.5.5/32
Switch(config-if)# exit
```

Interface configuration for PE2, eth-0-9 need enable ldp and join vrf:

```
Switch(config)# interface eth-0-9
Switch(config-if)# no switchport
```



```
Switch(config-if)# ip vrf forwarding vpn1
Switch(config-if)# ip address 3.3.3.3/24
Switch(config-if)# exit
Switch(config)# interface eth-0-17
Switch(config-if)# no switchport
Switch(config-if)# label-switching
Switch(config-if)# ip address 1.1.1.2/24
Switch(config-if)# enable-ldp
Switch(config-if)# exit
Switch(config)# interface loopback 0
Switch(config-if)# ip address 6.6.6.6/32
Switch(config-if)# exit
```

Interface configuration for CE2:

```
Switch(config)# interface eth-0-9
Switch(config-if)# no switchport
Switch(config-if)# ip address 3.3.3.4/24
Switch(config-if)# exit
Switch(config)# interface loopback0
Switch(config-if)# ip address 7.7.7.7/32
Switch(config-if)# exit
```

step 4 Enable router ldp

LDP configuration for PE1:

```
Switch(config)# router ldp
Switch(config-router)# router-id 5.5.5.5
Switch(config-router)# exit
```

LDP configuration for PE2:

```
Switch(config)# router ldp
Switch(config-router)# router-id 6.6.6.6
Switch(config-router)# exit
```

step 5 Enable router rip

RIP configuration for CE1:

```
Switch(config)# router rip
Switch(config-router)# network 2.2.2.2/24
Switch(config-router)# redistribute connected
Switch(config-router)# exit
```

RIP configuration for PE1:

```
Switch(config)# router rip
Switch(config-router)# address-family ipv4 vrf vpn1
Switch(config-router-af)# network 2.2.2.0/24
Switch(config-router-af)# redistribute bgp
Switch(config-router-af)# exit-address-family
Switch(config-router)# exit
```

RIP configuration for PE2:

```
Switch(config)# router rip
Switch(config-router)# address-family ipv4 vrf vpn1
Switch(config-router-af)# network 3.3.3.3/24
Switch(config-router-af)# redistribute bgp
Switch(config-router-af)# exit-address-family
Switch(config-router)# exit
```

RIP configuration for CE2:

```
Switch(config)# router rip
Switch(config-router)# network 3.3.3.0/24
Switch(config-router)# redistribute connected
Switch(config-router)# exit
```

step 6 Enable router ospf

OSPF configuration for PE1:

```
Switch(config)#router ospf
Switch(config-router)# redistribute connected
Switch(config-router)# network 1.1.1.0/24 area 0
Switch(config-router)# exit
```

OSPF configuration for PE2:

```
Switch(config)# router ospf
Switch(config-router)# redistribute connected
Switch(config-router)# network 1.1.1.0/24 area 0
Switch(config-router)# exit
```

step 7 Enable router bgp

BGP configuration for PE1:

```
Switch(config)# router bgp 1
Switch(config-router)# neighbor 6.6.6.6 remote-as 1
Switch(config-router)# neighbor 6.6.6.6 update-source loopback0
Switch(config-router)# address-family ipv4
Switch(config-router-af)# no synchronization
Switch(config-router-af)# neighbor 6.6.6.6 activate
Switch(config-router-af)# exit-address-family
Switch(config-router)# address-family vpnv4 unicast
Switch(config-router-af)# no synchronization
Switch(config-router-af)# neighbor 6.6.6.6 activate
Switch(config-router-af)# neighbor 6.6.6.6 send-community both
Switch(config-router-af)# exit-address-family
Switch(config-router)# address-family ipv4 vrf vpn1
Switch(config-router-af)# redistribute connected
Switch(config-router-af)# redistribute rip
Switch(config-router-af)# no synchronization
```

```
Switch(config-router-af)# exit-address-family
Switch(config-router)# exit
```

BGP configuration for PE2:

```
Switch(config)# router bgp 1
Switch(config-router)# neighbor 5.5.5.5 remote-as 1
Switch(config-router)# neighbor 5.5.5.5 update-source loopback0
Switch(config-router)# address-family ipv4
Switch(config-router-af)# no synchronization
Switch(config-router-af)# neighbor 5.5.5.5 activate
Switch(config-router-af)# exit-address-family
Switch(config-router)# address-family vpnv4 unicast
Switch(config-router-af)# no synchronization
Switch(config-router-af)# neighbor 5.5.5.5 activate
Switch(config-router-af)# neighbor 5.5.5.5 send-community both
Switch(config-router-af)# exit-address-family
Switch(config-router)# address-family ipv4 vrf vpn1
Switch(config-router-af)# redistribute connected
Switch(config-router-af)# redistribute rip
Switch(config-router-af)# no synchronization
Switch(config-router-af)# exit-address-family
Switch(config-router)# exit
```

step 8 Validation

Use show ip route command and ping CE2 loopback address to validate the l3vpn is worked.

Display the result on PE1:

```
PE1# show ip route
s: K - kernel, C - connected, S - static, R - RIP, B - BGP
  O - OSPF, IA - OSPF inter area
  N1 - OSPF NSSA external type 1, N2 - OSPF NSSA external type 2
  E1 - OSPF external type 1, E2 - OSPF external type 2
  i - IS-IS, L1 - IS-IS level-1, L2 - IS-IS level-2, ia - IS-IS inter area
  Dc - DHCP Client
  [*] - [AD/Metric]
  * - candidate default

C       2.2.2.0/24 is directly connected, eth-0-9
C       2.2.2.1/32 is in local loopback, eth-0-9
R       3.3.3.0/24 [120/2] via 2.2.2.2, eth-0-9, 00:00:04
C       4.4.4.4/32 is directly connected, loopback0
R       7.7.7.7/32 [120/2] via 2.2.2.2, eth-0-9, 00:00:02

PE1# ping 7.7.7.7
PING 7.7.7.7 (7.7.7.7) 56(84) bytes of data.
64 bytes from 7.7.7.7: icmp_seq=0 ttl=62 time=1828 ms
64 bytes from 7.7.7.7: icmp_seq=1 ttl=62 time=1801 ms
64 bytes from 7.7.7.7: icmp_seq=2 ttl=62 time=1775 ms
64 bytes from 7.7.7.7: icmp_seq=3 ttl=62 time=1775 ms
64 bytes from 7.7.7.7: icmp_seq=4 ttl=62 time=1705 ms
```

```
--- 7.7.7.7 ping statistics ---
5 packets transmitted, 5 received, 0% packet loss, time 4018ms
rtt min/avg/max/mdev = 1705.600/1777.267/1828.148/40.840 ms, pipe 3
```

19.6.3 Application cases

N/A

19.7 Configuring MPLS SR

19.7.1 Overview

Function Introduction

Segment Routing uses the source path selection mechanism to encapsulate the SID to be allocated by the node at the source node in advance. When the message passes through the SR node, the node forwards the message according to the SID of the message. Except the source node, other nodes do not need to maintain the path state. MPLS SR refers to the use of SR in the MPLS network to forward message as SID.

Principle Description

In order to forward message through SR LSP, the following tasks need to be completed:

- Assign labels. In order to plan label information for each node and link in the message forwarding path, static segment configuration or dynamic SID allocation can be used.
- Create a label forwarding table entry. Device in the segment routing domain composed of devices running MPLS SR form local label forwarding table entries according to be allocated label information.
- Establish SR LSP. SR LSP can be configured manually or created dynamically through the controller.
- SR tunnel is associated with SR LSP so that SR LSP can be used for message forwarding.

After the above steps are completed, when the source node receives the user network message, it will encapsulate the label information on the pass through which

the message passes, and forward the message to the tail node through SR LSP. After receiving the message from SR LSP, the tail node will strip the label in the message and forward the message according to the destination address lookup routing table of the original table.

19.7.2 Configuration

Static MPLS SR Configuration

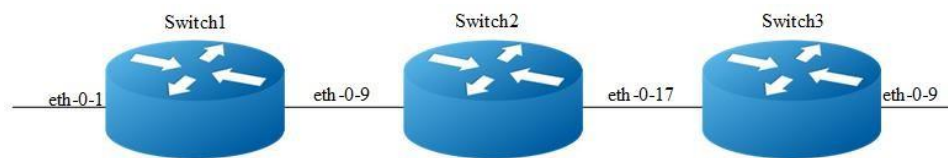

Figure 19-10 MPLS LSP Topo

The following example will describe how to configure static MPLS SR.

step 1 Enter the configure mode

```
Switch# configure terminal
```

step 2 Enter the interface configure mode and set the attributes of the interface

Interface configuration on switch1:

```
Switch(config)# interface eth-0-1
Switch(config-if)# no switchport
Switch(config-if)# no shutdown
Switch(config-if)# ip address 1.1.1.1/24
Switch(config-if)# exit
Switch(config)# interface eth-0-9
Switch(config-if)# no switchport
Switch(config-if)# no shutdown
Switch(config-if)# ip address 12.1.1.1/24
Switch(config-if)# label-switching
Switch(config-if)# exit
```

Interface configuration on switch2:

```
Switch(config)# interface eth-0-9
Switch(config-if)# no switchport
Switch(config-if)# no shutdown
Switch(config-if)# ip address 12.1.1.2/24
Switch(config-if)# label-switching
Switch(config-if)# exit
Switch(config)# interface eth-0-17
```

```
Switch(config-if) # no switchport
Switch(config-if) # no shutdown
Switch(config-if) # ip address 23.1.1.2/24
Switch(config-if) # label-switching
Switch(config-if) # exit
```

Interface configuration on switch3:

```
Switch(config) # interface eth-0-17
Switch(config-if) # no switchport
Switch(config-if) # no shutdown
Switch(config-if) # ip address 23.1.1.3/24
Switch(config-if) # label-switching
Switch(config-if) # exit
Switch(config) # interface eth-0-9
Switch(config-if) # no switchport
Switch(config-if) # no shutdown
Switch(config-if) # ip address 34.1.1.3/24
Switch(config-if) # label-switching
Switch(config-if) # exit
Switch(config) # interface loopback0
Switch(config-if) # ip address 5.5.5.5/32
Switch(config-if) # exit
```

step 3 Configure static route

Static route configuration on switch2:

```
Switch(config) # ip route 5.5.5.5/32 23.1.1.3
```

Static route and static arp configuration on switch3:

```
Switch(config) # arp 34.1.1.4 0000.0000.000a
Switch(config) # ip route 10.10.10.10/32 34.1.1.4
```

step 4 Configure segment statically

Adj segment configuration on switch1:

```
Switch(config) # static-sr-mpls adjacency adj1 in-label 20 nexthop 12.1.1.2
```

Prefix segment configuration on switch2:

```
Switch(config) # static-sr-mpls prefix prefix1 destination 5.5.5.5/32 in-label 30
nexthop 23.1.1.3 out-label 30
```

Prefix segment configuration on switch3:

```
Switch(config) # static-sr-mpls prefix prefix1 destination 5.5.5.5/32 in-label 30
```

step 5 Configure SR LSP

Sr lsp configuration on switch1:

```
Switch(config)# static-sr-mpls lsp lsp1 out-label 20 30
```

step 6 Configure SR TUNNEL , bind sr lsp to tunnel and map route to sr tunnel

Sr lsp configuration on switch1:

```
Switch(config)# static-sr-mpls tunnel tun1 non-aps
Switch(config-sr-tunnel)# primary lsp1
Switch(config-sr-tunnel)# map-route 10.10.10.10/32
Switch(config-sr-tunnel)# exit
```

step 7 Validation

Display the adj segment on switch1:

```
Switch# show mpls sr-adj
sr-adj          id    inlabel  nexthop      lsp_list
adj1            0     20      12.1.1.2     lsp1
```

Display the prefix segment on switch2:

```
Switch# show mpls sr-prefix
sr-prefix      id    inlabel  outlabel  nexthop      lsp_list
prefix1       0     30      30       23.1.1.3
```

Display the prefix segment on switch3:

```
Switch# show mpls sr-prefix
sr-prefix      id    inlabel  outlabel  nexthop      lsp_list
prefix1       0     30      1048576  0.0.0.0
```

Display the sr lsp on switch1:

```
Switch# show mpls sr-lsp
sr-lsp    id    tunid  inst1  nexthop      tunnel  adj    prefix  outlabel
lsp1     2     2      1     12.1.1.2     tun1   adj1   -       20 30
```

Display the sr tunnel on switch1:

```
Switch# show mpls sr-tunnel
sr-tunnel    id    type  wlsp    plsp    slsp    map-route
tun1         3     non   lsp1    -       -       10.10.10.10/32
```

Display the map-route on switch1:

```
Switch# show mpls sr-mapped-routes
Mapped-route  SR Tunnel name
10.10.10.10/32  tun1
```

Send packets with destination ip address 10.10.10.10 to eth-0-1 on switch1:

Capture packets received on eth-0-1 on switch1:

```
07:45:48.915852 00:00:00:00:00:02 (oui Ethernet) > 22:92:11:2e:47:00 (oui Unknown),
ethertype IPv4 (0x0800), length 64: (tos 0x0, ttl 10, id 0, offset 0, flags [none],
proto UDP (17), length 50)
    1.1.1.3.43690 > 10.10.10.10.43741: [bad udp cksum 0xaadd -> 0x9331!] UDP,
length 43682
    0x0000:  2292 112e 4700 0000 0000 0002 0800 4500
    0x0010:  0032 0000 0000 0a11 9aa4 0101 0103 0a0a
    0x0020:  0a0a aaaa aadd aaaa aadd aaaa aadd aaaa
    0x0030:  aadd aaaa aadd aaaa aadd aaaa aadd aaaa
```

Capture packets sented on eth-0-9 on switch1:

```
07:49:41.883130 22:92:11:2e:47:00 (oui Unknown) > 2c:ad:5e:70:52:00 (oui Unknown),
ethertype MPLS unicast (0x8847), length 68: MPLS (label 30, exp 0, [S], ttl 8)
(tos 0x0, ttl 9, id 0, offset 0, flags [none], proto UDP (17), length 50)
    1.1.1.3.43690 > 10.10.10.10.43741: [bad udp cksum 0xaadd -> 0x9331!] UDP,
length 43682
    0x0000:  2cad 5e70 5200 2292 112e 4700 8847 0001
    0x0010:  e108 4500 0032 0000 0000 0911 9ba4 0101
    0x0020:  0103 0a0a 0a0a aaaa aadd aaaa aadd aaaa
    0x0030:  aadd aaaa aadd aaaa aadd aaaa aadd aaaa
    0x0040:  aadd aaaa
```

Capture packets sented on eth-0-17 on switch2:

```
07:51:36.664252 2c:ad:5e:70:52:00 (oui Unknown) > 4e:1d:de:29:f9:00 (oui Unknown),
ethertype MPLS unicast (0x8847), length 68: MPLS (label 30, exp 0, [S], ttl 7)
(tos 0x0, ttl 9, id 0, offset 0, flags [none], proto UDP (17), length 50)
    1.1.1.3.43690 > 10.10.10.10.43741: [bad udp cksum 0xaadd -> 0x9331!] UDP, length
43682
    0x0000:  4e1d de29 f900 2cad 5e70 5200 8847 0001
    0x0010:  e107 4500 0032 0000 0000 0911 9ba4 0101
    0x0020:  0103 0a0a 0a0a aaaa aadd aaaa aadd aaaa
    0x0030:  aadd aaaa aadd aaaa aadd aaaa aadd aaaa
    0x0040:  aadd aaaa
```

Capture packets sented on eth-0-9 on switch3:

```
07:55:33.886746 4e:1d:de:29:f9:00 (oui Unknown) > 00:00:00:00:00:0a (oui Ethernet),
ethertype IPv4 (0x0800), length 64: (tos 0x0, ttl 6, id 0, offset 0, flags [none],
proto UDP (17), length 50)
    1.1.1.3.43690 > 10.10.10.10.43741: [bad udp cksum 0xaadd -> 0x9331!] UDP,
length 43682
    0x0000:  0000 0000 000a 4e1d de29 f900 0800 4500
    0x0010:  0032 0000 0000 0611 9ea4 0101 0103 0a0a
    0x0020:  0a0a aaaa aadd aaaa aadd aaaa aadd aaaa
    0x0030:  aadd aaaa aadd aaaa aadd aaaa aadd aaaa
```

Dynamic SR Configuration

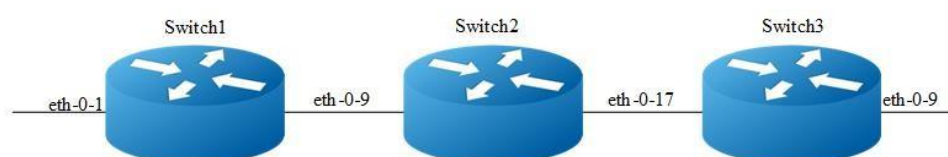

Figure 19-11 MPLS LSP Topo

The following example will describe how to configure dynamic ISIS SR.

step 1 Enter the configure mode

```
Switch# configure terminal
```

step 2 Enter the interface configure mode and set the attributes of the interface**Interface configuration on switch1:**

```
Switch(config)# interface eth-0-1
Switch(config-if)# no switchport
Switch(config-if)# no shutdown
Switch(config-if)# ip address 10.1.1.1/24
Switch(config-if)# exit
Switch(config)# interface eth-0-9
Switch(config-if)# no switchport
Switch(config-if)# no shutdown
Switch(config-if)# ip address 12.1.1.1/24
Switch(config-if)# label-switching
Switch(config-if)# ip router isis
Switch(config-if)# exit
Switch(config)# interface loopback0
Switch(config-if)# ip address 1.1.1.1/32
Switch(config-if)# ip router isis
Switch(config-if)# exit
```

Interface configuration on switch2:

```
Switch(config)# interface eth-0-9
Switch(config-if)# no switchport
Switch(config-if)# no shutdown
Switch(config-if)# ip address 12.1.1.2/24
Switch(config-if)# label-switching
Switch(config-if)# ip router isis
Switch(config-if)# exit
Switch(config)# interface eth-0-17
Switch(config-if)# no switchport
Switch(config-if)# no shutdown
Switch(config-if)# ip address 23.1.1.2/24
Switch(config-if)# label-switching
Switch(config-if)# ip router isis
Switch(config-if)# exit
Switch(config)# interface loopback0
Switch(config-if)# ip address 2.2.2.2/32
Switch(config-if)# ip router isis
Switch(config-if)# exit
```

Interface configuration on switch3:

```
Switch(config)# interface eth-0-17
Switch(config-if)# no switchport
Switch(config-if)# no shutdown
Switch(config-if)# ip address 23.1.1.3/24
Switch(config-if)# label-switching
Switch(config-if)# ip router isis
Switch(config-if)# exit
Switch(config)# interface eth-0-9
Switch(config-if)# no switchport
Switch(config-if)# no shutdown
Switch(config-if)# ip address 34.1.1.3/24
Switch(config-if)# label-switching
Switch(config-if)# ip router isis
Switch(config-if)# exit
Switch(config)# interface loopback0
Switch(config-if)# ip address 3.3.3.3/32
Switch(config-if)# ip router isis
Switch(config-if)# exit

Switch(config)# arp 34.1.1.4 0000.0000.000a
Switch(config)# ip route 5.5.5.5/32 34.1.1.4
```

step 3 Configure router isis and enable segment routing

Router isis configuration on switch1:

```
Switch(config)# router isis
Switch(config)# metric-style wide
Switch(config)# segment-routing mpls
Switch(config)# segment-routing global-block 16000 16999
Switch(config)# net 49.0000.0000.0001.00
Switch(config)# exit
```

Router isis configuration on switch2:

```
Switch(config)# router isis
Switch(config)# metric-style wide
Switch(config)# segment-routing mpls
Switch(config)# segment-routing global-block 17000 17999
Switch(config)# net 49.0000.0000.0002.00
Switch(config)# exit
```

Router isis configuration on switch3:

```
Switch(config)# router isis
Switch(config)# metric-style wide
Switch(config)# segment-routing mpls
Switch(config)# segment-routing global-block 18000 18999
Switch(config)# net 49.0000.0000.0003.00
Switch(config)# exit
```

step 4 Configure prefix sid

```
Switch(config)# interface loopback0
Switch(config-if)# isis prefix-sid index 10
Switch(config-if)# exit
```

```
Switch(config)# interface loopback0
Switch(config-if)# isis prefix-sid index 20
Switch(config-if)# exit
```

```
Switch(config)# interface loopback0
Switch(config-if)# isis prefix-sid index 30
Switch(config-if)# exit
```

step 5 Configure SR LSP

Sr lsp configuration on switch1:

```
Switch(config)# static-sr-mpls lsp lsp1 out-label 16030
```

step 6 Configure SR TUNNEL , bind sr lsp to tunnel and map route to sr tunnel

Sr lsp configuration on switch1:

```
Switch(config)# static-sr-mpls tunnel tun1 non-aps
Switch(config-sr-tunnel)# primary lsp1
Switch(config-sr-tunnel)# map-route 5.5.5.5/32
Switch(config-sr-tunnel)# exit
```

step 7 Validation

Display the isis route on switch1:

```
Switch# show ip isis route

Codes: C - connected, E - external, L1 - IS-IS level-1, L2 - IS-IS level-2
       ia - IS-IS inter area, D - discard, e - external metric

Area (null):
  Destination      Metric      Next-Hop      Interface      Tag
Sid  Nflag Eflag Chg
C    1.1.1.1/32    10          --            loopback0      0
10   Y      N      N
L1   2.2.2.2/32    20          12.1.1.2     eth-0-9        0
20   Y      N      N
L1   3.3.3.3/32    30          12.1.1.2     eth-0-9        0
30   Y      N      N
C    12.1.1.0/24  10          --            eth-0-9        0
```

```
-- -- -- --
L1 23.1.1.0/24          20          12.1.1.2    eth-0-9     0
-- -- -- --
```

Display the prefix segment on switch1:

```
Switch# show mpls sr-prefix
sr-prefix          destination    inlabel    outlabel    nexthop      lsp_list
-                  2.2.2.2/32   16020     17020     12.1.1.2    -
-                  3.3.3.3/32   16030     17030     12.1.1.2    lspl
```

Display the mpls ilm entry on switch1:

```
Switch# show mpls ilm-database
Codes: > - selected ILM, * - LSP ILM, p - stale ILM, B - BGP ILM, K - CLI ILM,
       L - LDP ILM, R - RSVP-TE ILM, S - SNMP ILM, G - IGP-Shortcut, I - ISIS SR
       U - unknown ILM

Code      FEC          I/O Label      Nexthop        Out-Intf
I>        0.0.0.0/0     16010/-        0.0.0.0        N/A
I>        0.0.0.0/0     16020/17020    12.1.1.2       eth-0-9
I>        0.0.0.0/0     16030/17030    12.1.1.2       eth-0-9
```

Display the isis route on switch2:

```
Switch# show ip isis route

Codes: C - connected, E - external, L1 - IS-IS level-1, L2 - IS-IS level-2
       ia - IS-IS inter area, D - discard, e - external metric

Area (null):
  Destination      Metric      Next-Hop      Interface      Tag
Sid  Nflag Eflag Chg
L1  1.1.1.1/32      20          12.1.1.1     eth-0-9        0
10   Y   N   N
C   2.2.2.2/32      10          --           loopback0      0
20   Y   N   N
L1  3.3.3.3/32      20          23.1.1.3     eth-0-17       0
30   Y   N   N
C   12.1.1.0/24     10          --           eth-0-9        0
--   --   --   --
C   23.1.1.0/24     10          --           eth-0-17       0
--   --   --   --
```

Display the prefix segment on switch2:

```
Switch# show mpls sr-prefix
sr-prefix          destination    inlabel    outlabel    nexthop      lsp_list
-                  1.1.1.1/32   17010     16010     12.1.1.1    -
-                  3.3.3.3/32   17030     18030     23.1.1.3    -
```

Display the mpls ilm entry on switch2:

```
Switch# show mpls ilm-database
Codes: > - selected ILM, * - LSP ILM, p - stale ILM, B - BGP ILM, K - CLI ILM,
       L - LDP ILM, R - RSVP-TE ILM, S - SNMP ILM, G - IGP-Shortcut, I - ISIS SR
```

```

      U - unknown ILM

Code      FEC                I/O Label      Nexthop        Out-Intf
I>        0.0.0.0/0          17010/16010    12.1.1.1       eth-0-9
I>        0.0.0.0/0          17020/-        0.0.0.0        N/A
I>        0.0.0.0/0          17030/18030    23.1.1.3       eth-0-17

```

Display the isis route on switch3:

```

Switch# show ip isis route

Codes: C - connected, E - external, L1 - IS-IS level-1, L2 - IS-IS level-2
       ia - IS-IS inter area, D - discard, e - external metric

Area (null):
  Destination      Metric      Next-Hop      Interface      Tag
Sid  Nflag Eflag Chg
L1  1.1.1.1/32      30          23.1.1.2      eth-0-17       0
10   Y      N      N
L1  2.2.2.2/32      20          23.1.1.2      eth-0-17       0
20   Y      N      N
C   3.3.3.3/32      10          --            loopback0      0
30   Y      N      Y
L1  12.1.1.0/24     20          23.1.1.2      eth-0-17       0
--   --      --      --
C   23.1.1.0/24     10          --            eth-0-17       0
--   --      --      --

```

Display the prefix segment on switch3:

```

Switch# show mpls sr-prefix

sr-prefix      destination      inlabel      outlabel      nexthop      lsp_list
-              1.1.1.1/32      18010        17010         23.1.1.2     -
-              2.2.2.2/32      18020        17020         23.1.1.2     -

```

Display the mpls ilm entry on switch3:

```

Switch# show mpls ilm-database

Codes: > - selected ILM, * - LSP ILM, p - stale ILM, B - BGP ILM, K - CLI ILM,
       L - LDP ILM, R - RSVP-TE ILM, S - SNMP ILM, G - IGP-Shortcut, I - ISIS SR
       U - unknown ILM

Code      FEC                I/O Label      Nexthop        Out-Intf
I>        0.0.0.0/0          18010/17010    23.1.1.2       eth-0-17
I>        0.0.0.0/0          18020/17020    23.1.1.2       eth-0-17
I>        0.0.0.0/0          18030/-        0.0.0.0        N/A

```

Display the sr lsp on switch1:

```

Switch# show mpls sr-lsp

b - segment bind, i - install

sr-lsp      id      tunid b i nexthop      tunnel      adj      prefix
isis-prefix  outlabel
lsp1        1       1     1 1 12.1.1.2      tun1       -       -
3.3.3.3/32  16030

```

Display the sr tunnel on switch1:

```
Switch# show mpls sr-tunnel
wlspl - working lsp, plspl - protection lsp, slspl - select lsp
sr-tunnel      id    type  wlspl  plspl  slspl  map-route
tun1           2    non   lsp1   -      -      5.5.5.5/32
```

Display the map-route on switch1:

```
Switch# show mpls sr-mapped-routes
Mapped-route   is_install SR-Tunnel-name
5.5.5.5/32     yes        tun1
```

Send packets with destination ip address 5.5.5.5 to eth-0-1 on switch1:**Capture packets received on eth-0-1 on switch1:**

```
07:09:42.985391 00:00:00:00:00:02 (oui Ethernet) > 22:92:11:2e:47:00 (oui Unknown),
ethertype IPv4 (0x0800), length 64: (tos 0x0, ttl 10, id 0, offset 0, flags [none],
proto UDP (17), length 50)
    1.1.1.3.43690 > 5.5.5.5.43741: [bad udp cksum 0xaadd -> 0x9d3b!] UDP, length
43682
    0x0000:  2292 112e 4700 0000 0000 0002 0800 4500
    0x0010:  0032 0000 0000 0a11 a4ae 0101 0103 0505
    0x0020:  0505 aaaa aadd aaaa aadd aaaa aadd aaaa
    0x0030:  aadd aaaa aadd aaaa aadd aaaa aadd aaaa
```

Capture packets sented on eth-0-9 on switch1:

```
07:10:39.037569 22:92:11:2e:47:00 (oui Unknown) > 2c:ad:5e:70:52:00 (oui Unknown),
ethertype MPLS unicast (0x8847), length 68: MPLS (label 17030, exp 0, [S], ttl 9)
(tos 0x0, ttl 9, id 0, offset 0, flags [none], proto UDP (17), length 50)
    1.1.1.3.43690 > 5.5.5.5.43741: [bad udp cksum 0xaadd -> 0x9d3b!] UDP, length
43682
    0x0000:  2cad 5e70 5200 2292 112e 4700 8847 0428
    0x0010:  6109 4500 0032 0000 0000 0911 a5ae 0101
    0x0020:  0103 0505 0505 aaaa aadd aaaa aadd aaaa
    0x0030:  aadd aaaa aadd aaaa aadd aaaa aadd aaaa
    0x0040:  aadd aaaa
```

Capture packets sented on eth-0-17 on switch2:

```
07:11:31.922016 2c:ad:5e:70:52:00 (oui Unknown) > 4e:1d:de:29:f9:00 (oui Unknown),
ethertype MPLS unicast (0x8847), length 68: MPLS (label 18030, exp 0, [S], ttl 8)
(tos 0x0, ttl 9, id 0, offset 0, flags [none], proto UDP (17), length 50)
    1.1.1.3.43690 > 5.5.5.5.43741: [bad udp cksum 0xaadd -> 0x9d3b!] UDP, length
43682
    0x0000:  4e1d de29 f900 2cad 5e70 5200 8847 0466
    0x0010:  e108 4500 0032 0000 0000 0911 a5ae 0101
    0x0020:  0103 0505 0505 aaaa aadd aaaa aadd aaaa
    0x0030:  aadd aaaa aadd aaaa aadd aaaa aadd aaaa
    0x0040:  aadd aaaa
```

Capture packets sented on eth-0-9 on switch3:

```
07:23:09.891084 4e:1d:de:29:f9:00 (oui Unknown) > 00:00:00:00:00:0a (oui Ethernet),  
ethertype IPv4 (0x0800), length 64: (tos 0x0, ttl 7, id 0, offset 0, flags [none],  
proto UDP (17), length 50)  
  1.1.1.3.43690 > 5.5.5.5.43741: [bad udp cksum 0xaadd -> 0x9d3b!] UDP, length  
43682  
    0x0000:  0000 0000 000a 4e1d de29 f900 0800 4500  
    0x0010:  0032 0000 0000 0711 a7ae 0101 0103 0505  
    0x0020:  0505 aaaa aadd aaaa aadd aaaa aadd aaaa  
    0x0030:  aadd aaaa aadd aaaa aadd aaaa aadd aaaa
```

20 PoE

20.1 PoE Overview

PoE (Power over Ethernet, remote power supply): It is a mechanism for supplying power to a PD (Powered Device) connected remotely through the Ethernet to realize parallel power supply and data transmission. Common PD devices include IP phones, wireless APs, IP cameras, and various new IoT terminal devices. PoE technology is widely used for its characteristics of centralized power supply, centralized management, convenient installation, and unified software and hardware standards.

PoE system involves the following devices:

PSE (Power-Sourcing Equipment): A PSE is a PoE device that provides power to PDs and supports detection, analysis, and intelligent power management.

PD (Power Device): A PD is a device that receives power from a PSE. PDs are classified into standard and non-standard PDs depending on whether they conform to IEEE standards: 802.3af, 802.3at, 802.3bt.

PoE power supply: A PoE power supply provides power to a PoE system. The number of PDs connected to a PSE is limited by the power output of the PoE power supply.

20.2 features and configurations

20.2.1 Configuring Global PoE power management scheme

Configure the switch power management scheme in global configuration mode, including the power limit mode and power policy for PoE ports.

limit-mode: Power limit mode. The port power can be allocated based on the PD class automatically detected by the PoE port, or the port power can be allocated

according to the max-power parameter configured by the user on the port. The port allocation power values corresponding to different categories are as follows:

class	power limit (W)
1	4
2	7
3	15.4
4	30
5	45
6	60
7	75
8	90

policy: Power allocation policy. There are two strategies: dynamic and static. When configured as dynamic, the remaining available power is calculated from the total PoE power allocable power minus the actual power allocated by all ports. Then decide whether to supply power to the newly connected PD according to the remaining available power and the current power consumption of the newly connected PD; when the configuration is static, the system calculates the maximum power supply power of each port in use according to limit-mode and reserves power for it. Then, it is determined whether to supply power to the newly connected PD according to the remaining available power and the current power consumption of the newly connected PD.

Autoclass: When configuring the static power allocation policy, you can choose whether to enable the autoclass function. If autoclass is enabled and the PD also supports the autoclass function, the power can be reserved for the port more reasonably through the negotiation between the PSE and the PD, so as to avoid the waste of reserving too much power for low-power loads, and rational use of resources can be used in more supply power to the PD on the interface.

SwitchA# configure terminal	Enter configuration mode
Switch(config)# poe power-management limit-mode class	Configure the power limit mode of each interface to use the class-based power limit mode.
Switch(config)# poe power-management policy static autoclass enable	Configure the power management policy as static and enable the autoclass function. If the PD supports this function, it is more reasonable to reserve power.

For example, the power limit mode in the three PoE configurations is also "based on port's configured max power". However, when the "power policy" is dynamic, static, and static, the auto class function is enabled at the same time. When comparing the "granted power", "power limit", and "available power" in the "PoE status" and "PoE summary" in the above three configurations, you can more intuitively see the difference in power distribution results. The following are examples of configuration and status display:

```

Switch# configure terminal
Switch(config)# poe power-management limit-mode class
Switch(config)# end
Switch# show poe status
Codes : IF - interface CH - channel ST - enable status
MD - mode CL - class PR - priority
V - voltage (V) mA - current (mA) TP - temperature ('C)
GT - granted power (W) LM - power limit (W) CS - consumption (W)
AP - available power (W)
DIS - disable EN - enable
CR - critical HI - high LO - low
OP - operation status of poe
+-----+-----+-----+-----+-----+-----+-----+-----+-----+-----+-----+-----+-----+-----+-----+
IF          ST  OP  MD      CL PR  V      mA TP GT      LM      CS      AP
eth-0-1     EN  OFF POE_BT -- LO 0.0 0    36 0.000 --      0.000 --
eth-0-2     EN  OFF POE_BT -- LO 0.0 0    36 0.000 --      0.000 --
eth-0-3     EN  OFF POE_BT -- LO 0.0 0    36 0.000 --      0.000 --
eth-0-4     EN  OFF POE_BT -- LO 0.0 0    36 0.000 --      0.000 --
eth-0-5     EN  OFF POE_BT -- LO 0.0 0    36 0.000 --      0.000 --
eth-0-6     EN  OFF POE_BT -- LO 0.0 0    37 0.000 --      0.000 --
eth-0-7     EN  OFF POE_BT -- LO 0.0 0    37 0.000 --      0.000 --
eth-0-8     EN  OFF POE_BT -- LO 0.0 0    37 0.000 --      0.000 --
eth-0-9     EN  ON  POE_BT 8  LO 54.6 679 37 37.254 41.000 37.055 3.945
eth-0-10    EN  OFF POE_BT -- LO 0.0 0    39 0.000 --      0.000 --
eth-0-11    EN  OFF POE_BT -- LO 0.0 0    39 0.000 --      0.000 --
eth-0-12    EN  OFF POE_BT -- LO 0.0 0    39 0.000 --      0.000 --
eth-0-13    EN  ON  POE_BT 6  LO 54.7 34  39 1.639 60.000 1.858 58.142
eth-0-14    EN  OFF POE_BT -- LO 0.0 0    41 0.000 --      0.000 --
eth-0-15    EN  OFF POE_BT -- LO 0.0 0    41 0.000 --      0.000 --
eth-0-16    EN  OFF POE_BT -- LO 0.0 0    41 0.000 --      0.000 --
eth-0-17    EN  OFF POE_BT -- LO 0.0 0    41 0.000 --      0.000 --
eth-0-18    EN  OFF POE_BT -- LO 0.0 0    43 0.000 --      0.000 --
eth-0-19    EN  ON  POE_BT 4  LO 54.5 33  43 1.797 30.000 1.797 28.203
eth-0-20    EN  OFF POE_BT -- LO 0.0 0    43 0.000 --      0.000 --
eth-0-21    EN  OFF POE_BT -- LO 0.0 0    43 0.000 --      0.000 --
eth-0-22    EN  OFF POE_BT -- LO 0.0 0    41 0.000 --      0.000 --
eth-0-23    EN  OFF POE_BT -- LO 0.0 0    41 0.000 --      0.000 --
eth-0-24    EN  OFF POE_BT -- LO 0.0 0    41 0.000 --      0.000 --

Switch# show poe summary
-----
Power Source Equipment NO: 1
Operation status: enable
Channel Num for power: 48

```

```

PSE Firmware Version: Ve0.17.36.01
PSE SRAM Patch Version: 0x0
PSE PSU Information
    PSU1: Absent
    PSU2: 400 W Present
PSE Power Policy: Dynamic
PSE Power Limit Mode: Class Based Limit
PSE Legacy PD Enable: Disable
Power Limit: 400000 mW
Power Available: 359094 mW
Power Actual Consump: 40483 mW
Power Allocated: 40906 mW
Power Reserved: 30000 mW
Power Threshold: 90%
PSE Reserved Power Alert: -
PSE Threshold Power Alert: -
PSE Device Temperature
    Device 0: 39 degC
    Device 1: 39 degC
    Device 2: 41 degC
    Device 3: 39 degC
    Device 4: 40 degC
    Device 5: 42 degC
PSE Device Faults
    SRAM Fault: -
    TSD Fault: -
    VPWR Fault: -
    VDD Fault: -

Switch#
Switch# configure terminal
Switch(config)# poe power-management policy dynamic
Switch(config)# end
Switch# show poe status
Codes : IF - interface  CH - channel  ST - enable status
        MD - mode       CL - class   PR - priority
        V - voltage(V)   mA - current(mA)   TP - temperature('C)
        GT - granted power(W)  LM - power limit(W)  CS - consumption(W)
        AP - available power(W)
        DIS - disable  EN - enable
        CR - critical  HI - high      LO - low
        OP - operation status of poe
+-----+-----+-----+-----+-----+-----+-----+-----+-----+-----+-----+-----+-----+
IF          ST  OP  MD  CL  PR  V    mA  TP  GT    LM    CS    AP
eth-0-1    EN  OFF POE_BT -- LO  0.0  0   36  0.000  --    0.000  --
eth-0-2    EN  OFF POE_BT -- LO  0.0  0   36  0.000  --    0.000  --
eth-0-3    EN  OFF POE_BT -- LO  0.0  0   36  0.000  --    0.000  --
eth-0-4    EN  OFF POE_BT -- LO  0.0  0   36  0.000  --    0.000  --
eth-0-5    EN  OFF POE_BT -- LO  0.0  0   36  0.000  --    0.000  --
eth-0-6    EN  OFF POE_BT -- LO  0.0  0   39  0.000  --    0.000  --
eth-0-7    EN  OFF POE_BT -- LO  0.0  0   39  0.000  --    0.000  --
eth-0-8    EN  OFF POE_BT -- LO  0.0  0   39  0.000  --    0.000  --
eth-0-9    EN  ON  POE_BT 8  LO  54.9  679  39  37.099  41.000  37.267  3.733
eth-0-10   EN  OFF POE_BT -- LO  0.0  0   39  0.000  --    0.000  --
eth-0-11   EN  OFF POE_BT -- LO  0.0  0   39  0.000  --    0.000  --
eth-0-12   EN  OFF POE_BT -- LO  0.0  0   39  0.000  --    0.000  --
    
```

```

eth-0-13  EN  ON  POE_BT 6  LO  54.7 34  39  1.847  90.000  1.858  88.142
eth-0-14  EN  OFF POE_BT --  LO  0.0  0  39  0.000  --  0.000  --
eth-0-15  EN  OFF POE_BT --  LO  0.0  0  39  0.000  --  0.000  --
eth-0-16  EN  OFF POE_BT --  LO  0.0  0  39  0.000  --  0.000  --
eth-0-17  EN  OFF POE_BT --  LO  0.0  0  39  0.000  --  0.000  --
eth-0-18  EN  OFF POE_BT --  LO  0.0  0  42  0.000  --  0.000  --
eth-0-19  EN  ON  POE_BT 4  LO  54.5 34  42  1.797  75.000  1.852  73.148
eth-0-20  EN  OFF POE_BT --  LO  0.0  0  42  0.000  --  0.000  --
eth-0-21  EN  OFF POE_BT --  LO  0.0  0  42  0.000  --  0.000  --
eth-0-22  EN  OFF POE_BT --  LO  0.0  0  40  0.000  --  0.000  --
eth-0-23  EN  OFF POE_BT --  LO  0.0  0  40  0.000  --  0.000  --
eth-0-24  EN  OFF POE_BT --  LO  0.0  0  40  0.000  --  0.000  --

```

```
Switch# show poe summary
```

```

-----
Power Source Equipment NO: 1
Operation status: enable
Channel Num for power: 48
PSE Firmware Version: Ve0.17.36.01
PSE SRAM Patch Version: 0x0
PSE PSU Information
    PSU1: Absent
    PSU2: 400 W Present
PSE Power Policy: Dynamic
PSE Power Limit Mode: Port Based Limit
PSE Legacy PD Enable: Disable
Power Limit: 400000 mW
Power Available: 359186 mW
Power Actual Consump: 40977 mW
Power Allocated: 40814 mW
Power Reserved: 30000 mW
Power Threshold: 90%
PSE Reserved Power Alert: -
PSE Threshold Power Alert: -
PSE Device Temperature
    Device 0: 36 degC
    Device 1: 36 degC
    Device 2: 39 degC
    Device 3: 39 degC
    Device 4: 39 degC
    Device 5: 42 degC
PSE Device Faults
    SRAM Fault: -
    TSD Fault: -
    VPWR Fault: -
    VDD Fault: -
Switch#
Switch# configure terminal
Switch(config)# poe power-management limit-mode port
Switch(config)# poe power-management policy static autoclass enable
Switch(config)# end
Switch# show poe status
Codes : IF - interface  CH - channel  ST - enable status
        MD - mode       CL - class   PR - priority
        V - voltage(V)   mA - current(mA)   TP - temperature('C)

```

```

GT - granted power(W)   LM - power limit(W)   CS - consumption(W)
AP - available power(W)
DIS - disable   EN - enable
CR - critical   HI - high   LO - low
OP - operation status of poe
+-----+-----+-----+-----+-----+-----+-----+-----+-----+-----+-----+-----+-----+-----+
IF          ST   OP   MD      CL PR  V      mA TP GT      LM      CS      AP
eth-0-1    EN   OFF POE_BT -- LO 0.0 0      36 0.000 --      0.000 --
eth-0-2    EN   OFF POE_BT -- LO 0.0 0      36 0.000 --      0.000 --
eth-0-3    EN   OFF POE_BT -- LO 0.0 0      36 0.000 --      0.000 --
eth-0-4    EN   OFF POE_BT -- LO 0.0 0      36 0.000 --      0.000 --
eth-0-5    EN   OFF POE_BT -- LO 0.0 0      36 0.000 --      0.000 --
eth-0-6    EN   OFF POE_BT -- LO 0.0 0      39 0.000 --      0.000 --
eth-0-7    EN   OFF POE_BT -- LO 0.0 0      39 0.000 --      0.000 --
eth-0-8    EN   OFF POE_BT -- LO 0.0 0      39 0.000 --      0.000 --
eth-0-9    EN   ON   POE_BT 8   LO 54.6 679 39 38.000 41.000 37.053 3.947
eth-0-10   EN   OFF POE_BT -- LO 0.0 0      39 0.000 --      0.000 --
eth-0-11   EN   OFF POE_BT -- LO 0.0 0      39 0.000 --      0.000 --
eth-0-12   EN   OFF POE_BT -- LO 0.0 0      39 0.000 --      0.000 --
eth-0-13   EN   ON   POE_BT 6   LO 54.4 34  39 90.000 90.000 1.847 88.153
eth-0-14   EN   OFF POE_BT -- LO 0.0 0      41 0.000 --      0.000 --
eth-0-15   EN   OFF POE_BT -- LO 0.0 0      41 0.000 --      0.000 --
eth-0-16   EN   OFF POE_BT -- LO 0.0 0      41 0.000 --      0.000 --
eth-0-17   EN   OFF POE_BT -- LO 0.0 0      41 0.000 --      0.000 --
eth-0-18   EN   OFF POE_BT -- LO 0.0 0      42 0.000 --      0.000 --
eth-0-19   EN   ON   POE_BT 4   LO 54.5 33  42 75.000 75.000 1.798 73.202
eth-0-20   EN   OFF POE_BT -- LO 0.0 0      42 0.000 --      0.000 --
eth-0-21   EN   OFF POE_BT -- LO 0.0 0      42 0.000 --      0.000 --
eth-0-22   EN   OFF POE_BT -- LO 0.0 0      41 0.000 --      0.000 --
eth-0-23   EN   OFF POE_BT -- LO 0.0 0      41 0.000 --      0.000 --
eth-0-24   EN   OFF POE_BT -- LO 0.0 0      41 0.000 --      0.000 --

Switch# show poe summary
-----
Power Source Equipment NO: 1
Operation status: enable
Channel Num for power: 48
PSE Firmware Version: Ve0.17.36.01
PSE SRAM Patch Version: 0x0
PSE PSU Information
  PSU1: Absent
  PSU2: 400 W Present
PSE Power Policy: Static w/ Autoclass
PSE Power Limit Mode: Port Based Limit
PSE Legacy PD Enable: Disable
Power Limit: 400000 mW
Power Available: 197000 mW
Power Actual Consump: 40907 mW
Power Allocated: 203000 mW
Power Reserved: 30000 mW
Power Threshold: 90%
PSE Reserved Power Alert: -
PSE Threshold Power Alert: -
PSE Device Temperature
  Device 0: 35 degC

```

```

Device 1: 35 degC
Device 2: 39 degC
Device 3: 39 degC
Device 4: 40 degC
Device 5: 43 degC
PSE Device Faults
  SRAM Fault: -
  TSD Fault: -
  VPWR Fault: -
  VDD Fault: -
Switch# configure terminal
Switch(config)# poe power-management policy static autoclass disable
Switch(config)# end
Switch# show poe status
Codes : IF - interface  CH - channel  ST - enable status
        MD - mode       CL - class   PR - priority
        V - voltage(V)  mA - current(mA)  TP - temperature('C)
        GT - granted power(W)  LM - power limit(W)  CS - consumption(W)
        AP - available power(W)
        DIS - disable  EN - enable
        CR - critical  HI - high      LO - low
        OP - operation status of poe
+-----+-----+-----+-----+-----+-----+-----+-----+-----+-----+-----+-----+-----+
IF          ST  OP  MD      CL PR V      mA TP GT      LM      CS      AP
eth-0-1    EN  OFF POE_BT -- LO 0.0 0      34 0.000 --      0.000 --
eth-0-2    EN  OFF POE_BT -- LO 0.0 0      34 0.000 --      0.000 --
eth-0-3    EN  OFF POE_BT -- LO 0.0 0      34 0.000 --      0.000 --
eth-0-4    EN  OFF POE_BT -- LO 0.0 0      34 0.000 --      0.000 --
eth-0-5    EN  OFF POE_BT -- LO 0.0 0      34 0.000 --      0.000 --
eth-0-6    EN  OFF POE_BT -- LO 0.0 0      39 0.000 --      0.000 --
eth-0-7    EN  OFF POE_BT -- LO 0.0 0      39 0.000 --      0.000 --
eth-0-8    EN  OFF POE_BT -- LO 0.0 0      39 0.000 --      0.000 --
eth-0-9    EN  ON  POE_BT 8  LO 54.9 679 39 90.000 41.000 37.259 3.741
eth-0-10   EN  OFF POE_BT -- LO 0.0 0      39 0.000 --      0.000 --
eth-0-11   EN  OFF POE_BT -- LO 0.0 0      39 0.000 --      0.000 --
eth-0-12   EN  OFF POE_BT -- LO 0.0 0      39 0.000 --      0.000 --
eth-0-13   EN  ON  POE_BT 6  LO 54.4 34 39 90.000 90.000 1.847 88.153
eth-0-14   EN  OFF POE_BT -- LO 0.0 0      40 0.000 --      0.000 --
eth-0-15   EN  OFF POE_BT -- LO 0.0 0      40 0.000 --      0.000 --
eth-0-16   EN  OFF POE_BT -- LO 0.0 0      40 0.000 --      0.000 --
eth-0-17   EN  OFF POE_BT -- LO 0.0 0      40 0.000 --      0.000 --
eth-0-18   EN  OFF POE_BT -- LO 0.0 0      42 0.000 --      0.000 --
eth-0-19   EN  ON  POE_BT 4  LO 54.5 33 42 75.000 75.000 1.797 73.203
eth-0-20   EN  OFF POE_BT -- LO 0.0 0      42 0.000 --      0.000 --
eth-0-21   EN  OFF POE_BT -- LO 0.0 0      42 0.000 --      0.000 --
eth-0-22   EN  OFF POE_BT -- LO 0.0 0      41 0.000 --      0.000 --
eth-0-23   EN  OFF POE_BT -- LO 0.0 0      41 0.000 --      0.000 --
eth-0-24   EN  OFF POE_BT -- LO 0.0 0      41 0.000 --      0.000 --

Switch# show poe summary
-----
Power Source Equipment NO: 1
Operation status: enable
Channel Num for power: 48
PSE Firmware Version: Ve0.17.36.01

```

```

PSE SRAM Patch Version: 0x0
PSE PSU Information
    PSU1: Absent
    PSU2: 400 W Present
PSE Power Policy: Static w/o Autoclass
PSE Power Limit Mode: Port Based Limit
PSE Legacy PD Enable: Disable
Power Limit: 400000 mW
Power Available: 145000 mW
Power Actual Consump: 40903 mW
Power Allocated: 255000 mW
Power Reserved: 30000 mW
Power Threshold: 90%
PSE Reserved Power Alert: -
PSE Threshold Power Alert: -
PSE Device Temperature
    Device 0: 36 degC
    Device 1: 36 degC
    Device 2: 39 degC
    Device 3: 39 degC
    Device 4: 41 degC
    Device 5: 42 degC
PSE Device Faults
    SRAM Fault: -
    TSD Fault: -
    VPWR Fault: -
    VDD Fault: -
Switch#

```

Usually, we configure the limit-mode as class and the policy as dynamic to reasonably allocate the system power and ensure that as many PD devices are connected as possible. However, if the power of the PD device fluctuates greatly during use, the power supply policy needs to be configured according to the actual situation to avoid unpredictable changes between power supply and power failure of some devices due to insufficient power.

20.2.2 Configuring power-reserved

The power-reserved is to reserve a part of the allocable power of the PoE power supply as the PoE power supply protection of the whole machine. When the remaining power of the system is less than the reserved protection power, it will no longer supply power to the newly connected PD devices. At the same time, the PoE state light of the front panel is on orange.

SwitchA# configure terminal	Enter configuration mode
Switch(config)# poe power-reserved 60000	Configure reserved-power of poe to 60000mW.default: 30000.

20.2.3 Configure threshold-power-percentage

You can configure the alarm threshold for real-time PoE power consumption. When the total real-time power consumption exceeds or falls below the alarm threshold for the first time, the system will prompt the user. This threshold is also used to determine the state of the PoE LED on the front panel of the switch. If the power consumption does not exceed the alarm threshold, the PoE LED turns green; if the power consumption exceeds the alarm threshold, it turns orange.

SwitchA# configure terminal	Enter configuration mode
Switch(config)# poe power-threshold 85	Configure threshold-power-percentage of poe to 85%.Default: 90%.

20.2.4 Enable port PoE feature

For a ports that supports the PoE function, you can enable or disable the PoE function of the ports in the port configuration mode. You can also attach the time-range to formulate a power supply task for the PoE port(s) to supply or not supply power in a specific time period.

SwitchA# configure terminal Switch(config)# interface eth-0-9	Enter configuration mode
Switch(config-if)# poe disable Switch(config-if)# poe enable time-range plan1	Configure this port to supply power during the time period defined by “plan1”, and not supply power at other times. Default:enable.

20.2.5 Configuring the Power Supply Priority

Reasonable configuration of the power supply priority of the PoE ports, combined with the configuration of the global power-management scheme in the previous section, can guarantee the power supply to more important PD to a limited extent when the external power supply of the switch is close to or exceeds the full load.

The PoE power supply priority of a port is critical, high, and low from high to low. The default priority of all POE ports is low. When a new PD device is connected to a port with a higher priority when the external power supply is fully loaded, the PSE will power off the PD connected to the port with a lower priority, and then supply power to the newly connected PD; If all ports have the same priority, the PD connected to the port with the smaller port number is given priority to supply power.

SwitchA# configure terminal Switch(config)# interface eth-0-9	Enter configuration mode
--	--------------------------

Switch(config-if)# poe priority critical	Configure the power supply priority of the port to be the highest:critical.
--	---

20.2.6 Trigger an autoclass measurement

In the interface configuration mode, the autoclass can be manually triggered to measure the power of the PD, and then a more reasonable power limit parameter can be set for the port according to the measured result, so as to allocate the power of the whole machine more reasonably.

SwitchA# configure terminal Switch(config)# interface eth-0-9	Enter interface configuration mode
Switch(config-if)# poe autoclass ch1 ch2 adjustment ch1 ch2	Trigger port eth-0-9 to restart autoclass power measurement manually and adjust the max-power value on channel 1 and 2:

20.3 Example for Configuring PoE

Networking Requirements

In an office network, port 1 of the PoE switch is connected to the wireless AP in the company lobby to provide Wi-Fi services for guests, and needs to maintain power supply during working hours; ports 5 and 6 are connected to IP phones of business departments, and require the highest priority power supply; Ports 7 and 8 are connected to wireless APs to provide WiFi coverage for office areas, and require the second highest priority power supply; port 24 is connected to a IP camera, and also requires the highest priority power supply. The power distribution is dynamically adjusted according to the actual power output.

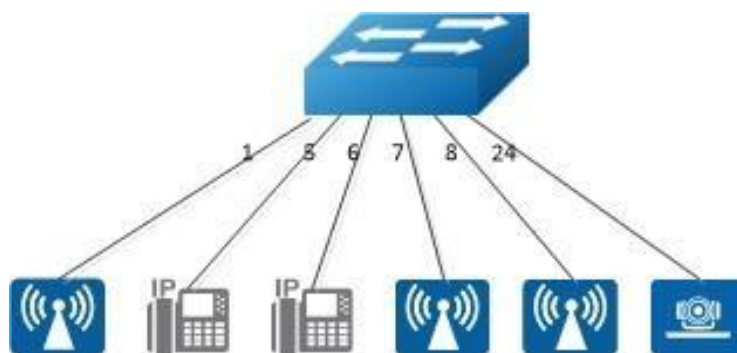

Figure 20-1 PoE

Procedure

#Define a time-range entry for working hours:

```
Switch# configure terminal
Switch(config)# time-range working
Switch(config-tm-range)# periodic 8:30 daily to 18:30
Switch(config-tm-range)# exit
```

#Configuring a global power management scheme:

```
Switch(config)# poe power-management policy dynamic
Switch(config)# poe power-management limit-mode class
```

#Configuring the PoE Power Supply Policy for the ports:

```
Switch(config)# interface eth-0-1
Switch(config-if)# poe disable
Switch(config-if)# poe enable time-range working
Switch(config-if)# exit
Switch(config)# interface range eth-0-5 - 6
Switch(config-if-range)# poe priority critical
Switch(config-if-range)# poe enable
Switch(config-if-range)# exit
Switch(config)# interface eth-0-24
Switch(config-if)# poe priority critical
Switch(config-if)# poe enable
Switch(config-if)# exit
Switch(config)# interface range eth-0-7 - 8
Switch(config-if-range)# poe priority high
Switch(config-if-range)# poe enable
Switch(config-if-range)# exit
Switch(config)#exit
Switch#
```

#Save the configuration:

```
Switch# write
Switch#
```